



Living

Chroom - Chrome - Chrom - Chromé

Nikkel - Nickel - Vernickelt - Nicklé

Nikkel mat - Satin nickel - Nickel matt - Nicklé mat

Mat zwart - Satin black - Matt Schwarz - Noire mat

Vintage & Retro 2



Living

Vintage & Retro 2

INTERSTEEL Living

Intersteel beheerst de kunst van het koppelen van moderne technologieën aan elegant design. Voor elke woonstijl bestaat wel een productlijn die een extra element toevoegt aan het interieurdesign. De producten uit de Living collectie passen bij veel interieurstijlen en -smaken: modern & strak, landelijk & klassiek of vintage & retro. De Living collectie bestaat uit producten met een hoge kwaliteit in diverse kleuren zoals roestvast staal, messing, zwart, nikkel en meer. Geef deuren en ramen een eigen finishing touch met de producten uit de Living collectie.



Intersteel commands the art of linking modern technology to elegant design. For each interior style, there is a line of products that add an extra touch to the interior design. The products of the Living collection fit in with many interior styles and tastes: modern and clean-cut, rustic and classic or vintage and retro. The Living collection consists of high-quality products in various colours such as stainless steel, brass, black, nickel, and many more. Use the products of the Living collection to give your windows and doors a personal finishing touch.

Intersteel beherrscht die Kunst der Verbindung von modernen Technologien und elegantem Design. Für jeden Wohnstil gibt es eine Produktlinie, die dem Einrichtungsdesign ein besonderes Element hinzufügt. Die Produkte aus der Living-Kollektion passen zu vielen Einrichtungsstilen und -geschmäckern: modern & geradlinig, ländlich & klassisch oder Vintage & Retro. Die Living-Kollektion besteht aus hochwertigen Produkten in unterschiedlichen Farben wie Edelstahl, Messing, Schwarz-Nickel und mehr. Verleihen Sie Türen und Fenstern mit den Produkten aus der Living-Kollektion eine ganz besondere Oberfläche.

Intersteel maîtrise l'art d'associer les technologies modernes à un design élégant. Pour chaque style d'intérieur, il y a une ligne de produits qui ajoute un élément supplémentaire à la décoration. La collection Living s'associe avec beaucoup de goûts et styles: moderne/sobre, rustique/classique ou vintage/réto. Elle est composée de produits de haute qualité dans des matériaux avec des couleurs diverses tels que l'acier inoxydable, le laiton, le nickel, le noir etc. Donnez une touche de finition personnelle à vos portes et fenêtres grâce aux produits de la collection Living.





De kwaliteit van Intersteel Living kenmerkt zich door:

- Getest EN 1906 - Klasse 4, indien aangegeven.
- Toepasbaar in elk project van luxe woningbouw tot utiliteitsbouw
- Keurige verpakking en geleverd inclusief bevestigingsmateriaal
- Prima prijs/kwaliteit verhouding.
- Veel referentieprojecten in Nederland, Europa, Rusland en het Midden-Oosten.

The quality of INTERSTEEL Living is characterized by:

- Tested EN 1906 - class 4, if indicated
- Availability on rose or on plate with spring
- Suitability for any project involving homes and public buildings
- Good packaging and delivery including fixing materials
- Strong price/quality ratio
- Multiple projects in the Netherlands but also abroad: in Europe, Russia and Middle Eastern countries.

Die Qualität von INTERSTEEL Essentials kennzeichnet sich aus durch:

- Getestet nach EN 1906 Klasse 4, wenn angegeben
- An jedes Objekt wie gehobenen Wohnungsbau oder Individualbau anpassbar
- Hochwertige Verpackung inkl. Befestigungsmaterial
- Gutes Preis-/ Leistungsverhältnis
- Viele Referenzobjekte in den Niederlanden, Europa, Russland und dem mittleren Osten.

La qualité de la gamme INTERSTEEL Living se caractérise comme suit:

- Testée EN 1906 - catégorie 4, si indiqué
- Utilisable dans tout programme immobilier, du logement privé au bâtiment public
- Emballage soigné, éléments de fixation compris
- Excellent rapport qualité / prix
- Nombreux programmes de référence aux Pays-Bas, en Europe, en Russie et jusqu'au Moyen-Orient.

Wat zijn de voordelen voor u als consument?

- Duurzaamheid
- Bewezen kwaliteit
- Eenvoudige en stevige montage door onder andere gebruik van nokken
- Inclusief bevestigingsmateriaal
- Snelle levertijd
- 10 jaar functionaliteitsgarantie.

What are the advantages for you as our customer?

- Durability
- Proven quality
- Many technical solutions
- Simple and strong assembly by means of lugs
- Including fixing materials
- Quick delivery
- Ten year warranty of functionality.

Welche Vorteile haben Sie als Verbraucher?

- Dauerhaftigkeit
- Getestete Qualität
- Einfache Montage durch Nutzung von Montagenocken
- Befestigungsmaterial im Lieferumfang enthalten
- Kurze Lieferzeiten
- 10 Jahre Funktionsgarantie

Quels sont les avantages pour le client ?

- Durabilité
- Qualité prouvée
- Installation simple et montage résistant grâce aux tenons utilisés
- Fixations fournies
- Livraison rapide
- Garantie de fonctionnement de 10 ans.

Wat zijn de voordelen voor onze dealers?

- Een duurzaam product
- Goede kwaliteit - wordt al meer dan 20 jaar volgens de huidige set up gemaakt en toegepast
- Vele technische oplossingen
- Eenvoudige en stevige montage
- Direct uit voorraad leverbaar (24 uren levering binnen Nederland)
- Goede ondersteuning door sterke INTERSTEEL merkuitstraling en professionele marketingactiviteiten
- Gezamenlijke projectbewerking (bestekservice en bezoeken)
- Gratis catalogi
- 10 jaar functionaliteitsgarantie.

What are the advantages for our dealers?

- Durability
- Good quality for over twenty years made and adapted according to the current set up
- Many technical solutions
- Simple and strong assembly
- Directly available from stock
- Support through strong INTERSTEEL brand identity and professional marketing activities
- Collaborative projects
- Free catalogues
- Ten year warranty of functionality.

Welche Vorteile haben Sie als Fachhändler?

- Ein langlebiges Produkt
- Getestete Qualität. Diese wird seit über 20 Jahren unter dem aktuellen Stand der Technik hergestellt und angewendet
- Viele technische Lösungen
- Einfache Montage durch Nutzung von Montagenocken
- Direkt ab Lager lieferbar
- Durch unsere professionelles Marketing und die starke Marke INTERSTEEL, ermöglichen wir Ihnen eine gute Vertriebsunterstützung
- Gemeinsame Projektbetreuung (Bemusterung und Besuch durch den Außendienst)
- Gratis Kataloge
- 10 Jahre Funktionsgarantie

Quels sont les avantages pour nos revendeurs?

- Durabilité de nos produits
- De bonne qualité, le concept actuel de production et d'utilisation a plus de 20 ans d'expérience.
- De nombreuses solutions techniques
- Montage simple et résistant
- Disponibilité en stock (livraison aux Pays-Bas dans les 24 heures)
- Fourniture possible de matériel publicitaire et promotionnel de la marque INTERSTEEL
- Collaboration sur des projets
- Catalogues gratuits
- Garantie de fonctionnement de 10 ans.

Onderhoud

Alle artikelen in deze catalogus zijn door gebruik, aan slijtage onderhevig. Afhankelijk van de gebruiksfrequentie en omgeving zal er uiteindelijk oppervlaktecorrosie (vliegroeft) optreden. Rost dat niet afkomstig is vanuit het materiaal zelf, maar zich van buitenaf op het oppervlak vormt.

Om deze corrosie te voorkomen, dienen de producten regelmatig onderhouden te worden. Eens per week afnemen met een vochtige doek volstaat in de meeste gevallen. Gebruik geen agressieve reinigings- of schuurmiddelen.

- Juiste montage en correct gebruik van de producten
- Defecten aan ramen en deuren (zoals klemmen) direct verhelpen
- Bij schuur- en schilderwerkzaamheden te allen tijde het beslag verwijderen
- Beschermende maatregelen nemen, zoals het plaatsen van deurstoppers.

Maintenance

All products in this catalogue are subject to erosion through use. Depending on the frequency of use and environment eventually rust may occur onto the surface. Rust which does not come off the product but from the product's environment.

To avoid this erosion the products need to be maintained carefully. Please clean your product once a week with a moisty piece of cloth. Do not use aggressive cleaners or abrasives.

- Precise assembly and correct use of the products
- Defects onto windows and doors need direct repair
- When sanding or painting activities involved, always remove the hardware
- Always provide protective measures such as door stoppers.

Pflege

Alle Artikel aus diesem Katalog können durch den ständigen Gebrauch abnutzen. Abhängig von der Umgebung oder mechanischer Einwirkung kann Korrosion entstehen. Rost, der nicht aus dem Material selbst, sondern von außen an die Beschläge herangetragen wird, kann vermieden werden, wenn ein regelmäßiges Abreiben mit einem feuchten Tuch, möglichst einmal wöchentlich erfolgt. Bitte verwenden Sie keine aggressiven Reinigungsmittel und keine Schleifmittel. Bitte beachten Sie folgende Hinweise:

- Bitte achten Sie auf präzise Montage und korrekte Verwendung der Produkte
- Mängel von Fenstern und Türen sofort beseitigen
- Bei Schleif- und Malerarbeiten bitten den Beschlag entfernen
- Platzierung eines Türstoppers bitte gut planen.

Entretien

Tous les articles présentés dans ce catalogue sont soumis à l'usure. A la longue, suivant le maniement ou l'environnement, des traces de rouille peuvent apparaître. Celles-ci ne proviennent pas du matériau en tant que tel, mais se déposent sur la surface.

Pour éviter ce phénomène, le produit doit être régulièrement entretenu avec un chiffon humide; une fois par semaine suffira dans la plupart des cas. Ne pas utiliser des détergents agressifs ou abrasifs.



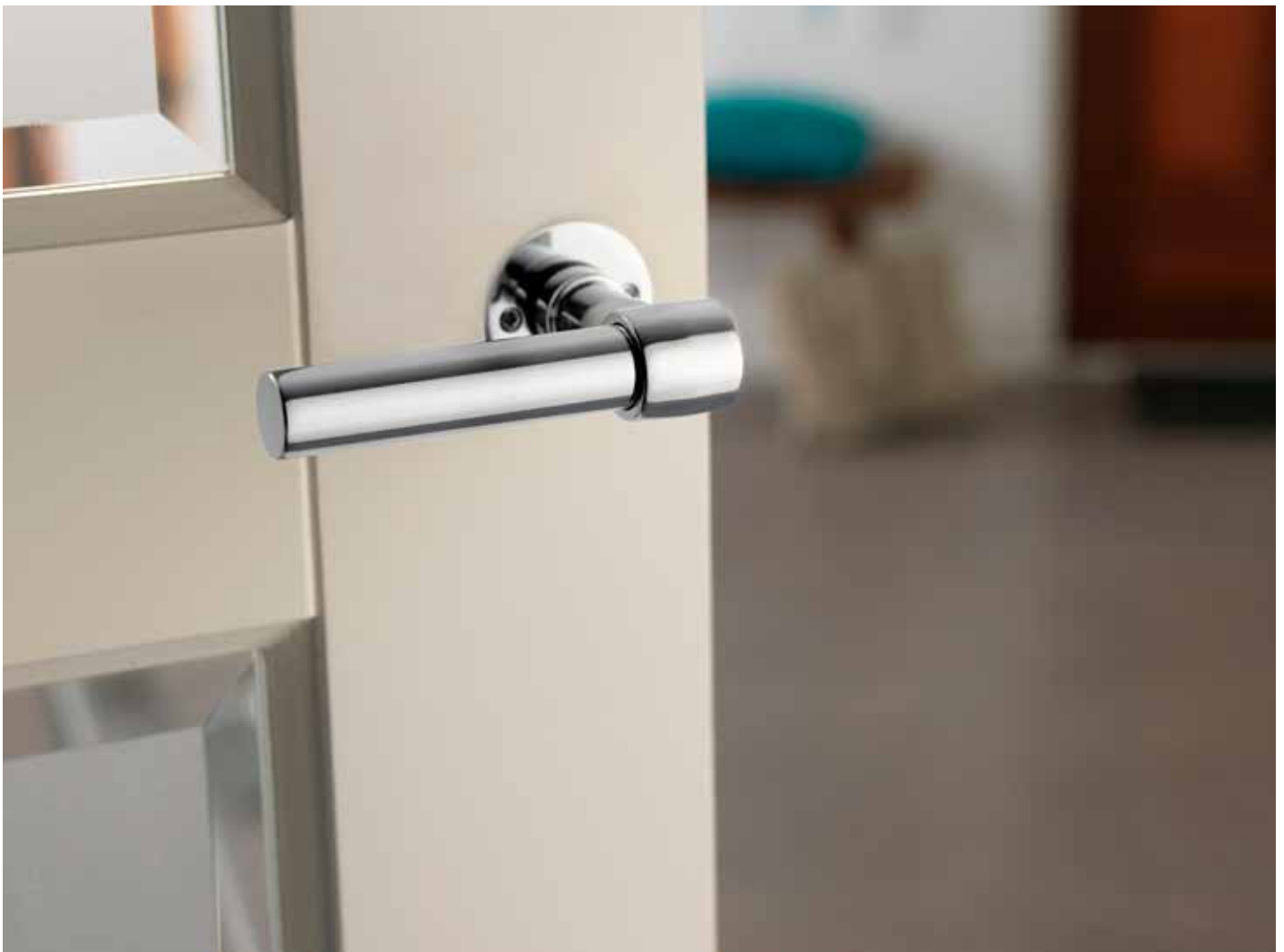



















- Une installation et une utilisation correctes
- En cas de fenêtres ou de portes endommagées (frottement) y remédier au plus vite
- En cas de ponçage ou de peinture, démonter les garnitures complètes
- Prendre des mesures de protection, comme placer des butoirs, par exemple.



Index - artikelgroepen

	.0016	.0018	.0019	.0023
	Chroom Chrome Chrom Chromé	Nikkel Nickel Vernickelt Nicklé	Nikkel mat Satin nickel Nickel matt Nicklé mat	Mat zwart Satin black Matt Schwarz Noir mat
Binnendeurbeslag - Losse krukken en accessoires Interior door hardware - Door handles and accessories Innentürbeschläge - Türdrucker und Zubehör Garnitures de porte intérieure - Béquilles et accessoires	11	113	153	245
Binnendeurbeslag, vastdraaibaar - Rond Interior door hardware, springloaded - Round Innentürbeschläge, Festdrehbar - Rund Garnitures de porte intérieure, avec ressort - Ronde	25	-	165	237
Binnendeurbeslag - Schilden Interior door hardware - Plates Innentürbeschläge - Schilder Garnitures de porte intérieure - Plaqués	19	121	159	250
Binnendeurbeslag, vastdraaibaar - Vierkant Interior door hardware, springloaded - Square Innentürbeschläge, Festdrehbar - Eckig Garnitures de porte intérieure, avec ressort - Carrée	43	125	179	241
Buitendeurbeslag - Rond / Ovaal Exterior door hardware - Round / Oval Türbeschläge - Rund / Oval Garnitures de porte extérieure - Rond / Ovale	49	127	183	251
Buitendeurbeslag - Huiscijfers Exterior door hardware - House numbers Türbeschläge - Hausnummern Garnitures de porte extérieure - Numéros de maison	65	-	191	256
Raambeslag - Raamsluitingen Window fittings - Window closers Fensterbeschläge - Fenstersicherung Garnitures de fenêtre - Béquilles de fenêtre	69	131	201	269
Toebehoren - Sierhulzen Accessories - Hinge covers Zubehör - Übersteckhüls Accessoires - Caches-paumelles	86	-	215	267
Toebehoren - Deurstoppers Accessories - Doorstops Zubehör - Türstopper Accessoires - Butoirs de porte	87	143	217	265
Toebehoren - Schuifdeurbeslag Accessories - Sliding door fittings Zubehör - Schiebetürbeschläge Accessoires - Ferrures de portes coulissantes	89	-	221	268
Toebehoren - Deurgrepen Accessories - Pull handles Zubehör - Stoßgriffe Accessoires - Tirants	91	147	223	-
Toebehoren - Meubelgrepen Accessories - Furniture handles Zubehör - Möbelgriffe Accessoires - Poignées de meuble	95	148	225	273
Toebehoren - Garderobe Accessories - Coat rack Zubehör - Garderoben Accessoires - Porte-manteaux	105	-	219	-
Toebehoren - Leuninghouders Accessories - Handrail holders Zubehör - Handlaufstützen Accessoires - Supports de rampe	109	151	233	279
Toebehoren - Deurspionnen Accessories - Doorviewers Zubehör - Türspionen Accessoires - Judas de porte	111	-	-	-
Toebehoren - Pakket Postkast Accessories - Parcel Locker Zubehör - Postkäste Accessoires - Boîte aux colis	-	-	-	281

Legenda - Index - Legende - Légende

	Compleet paar	Complete pair	Komplett Garnitur	Par paire
	Gatdeel rechts	Single door handle right	Lochteil rechtszeigend	Demi paire droite
	Gatdeel links	Single door handle left	Lochteil linkszeigend	Demi paire gauche
	Knopkruk	Knob handle	Knopf	Bouton fixe
	Blind	Blind	Blind	Aveugle
	Geheel blind	Without holes	Komplett Blind	Complètement aveugle
	Sleutelgat (SL)	Keyhole	Buntbart (BB)	Clé à gorge (BB)
	Profielcilinder (PC)	Profile cylinder	Profilzylinder	Clé à cylindre (PZ)
	Rondcilinder (RC)	Round cylinder	Rundzylinder	Clé à cylindre rond (RC)
	WC-sluiting met venster	Privacy with window	Bad/WC	Fermeture WC avec fenêtre
	WC-sluiting zonder venster	Privacy without window	Bad/WC ohne Fenster	Fermeture WC sans fenêtre
	Bevestigingsmateriaal	Fixing materials	Befestigungsmaterial	Fixations
	Vast draaibaar enkel geveerd	Fixed single rotatable	Festdrehbar	Sertie sur rosace avec ressort
	Vast draaibaar dubbel geveerd	Fixed double rotatable	Doppel gefedert	Sertie sur rosace avec double ressorts
	Deurdikte	Door thickness	Türstärke	Épaisseur de porte
	EN1906 klasse 3	EN1906 class 3	EN1906 Klasse 3	EN 1906 classe 3
	EN1906 klasse 4	EN1906 class 4	EN1906 Klasse 4	EN 1906 classe 4
	SKG ***	SKG ***	SKG ***	SKG ***
	SKG*	SKG*	SKG*	SKG*
	Politie Keurmerk Veilig Wonen	Approval by police	Polizei Geprüft	Approbation par la Police
	Roestvast staal in AISI 304	Stainless Steel 304	Edelstahl 304	Inox AISI 304
	Roestvast staal in AISI 316	Stainless Steel 316	Edelstahl 316	Inox AISI 316
	Functionaliteits garantie	Operational guarantee	Garantie auf die Funktion	Garantie de fonctionnalité



Chroom - Chrome - Chrom - Chromé

Binnendeurbeslag - Losse krukken

0016

Interior door hardware - Door handles

Innentürbeschläge - Türdrucker

Garnitures de porte intérieure - Béquilles

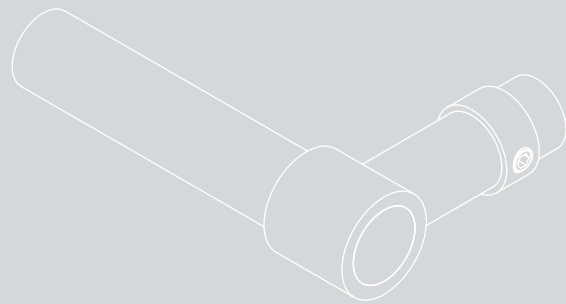

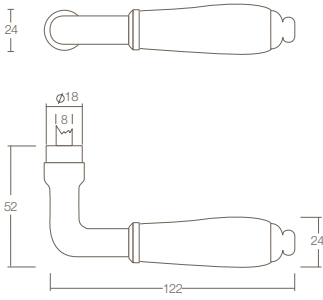

0016.020600

0016.020600A

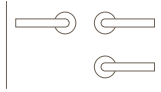

0206

0016.020600

Deurkruk Courgette. Chromo/zwart.



Door handle Courgette. Chrome/black.



Türdrücker Courgette. Chrom/Schwarz.

Béquille Courgette. Chromé/noir.

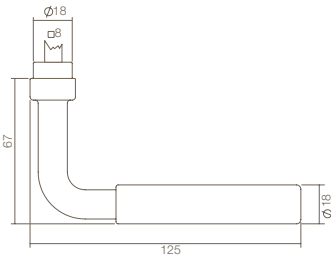

0016.021500

0016.021500A

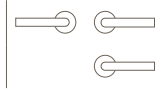

0215

0016.021500

Deurkruk Palma. Chromo.



Door handle Palma. Chrome.



Türdrücker Palma. Chrom.

Béquille Palma. Chromé.

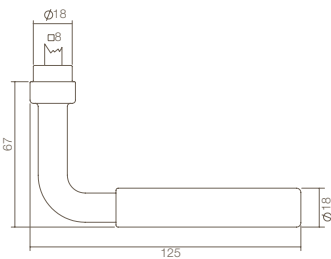

0016.021600

0016.021600A

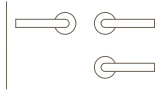

0216

0016.021600

Deurkruk Palma. Chromo/zwart.



Door handle Palma. Chrome/black.



Türdrücker Palma. Chrom/Schwarz.

Béquille Palma. Chromé/noir.

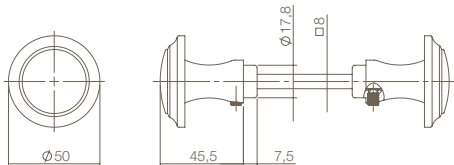

0016.025400

0016.025400A

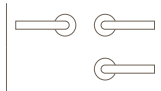

0254

0016.025400

Knopkruk 50mm. Chromo.



Door handle knob 50mm. Chrome.



Türdrücker Knopf 50mm. Chrom.

Béquille bouton 50mm. Chromé.

Accessoires
Accessories
Zubehör



0016.315604



0016.315616



0016.315617



0016.315619

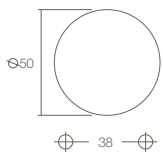

0016.315660



8mm



0016.318004



0016.370960



8mm



0016.253811



0016.253011

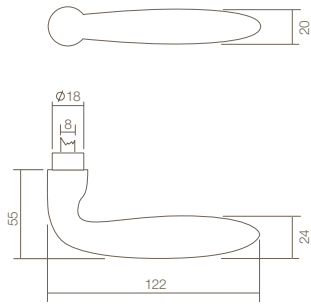

0016.019900

0016.019900A

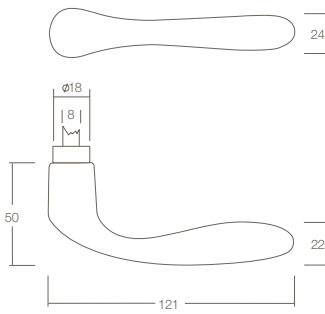
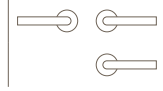

0016.020100

0016.020100A

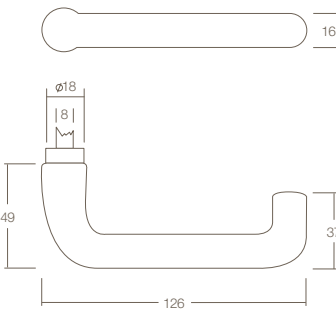
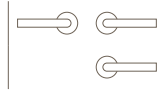

0016.023400

0016.023400A

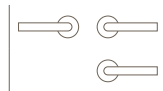

0199

0016.019900

Deurkruk Sigaar. Chromom.

Door handle cigar. Chrome.

Türdrücker Zigarre. Chrom.

Béquille cigare. Chromé.



0201

0016.020100

Deurkruk Banaan. Chromom.

Door handle Banana. Chrome.

Türdrücker Banane. Chrom.

Béquille Banane. Chromé.



0234

0016.023400

Deurkruk Rond. Chromom.

Door handle Round. Chrome.

Türdrücker Rund. Chrom.

Béquille modèle U. Chromé.



Accessoires Accessories Zubehör

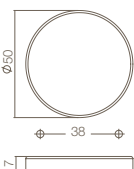

0016.318604



0016.318616



0016.318617



0016.318657

0016.318660

5mm 
8mm 0016.370557
0016.370558
0016.370560
0016.3706605mm 
6mm 
8mm 
8mm  verlengd

0016.253811



0016.253011

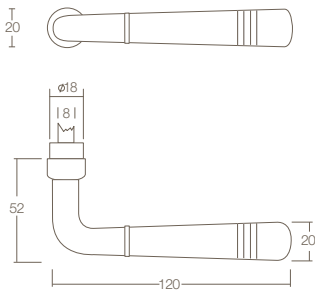

0016.021300
0016.021300A

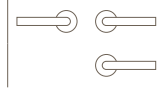

0213

0016.021300 Deurkruk Monique. Chroom.
Door handle Monique. Chrome.
Türdrücker Monique. Chrom.
Béquille Monique. Chromé.

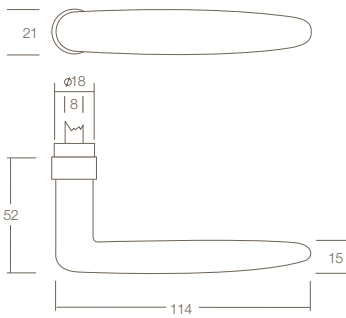

0016.022500
0016.022500A

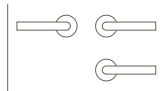

0225

0016.022500 Deurkruk Sophie. Chroom.
Door handle Sophie. Chrome.
Türdrücker Sophie. Chrom.
Béquille Sophie. Chromé.

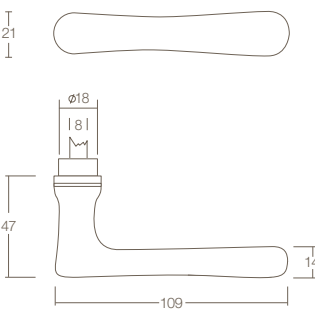

0016.038800
0016.038800A

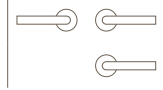

0388

0016.038800 Deurkruk Trento. Chroom.
Door handle Trento. Chrome.
Türdrücker Trento. Chrom.
Béquille Trento. Chromé.



Accessoires
Accessories
Zubehör



0016.317304



0016.317316



0016.317317



0016.317360



8mm



0016.370557
0016.370558
0016.370560
0016.370660



5mm

6mm

8mm

8mm verlengd

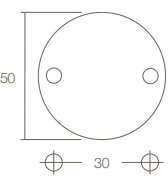

0016.322004



0016.253811



0016.253011

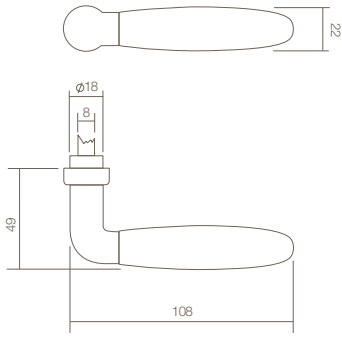

0016.022200

0016.022200A

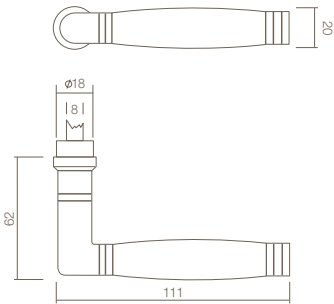
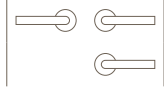

0016.037500

0016.037500A

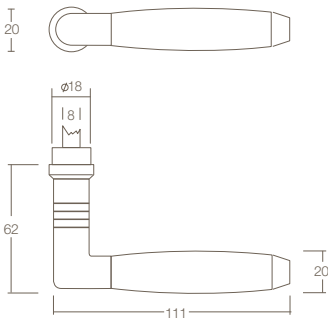
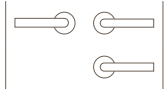

0016.037700

0016.037700A

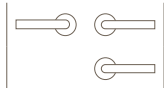

0222

0016.022200

Deurkruk Tessa. Chrom/zwart hout.

Door handle Tessa. Chrome/black wood.

Türdrücker Tessa. Chrom/Schwarzes Holz.

Béquille Tessa. Chromé/bois noir.



0375

0016.037500

Deurkruk Ton 222. Chrom/ebbenhout.

Door handle Ton 222. Chrome/ebony.

Türdrücker Ton 222. Chrom/Ebenholz.

Béquille Ton 222. Chromé/bois d'ébène.



0377

0016.037700

Deurkruk Ton 400. Chrom/ebbenhout.

Door handle Ton 400. Chrome/ebony.

Türdrücker Ton 400. Chrom/Ebenholz.

Béquille Ton 400. Chromé/bois d'ébène.



Accessoires
Accessories
Zubehör

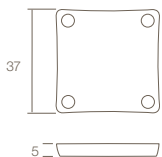

0016.318304



0016.318316



0016.318317



0016.318360 | 8mm



0016.371059
0016.371060

7mm
8mm



0016.322004



0099.370000



0016.370001



0016.253811



0016.253011

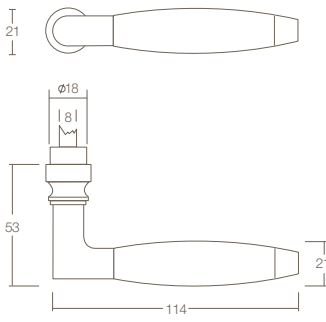

0016.037100

0016.037100A

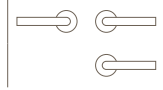

0371

0016.037100

Deurkruk Marloes. Chroom/ebbenhout.

Door handle Marloes. Chrome/ebony.

Türdrücker Marloes. Chrom/Ebenholz.

Béquille Marloes. Chromé/bois d'ébène.



0016.042000

0016.042000A

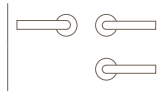

0420

0016.042000

Deurkruk Antonnet. Chroom/ebbenhout.

Door handle Antonnet. Chrome/ebony.

Türdrücker Antonnet. Chrom/Ebenholz.

Béquille Antonnet. Chromé/bois d'ébène.

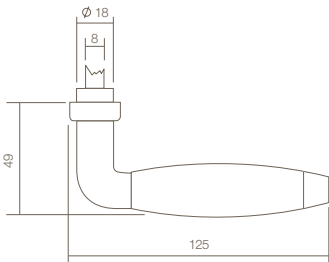

Accessoires
Accessories
Zubehör

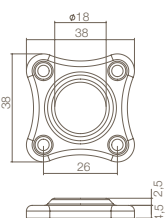

0016.318904



0016.318916



0016.318960 8mm



0016.322004



0016.370557

0016.370560

0016.370660



5mm

8mm

8mm verlengd



0016.253811



0016.253011

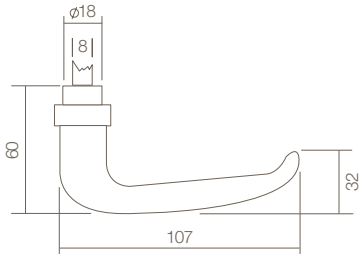

0016.024300

0016.024300A

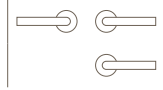

0243

0016.024300

Deurkruk Sabel. Chrom.

Door handle Sabel. Chrome.

Türdrücker Sabel. Chrom.

Béquille Sabre. Chromé.

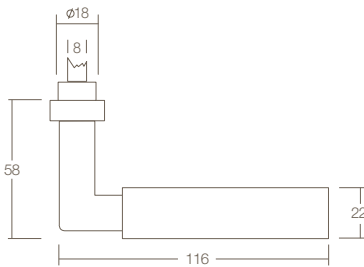

0016.037800

0016.037800A

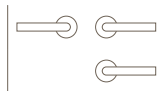

0378

0016.037800

Deurkruk Bau-stil. Chrom.

Door handle Bau-stil. Chrome.

Türdrücker Bau-stil. Chrom.

Béquille Bau-stil. Chromé.

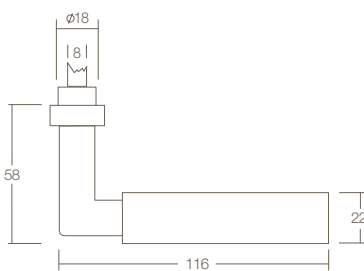

0016.037900

0016.037900A

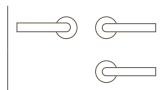

0379

0016.037900

Deurkruk Bau-stil. Chrom/mat zwart.

Door handle Bau-stil. Chrome/Satin black.

Türdrücker Bau-stil. Chrom/Matt Schwarz.

Béquille Bau-stil. Chromé/noir mat.



Accessoires
Accessories
Zubehör

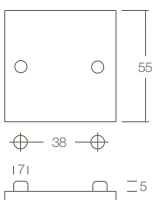

0016.318404



0016.318416



0016.318417



0016.318460



8mm



0016.370557
0016.370560
0016.370660

5mm
8mm
8mm verlengd



0016.253811



0016.253011

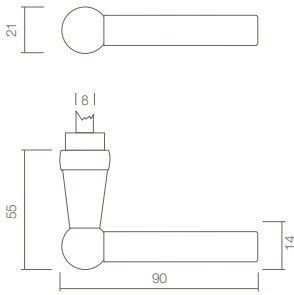

0016.032300



L+L

0016.032300A



L



0323

0016.032300 Deurkruk L/L-model. Chrom.

Door handle L/L. Chrome.

Türdrücker L/L. Chrom.

Béquille modèle L/L. Chromé.

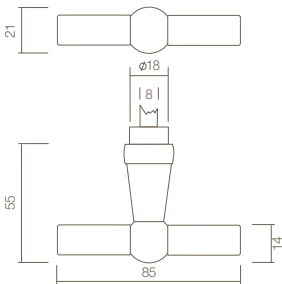

0016.032400



L+T

0016.032400A



T



0324

0016.032400 Deurkruk L/T-model. Chrom.

Door handle L/T. Chrome.

Türdrücker L/T. Chrom.

Béquille modèle L/T. Chromé.

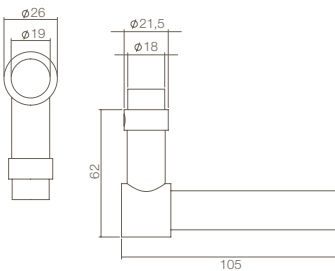

0016.046000



L+L

0016.046000A



L



0460

0016.046000 Deurkruk L/L-model. rech. Chrom.

Door handle L/L. Chrome.

Türdrücker L/L. Chrom.

Béquille modèle L/L. Chromé.

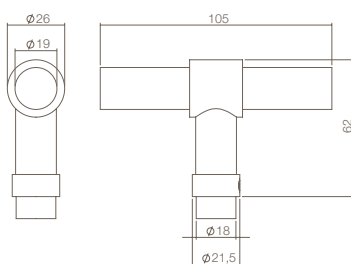

0016.046100



L+T

0016.046100A



T



0461

0016.046100 Deurkruk L/T-model. rech. Chrom.

Door handle L/T. Chrome.

Türdrücker L/T. Chrom.

Béquille modèle L/T. Chromé.



Accessoires

Accessories
Zubehör

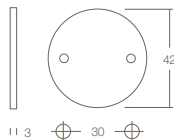

11 3



0016.318504



0016.318516



0016.318517



0016.318560



8mm



0016.370557

0016.370560

0016.370660



5mm

8mm

8mm verlengd



0016.253811



0016.253011

Raamkrukken zie pagina 72-75

Window handles on page 72-75

Fenstergriffe auf Seite 72-75

Béquilles de fenêtre sur page 72-75

Chroom - Chrome - Chrom - Chromé

Binnendeurbeslag - Schilden

0016

Interior door hardware - Plates
Innentürbeschläge - Schilder
Garnitures de porte intérieure - Plaqués



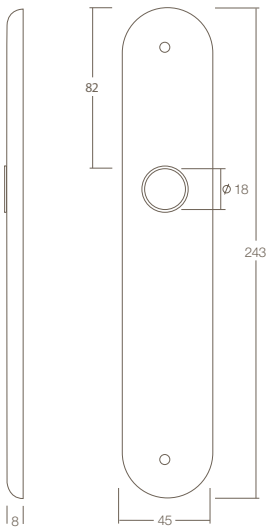

0016.253811				
0016.253824				56mm
0016.253826				72mm
0016.253828				110mm
0016.253829				55mm
0016.253836				72mm
0016.253849				92mm
0016.253854				110mm
0016.253862				WC 55/8
0016.253863				WC 57/5
0016.253865				WC 63/8
0016.253867				WC 72/8

- Optie:** Te combineren met deurkrukken op pagina 12 - 18.
- Option:** Combine with leverhandles from page 12 - 18.
- Option:** Zu kombinieren mit Türdrücker auf Seite 12 - 18.
- Option:** Une combinaison possible avec les béquilles de la page 12 - 18.



0016.253811

Langschild breed ovaal. Chromo.



Long plate. Wide oval. Chrome.



Langschild. Breit oval. Chrom.



Plaque large arrondie. Chromé.

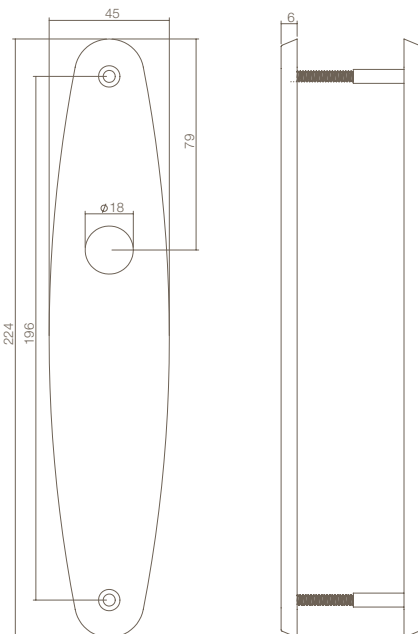

0016.258011				
0016.258024				56mm
0016.258026				72mm
0016.258029				55mm
0016.258036				72mm
0016.258063				WC 57/5
0016.258065				WC 63/8
0016.258067				WC 72/8

- Optie:** Te combineren met deurkrukken op pagina 12 - 18.
- Option:** Combine with leverhandles from page 12 - 18.
- Option:** Zu kombinieren mit Türdrücker auf Seite 12 - 18.
- Option:** Une combinaison possible avec les béquilles de la page 12 - 18.



0016.258011

Langschild. Ellips. Chromo.



Long plate. Ellipse Chrome.



Langschild. Ellipse. Chrom.



Plaque large. Ellipse. Chromé.

2538

2580

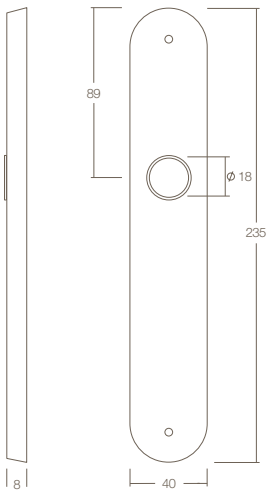

0016.253011			-----	
0016.253024				56mm
0016.253026				72mm
0016.253029				55mm
0016.253036				72mm
0016.253042				85mm
0016.253049				92mm
0016.253055				73.5mm
0016.253062				WC 55/8
0016.253063				WC 57/5
0016.253065				WC 63/8
0016.253067				WC 72/8
0016.253069				WC 78/8

Optie: Te combineren met deurkrukken op pagina 12 - 18.

Option: Combine with leverhandles from page 12 - 18.

Option: Zu kombinieren mit Türdrücker auf Seite 12 - 18.

Option: Une combinaison possible avec les béquilles de la page 12 - 18.



0016.253011

Langschild ovaal. Chromom.



Long plate oval. Chrome.



Langschild oval. Chrom.



Plaque longue ovale. Chromé.

2530

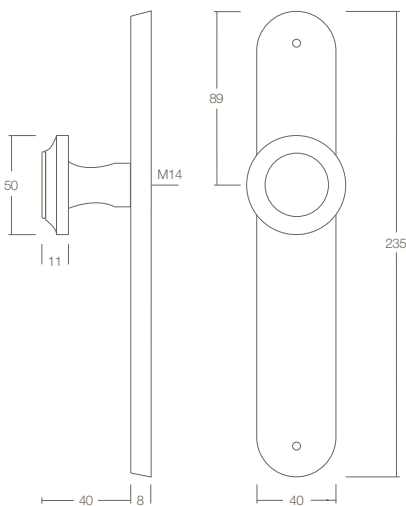

0016.253511		-----	
0016.253524			56mm
0016.253526			72mm
0016.253529			55mm
0016.253536			72mm
0016.253542			85mm

Optie: Te combineren met deurkrukken op pagina 12 - 18.

Option: Combine with leverhandles from page 12 - 18.

Option: Zu kombinieren mit Türdrücker auf Seite 12 - 18.

Option: Une combinaison possible avec les béquilles de la page 12 - 18.



0016.253511

Knoplangschild ovaal. Chromom.



Knob on long plate oval. Chrome.



Knopf Langschild oval. Chrom.

Bouton fixe sur plaque longue arrondie. Chromé.

2535









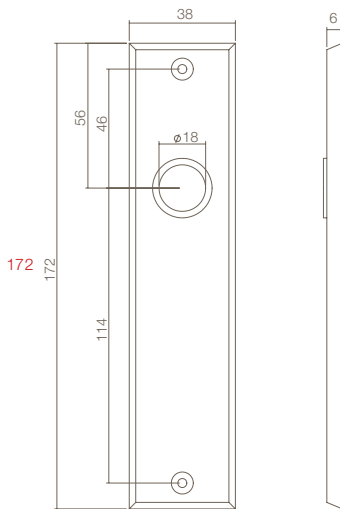

















Accessoires

Accessories
Zubehör



0099.975343	M14			□ 8x70mm	≤ 42
0099.975363	M14			□ 8x90mm	≤ 60
0099.975364	M14			□ 8x120mm	≤ 90



0016.256611				
0016.256624				56mm
0016.256626				72mm
0016.256629				55mm
0016.256636				72mm
0016.256662				WC 55/8
0016.256663				WC 57/5
0016.256665				WC 63/8
0016.256667				WC 72/8

Optie: Te combineren met deurkrukken op pagina 12 - 18.

Option: Combine with leverhandles from page 12 - 18.

Option: Zu kombinieren mit Türdrücker auf Seite 12 - 18.

Option: Une combinaison possible avec les béquilles de la page 12 - 18.



2566

0016.256611

Kortschild rechthoekig, afgeschuind. Chroom.











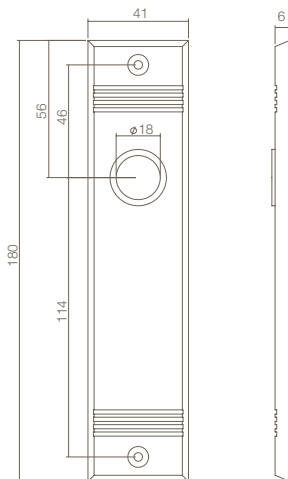



















Short plate. Chamfered. Chrome.



Kurtschild eckig. Gefast. Chrom.

Plaque courte rectangulaire chanfreiné. Chromé.



0016.257011				
0016.257024				56mm
0016.257026				72mm
0016.257029				55mm
0016.257036				72mm
0016.257062				WC 55/8
0016.257063				WC 57/5
0016.257065				WC 63/8
0016.257067				WC 72/8

Optie: Te combineren met deurkrukken op pagina 12 - 18.

Option: Combine with leverhandles from page 12 - 18.

Option: Zu kombinieren mit Türdrücker auf Seite 12 - 18.

Option: Une combinaison possible avec les béquilles de la page 12 - 18.



2570

0016.257011

Kortschild met groef. Chroom.











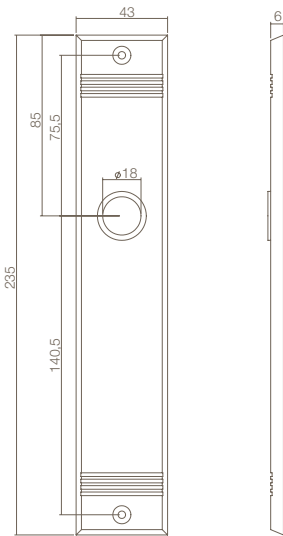





















Short plate straight with chamfer. Chrome.



Kurtschild mit Furche. Chrom.

Plaque courte rectangulaire avec rainures. Chromé.



0016.257111				
0016.257124				56mm
0016.257126				72mm
0016.257129				55mm
0016.257136				72mm
0016.257142				85mm
0016.257149				92mm
0016.257163				WC 57/5
0016.257165				WC 63/8
0016.257167				WC 72/8

- Optie:** Te combineren met deurkrukken op pagina 12 - 18.
- Option:** Combine with doorhandles from page 12 - 18.
- Option:** Zu kombinieren mit Türdrücker auf Seite 12 - 18.
- Option:** Une combinaison possible avec les béquilles de la page 12 - 18.



0016.257111

Langschild rechthoekig met groef. Chrom.



Long plate straight with chamfer. Chrome.











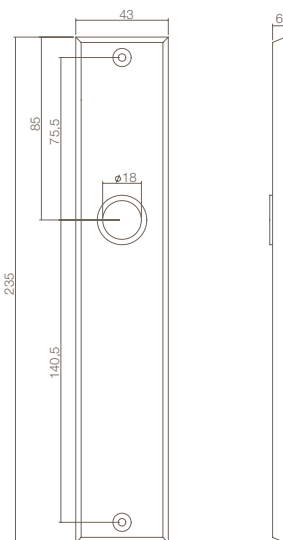





















Langschild eckig. Mit Furche. Chrom.



Plaque longue rectangulaire avec rainure. Chromé.

2571



0016.257711				
0016.257724				56mm
0016.257726				72mm
0016.257729				55mm
0016.257736				72mm
0016.257749				92mm
0016.257762				WC 55/8
0016.257763				WC 57/5
0016.257765				WC 63/8
0016.257767				WC 72/8

- Optie:** Te combineren met deurkrukken op pagina 12 - 18.
- Option:** Combine with doorhandles from page 12 - 18.
- Option:** Zu kombinieren mit Türdrücker auf Seite 12 - 18.
- Option:** Une combinaison possible avec les béquilles de la page 12 - 18.



0016.257711

Renovatie langschild rechthoekig voor krukken met krukhalshals ø18mm. Chrom. 235mm x 43mm x 6mm.



Renovationplate. For door handles with insert ø18mm. Chrome. 235mm x 43mm x 6mm.



Renovationslangschild eckig. Für Türdrücker mit Drücker Hals ø18mm. Chrom. 235mm x 43mm x 6mm.



Plaque de renovation longue rectangulaire. 235mm x 43mm x 6mm. Pour l'usage des béquilles avec cou de ø18mm. Chromé.

2577



Chroom - Chrome - Chrom - Chromé

Binnendeurbeslag, vastdraaibaar - Rond

0016

Interior door hardware, springloaded - Round

Innentürbeschläge, Festdrehbar - Rund

Garnitures de porte intérieure, avec ressort - Ronde

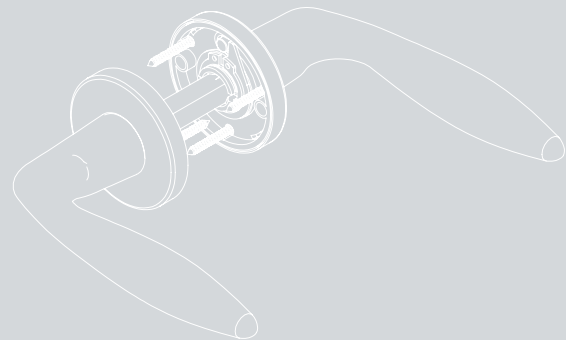

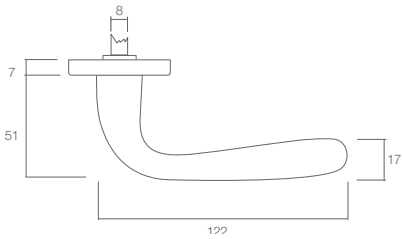
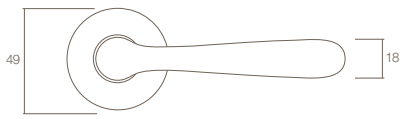

0016.019502

0016.019502A

0016.019502B

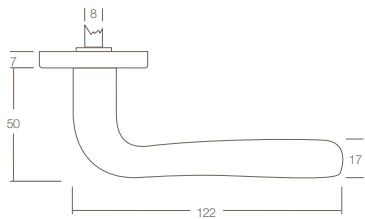
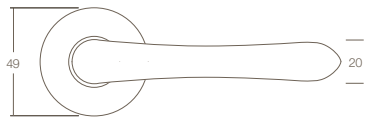
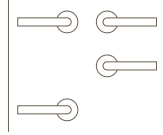

0016.019802

0016.019802A

0016.019802B

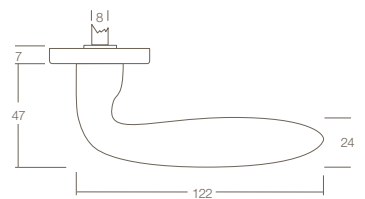
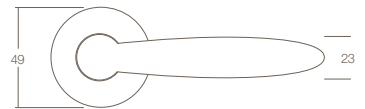
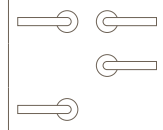

0016.019902

0016.019902A

0016.019902B

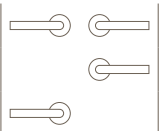

0195

0016.019502

Deurkruk Jupiter vastdraaibaar met veer op ronde rozet. Chrom.



Springloaded door handle Jupiter on round rose. Chrome.



Türdrücker Jupiter festdrehbar gelagert mit Feder auf runder Rosette. Chrom.



Béquille Jupiter sertie sur rosace ronde avec ressort. Chromé.



0198

0016.019802

Deurkruk Saturnus vastdraaibaar met veer op ronde rozet. Chrom.



Springloaded door handle Saturnus on round rose. Chrome.



Türdrücker Saturnus festdrehbar gelagert mit Feder auf runder Rosette. Chrom.



Béquille Saturnus sertie sur rosace ronde avec ressort. Chromé.



0199

0016.019902

Deurkruk Sigara vastdraaibaar met veer op ronde rozet. Chrom.



Springloaded door handle cigar on round rose. Chrome.



Türdrücker Zigarre festdrehbar gelagert mit Feder auf runder Rosette. Chrom.



Béquille Sigare sertie sur rosace ronde avec ressort. Chromé.

Accessoires

Accessories

Zubehör

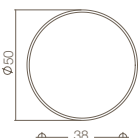

Raamkrukken zie pagina 70-74
Window handles on page 70-74
Fenstergriffe auf seite 70-74
Béquilles de fenêtr sur page 70-74



0016.318616



0016.318617



0016.318660

0016.318657

5mm 
8mm 

0016.370557

0016.370560

0016.370660

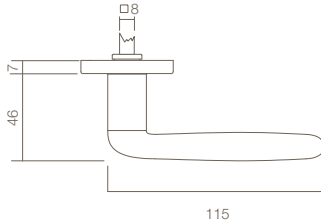
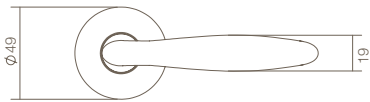

5mm 8mm 8mm  verlengd



0016.020002

0016.020002A

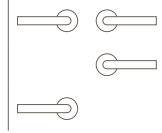
0016.020002B



0200

0016.020002

Deurkruk Phobos vastdraaibaar met veer op ronde rozet. Chromom.



Springloaded door handle Phobos on round rose. Chrome.



Türdrücker Phobos festdrehbar gelagert mit Feder auf runder Rosette. Chrom.



Béquille Phobos sertie sur rosace ronde avec ressort. Chromé.



0231

0016.023102

Deurkruk Elena vastdraaibaar met veer op ronde rozet. Chromom.



Springloaded door handle Elena on round rose. Chrome.



Türdrücker Elena festdrehbar gelagert mit Feder auf runder Rosette. Chrom.



Béquille Elena sertie sur rosace ronde avec ressort. Chromé.



0284

0016.028402

Deurkruk Mare vastdraaibaar met veer op ronde rozet. Chromom.



Springloaded door handle Mare on round rose. Chrome.



Türdrücker Mare festdrehbar gelagert mit Feder auf runder Rosette. Chrom.



Béquille Mare sertie sur rosace ronde avec ressort. Chromé.

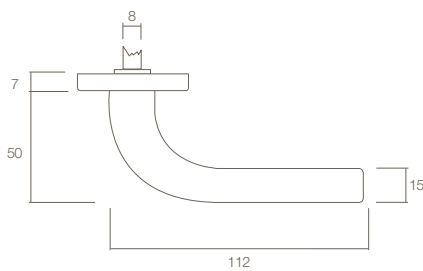
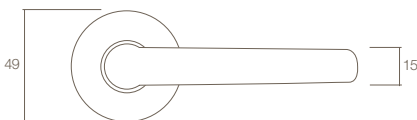

0016.023102

0016.023102A

0016.023102B

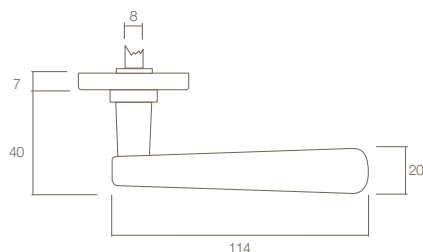
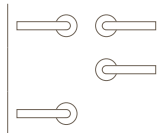

0016.028402

0016.028402A

0016.028402B

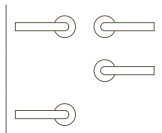

Accessoires

Accessories
Zubehör

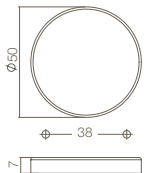

Raamkrukken zie pagina 70-74
Window handles on page 70-74
Fenstergriffe auf seite 70-74
Béquilles de fenêtrre sur page 70-74



0016.318616



0016.318617



0016.318660

5mm

0016.318657

8mm



0016.370557

5mm

0016.370560

8mm

0016.370660

8mm verlengd



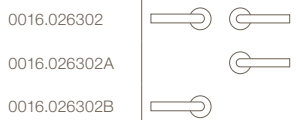
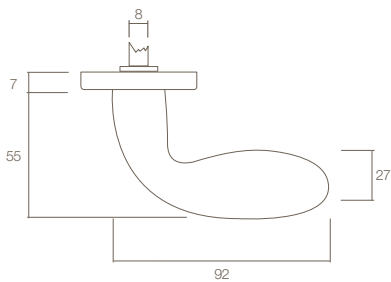
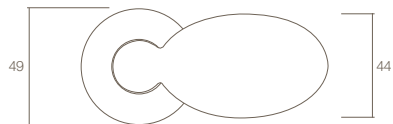
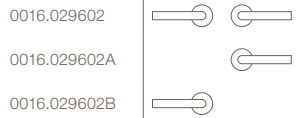
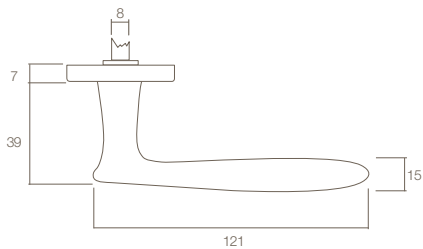

0296

0016.029602 Deurkruk Natalia vastdraaibaar met veer op ronde rozet. Chroom.



Springloaded door handle Natalia on round rose. Chrome.



Türdrücker Natalia festdrehbar gelagert mit Feder auf runder Rosette. Chrom.



Béquille Natalia sertie sur rosace ronde avec ressort. Chromé.



0263

0016.026302 Knopkruk Druppel vastdraaibaar met veer op ronde rozet. Chroom.



Springloaded door handle Drop on round rose. Chrome.



Türdrücker Tropf festdrehbar gelagert mit Feder auf runder Rosette. Chrom.



Béquille Bouton sertie sur rosace ronde, avec ressort. Chromé.

Accessoires

Accessories
Zubehör

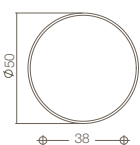



Raamkrukken zie pagina 70-74
Window handles on page 70-74
Fenstergriffe auf seite 70-74
Béquilles de fenêtre sur page 70-74



0016.318616



0016.318617

0016.318660 5mm 0016.318657 8mm 0016.370557 5mm 0016.370560 8mm 0016.370660 8mm  verlengd

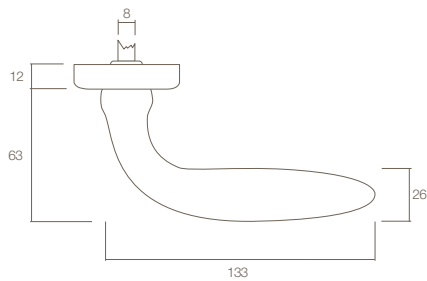
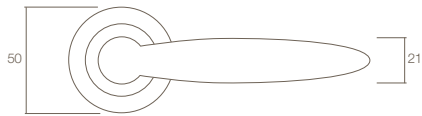

0016.020302

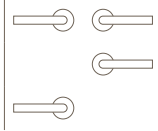

0016.020302A

0016.020302B



0203

0016.020302

Deurkruk Kuba vastdraaibaar met veer op ronde rozet. Chroom.



Springloaded door handle Kuba on round rose. Chrome.



Türdrücker Kuba festdrehbar gelagert mit Feder auf runder Rosette. Chrom.



Béquille Kuba sertie sur rosace ronde, avec ressort. Chromé.

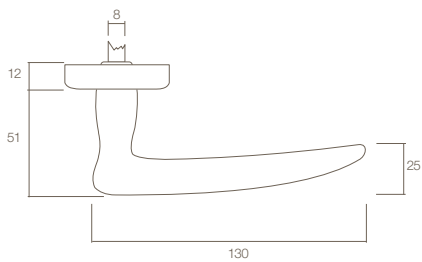

0016.030802

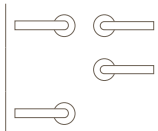

0016.030802A

0016.030802B



0308

0016.030802

Deurkruk Pin up vastdraaibaar met veer op ronde rozet. Chroom.



Springloaded door handle Pin up on round rose. Chrome.



Türdrücker Pin up festdrehbar gelagert mit Feder auf runder Rosette. Chrom.



Béquille Pin up sertie sur rosace ronde, avec ressort. Chromé.

Accessoires

Accessories
Zubehör

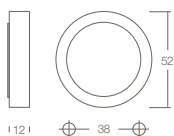

Raamkrukken zie pagina 70-74
Window handles on page 70-74
Fenstergriffe auf seite 70-74
Béquilles de fenêtrre sur page 70-74



0016.316416



0016.316417



0016.316460



0016.370557

5mm

0016.370560

8mm

0016.370660

8mm verlengd



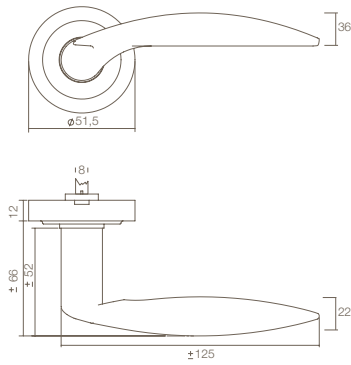

0016.031102



0016.031102A



0016.031102B



0311

**0016.031102**Deurkruk Marsala met verende ronde rozet.
Chroom.Door handle Marsala on springloaded round rose.
Chrome.Türdrücker Marsala mit runder Rosette gelagert
mit feder. Chrom.Béquille Marsala avec rosace ronde,
avec ressort. Chromé.

Accessoires

Accessories
Zubehör

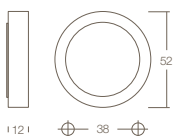

Raamkrukken zie pagina 70-74
Window handles on page 70-74
Fenstergriffe auf seite 70-74
Béquilles de fenêtre sur page 70-74



0016.314716



0016.314717



0016.314104



0016.314760

8mm \varnothing 

0016.370557

5mm \varnothing

0016.370560

8mm \varnothing

0016.370660

8mm \varnothing verlengd

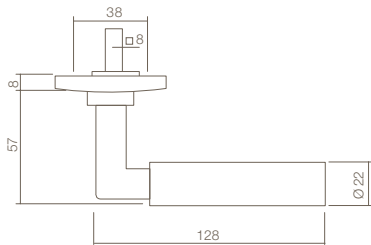
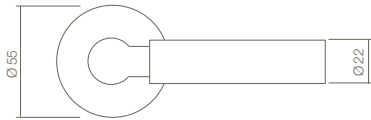

0016.037802

0016.037802A

0016.037802B

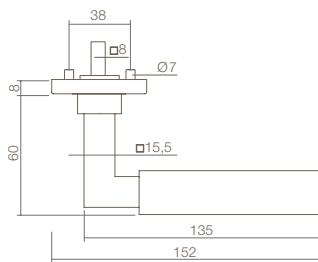
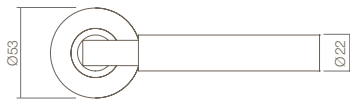
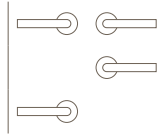

0016.037902

0016.037902A

0016.037902B

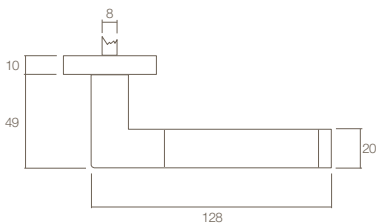
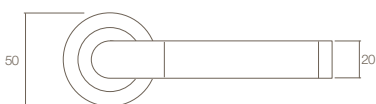
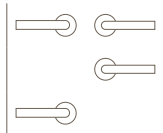

0016.032602

0016.032602A

0016.032602B

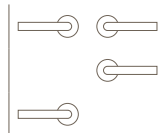

0378

0016.037802

Deurkruk Bau-Stil vastdraaibaar met veer op ronde rozet. Chroom.



Springloaded door handle Bau-Stil on round rose. Chrome.



Türdrücker Bau-Stil festdrehbar gelagert mit Feder auf runder Rosette. Chrom.



Béquille Bau-Stil sertie sur rosace ronde, avec ressort. Chromé.



0379

0016.037902

Deurkruk Bau-Stil vastdraaibaar met veer op ronde rozet. Chroom/mat zwart.



Springloaded door handle Bau-Stil on round rose. Chrome/Satin black.



Türdrücker Bau-Stil festdrehbar gelagert mit Feder auf runder Rosette. Chrom/Matt Schwarz.



Béquille Bau-Stil sertie sur rosace ronde, avec ressort. Chromé/noir mat.



0326

0016.032602

Deurkruk Karina vastdraaibaar met veer op ronde rozet. Chroom/zwart.



Springloaded door handle Karina on round rose. Chrome/black.



Türdrücker Karina festdrehbar gelagert mit Feder auf runder Rosette. Chrom/Schwarz.



Béquille Karina sertie sur rosace ronde, avec ressort. Chromé/noir.

Accessoires

Accessories

Zubehör

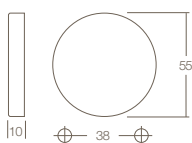

Raamkrukken zie pagina 70-74
Window handles on page 70-74
Fenstergriffe auf seite 70-74
Béquilles de fenêtre sur page 70-74



0016.316316



0016.316317



0016.316360



8mm



0016.317116

0016.317117

0016.317117

0016.317160

0016.317160

0016.317160

0016.317160

0016.317160

0016.317160

0016.317160



0016.370557

5mm

0016.370560

8mm

0016.370660

8mm verlengd



HOME



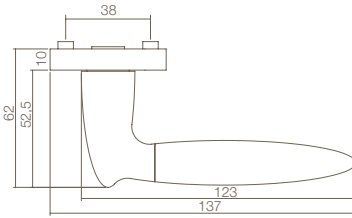
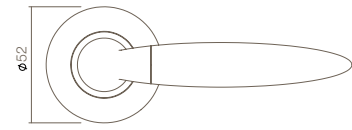

0016.168202				
0016.168202A				
0016.168202B				
0016.168203				
0016.168205				
0016.168210				
0016.168212A				
0016.168212B				



1682

0016.168202

Deurkruk Ellen, vastdraaibaar met veer op ronde rozet. Nokken ø7mm. Chrom/mat nikkel.



Springloaded door handle Ellen on round rose. Lugs ø7mm. Chrome/satin nickel.



Türdrücker Ellen festdrehbar gelagert mit Feder auf runder Rosette. Stütznocken ø7mm. Chrom/Nickel Matt.



Béquille Ellen sertie sur rosace ronde avec ressort. Tenons ø7mm. Chromé/nicklé mat.

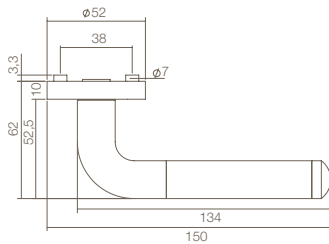
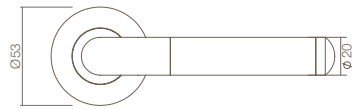

0016.168302				
0016.168302A				
0016.168302B				
0016.168303				
0016.168305				
0016.168310				
0016.168312A				
0016.168312B				



1683

0016.168302

Deurkruk Agatha, vastdraaibaar met veer op ronde rozet. Nokken ø7mm. Chrom/mat nikkel.



Springloaded door handle Agatha on round rose. Lugs ø7mm. Chrome/satin nickel.



Türdrücker Agatha festdrehbar gelagert mit Feder auf runder Rosette. Stütznocken ø7mm. Chrom/Nickel Matt.



Béquille Agatha sertie sur rosace ronde avec ressort. Tenons ø7mm. Chromé/nicklé mat.

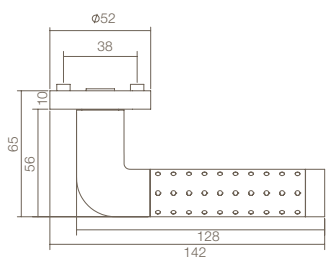
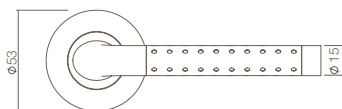

0016.168402				
0016.168402A				
0016.168402B				
0016.168403				
0016.168405				
0016.168410				
0016.168412A				
0016.168412B				



1684

0016.168402

Deurkruk Marion, vastdraaibaar met veer op ronde rozet. Nokken ø7mm. Chrom/mat nikkel.



Springloaded door handle Marion on round rose. Lugs ø7mm. Chrome/satin nickel.



Türdrücker Marion festdrehbar gelagert mit Feder auf runder Rosette. Stütznocken ø7mm. Chrom/Nickel Matt.



Béquille Marion sertie sur rosace ronde avec ressort. Tenons ø7mm. Chromé/nicklé mat.

Accessoires

Accessories
Zubehör

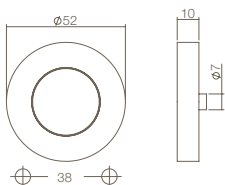

0016.347616



0016.347617



0016.347618



0016.347658

6mm

0016.347659

7mm

0016.347660

8mm

6mm

7mm

8mm



0016.212600

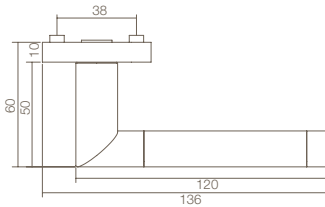
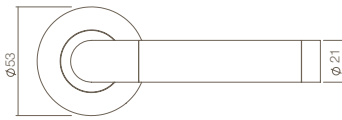

0016.168502				
0016.168502A				
0016.168502B				
0016.168503				
0016.168505				
0016.168510				
0016.168512A				
0016.168512B				

WC 8mm



1685

0016.168502 Deurkruk Nicol, vastdraaibaar met veer op ronde rozet. Nokken ø7mm. Chroom/mat nikkel.



Springloaded door handle Nicol on round rose. Lugs ø7mm. Chrome/satin nickel.



Türdrücker Nicol festdrehbar gelagert mit Feder auf runder Rosette. Stütznocken ø7mm. Chrom/Nickel Matt.



Béquille Nicol sertie sur rosace ronde avec ressort. Tenons ø7mm. Chromé/nicklé mat.

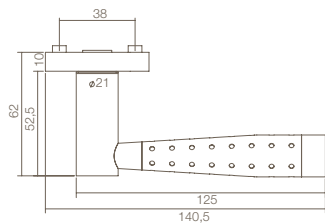
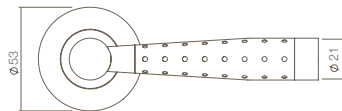

0016.168602				
0016.168602A				
0016.168602B				
0016.168603				
0016.168605				
0016.168610				
0016.168612A				
0016.168612B				

WC 8mm



1686

0016.168602 Deurkruk Viki, vastdraaibaar met veer op ronde rozet. Nokken ø7mm. Chroom/mat nikkel.



Springloaded door handle Viki on round rose. Lugs ø7mm. Chrome/satin nickel.



Türdrücker Viki festdrehbar gelagert mit Feder auf runder Rosette. Stütznocken ø7mm. Chrom/Nickel Matt.



Béquille Viki sertie sur rosace ronde avec ressort. Tenons ø7mm. Chromé/nicklé mat.

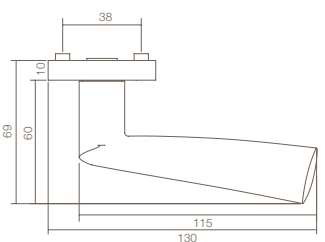
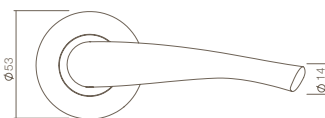

0016.168702				
0016.168702A				
0016.168702B				
0016.168703				
0016.168705				
0016.168708				
0016.168710				
0016.168712A				
0016.168712B				

WC 6mm
WC 8mm



1687

0016.168702 Deurkruk Gussy, vastdraaibaar met veer op ronde rozet. Nokken ø7mm. Chroom/mat nikkel.



Springloaded door handle Gussy on round rose. Lugs ø7mm. Chrome/satin nickel.



Türdrücker Gussy festdrehbar gelagert mit Feder auf runder Rosette. Stütznocken ø7mm. Chrom/Nickel Matt.



Béquille Gussy sertie sur rosace ronde avec ressort. Tenons ø7mm. Chromé/nicklé mat.

Accessoires Accessories Zubehör

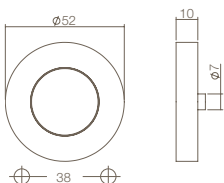

0016.347616



0016.347617



0016.347618



0016.347658

0016.347659

0016.347660



0016.212600



6mm

7mm

8mm

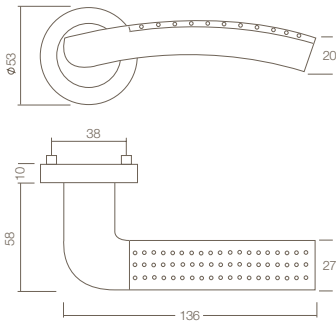

0016.168802					
0016.168802A					
0016.168802B					
0016.168803					
0016.168805					
0016.168810					WC 8mm
0016.168812A					
0016.168812B					



1688

0016.168802

Deurkruk Sharon, vastdraaibaar met veer op ronde rozet. Nokken ø7mm. Chroom/mat nikkel.



Springloaded door handle Sharon on round rose. Lugs ø7mm. Chrome/satin nickel.



Türdrücker Sharon festdrehbar gelagert mit Feder auf runder Rosette. Stütznocken ø7mm. Chrom/Nickel Matt.



Béquille Sharon sertie sur rosace ronde avec ressort. Tenons ø7mm. Chromé/nicklé mat.

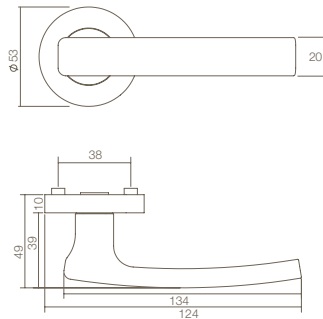

0016.168902					
0016.168902A					
0016.168902B					
0016.168903					
0016.168905					
0016.168910					WC 8mm
0016.168912A					
0016.168912B					



1689

0016.168902

Deurkruk Blok, vastdraaibaar met veer op ronde rozet. Nokken ø7mm. Chroom/mat nikkel.



Springloaded door handle Block on round rose. Lugs ø7mm. Chrome/satin nickel.



Türdrücker Blok festdrehbar gelagert mit Feder auf runder Rosette. Stütznocken ø7mm. Chrom/Nickel Matt.



Béquille modèle Blok sertie sur rosace ronde avec ressort. Tenons ø7mm. Chromé/nicklé mat.

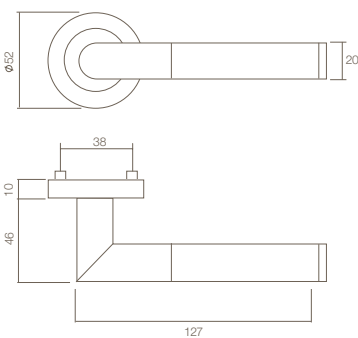

0016.169302					
0016.169302A					
0016.169302B					
0016.169303					
0016.169305					
0016.169310					WC 8mm
0016.169312A					
0016.169312B					



1693

0016.169302

Deurkruk Bastian, vastdraaibaar met veer op ronde rozet. Nokken ø7mm. Chroom/mat nikkel.



Springloaded door handle Bastian on round rose. Lugs ø7mm. Chrome/satin nickel.



Türdrücker Bastian festdrehbar gelagert mit Feder auf runder Rosette. Stütznocken ø7mm. Chrom/Nickel Matt.



Béquille Bastian sertie sur rosace ronde avec ressort. Tenons ø7mm. Chromé/nicklé mat.

Accessoires

Accessories
Zubehör

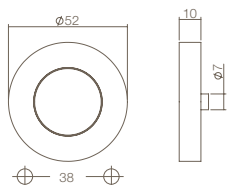

0016.347616



0016.347617



0016.347618



0016.347658



0016.347659



0016.347660



6mm









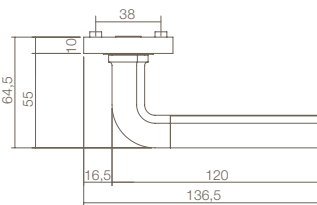
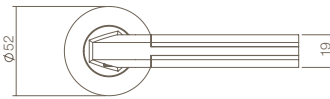
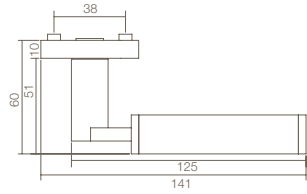
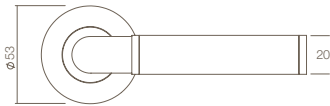















7mm









8mm



0016.212600



0016.169402					
0016.169402A					
0016.169402B					
0016.169403					
0016.169405					
0016.169410					WC 8mm
0016.169412A					
0016.169412B					

0016.171902					
0016.171902A					
0016.171902B					
0016.171903					



1694

0016.169402

Deurkruk Jean, vastdraaibaar met veer op ronde rozet. Nokken ø7mm. Chroom/mat nikkel.



Springloaded door handle Jean on round rose. Lugs ø7mm. Chrome/satin nickel.



Türdrücker Jean festdrehbar gelagert mit Feder auf runder Rosette. Stütznocken ø7mm. Chrom/Nickel Matt.



Béquille Jean sertie sur rosace ronde avec ressort. Tenons ø7mm. Chromé/nicklé mat.



1719

0016.171902

Deurkruk Bas, vastdraaibaar met veer op ronde rozet. Nokken ø7mm. Chroom/mat nikkel.



Springloaded door handle Bas on round rose. Lugs ø7mm. Chrome/satin nickel.



Türdrücker Bas festdrehbar gelagert mit Feder auf runder Rosette. Stütznocken ø7mm. Chrom/Nickel Matt.



Béquille Bas sertie sur rosace ronde avec ressort. Tenons ø7mm. Chromé/nicklé mat.

Accessoires

Accessories
Zubehör

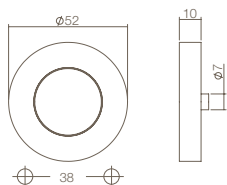

0016.347616



0016.347617



0016.347618



0016.347658



0016.347659



0016.347660

	6mm 
	7mm 
	8mm 



0016.212600

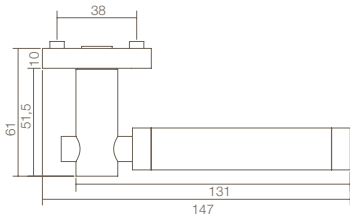
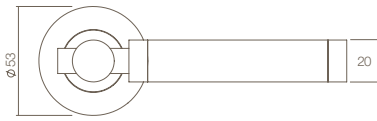

0016.169802				
0016.169802A				
0016.169802B				
0016.169803				
0016.169805				
0016.169808				
0016.169810				

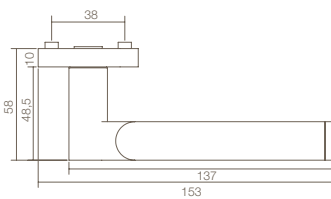
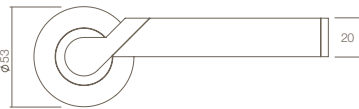

0016.170102				
0016.170102A				
0016.170102B				
0016.170103				
0016.170105				
0016.170108				
0016.170110				
0016.170112A				
0016.170112B				

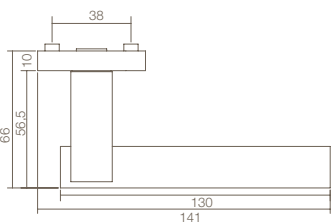
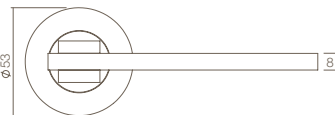

0016.170202				
0016.170202A				
0016.170202B				



1698

0016.169802 Deurkruk Birgit, vastdraaibaar met veer op ronde rozet. Nokken ø7mm. Chrom/mat nikkel.



Springloaded door handle Birgit on round rose. Lugs ø7mm. Chrome/satin nickel.



Türdrücker Birgit festdrehbar gelagert mit Feder auf runder Rosette. Stütznocken ø7mm. Chrom/Nickel Matt.



Béquille Birgit sertie sur rosace ronde avec ressort. Tenons ø7mm. Chromé/nicklé mat.



1701

0016.170102 Deurkruk Casper, vastdraaibaar met veer op ronde rozet. Nokken ø7mm. Chrom/mat nikkel.



Springloaded door handle Casper on round rose. Lugs ø7mm. Chrome/satin nickel.



Türdrücker Casper festdrehbar gelagert mit Feder auf runder Rosette. Stütznocken ø7mm. Chrom/Nickel Matt.



Béquille Casper sertie sur rosace ronde avec ressort. Tenons ø7mm. Chromé/nicklé mat.



1702

0016.170202 Deurkruk Jim, vastdraaibaar met veer op ronde rozet. Nokken ø7mm. Chrom/mat nikkel.



Springloaded door handle Jim on round rose. Lugs ø7mm. Chrome/satin nickel.



Türdrücker Jim festdrehbar gelagert mit Feder auf runder Rosette. Stütznocken ø7mm. Chrom/Nickel Matt.



Béquille Jim sertie sur rosace ronde avec ressort. Tenons ø7mm. Chromé/nicklé mat.

Accessoires Accessories Zubehör

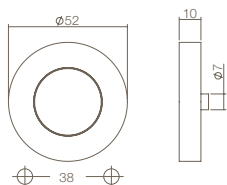

0016.347616



0016.347617



0016.347618



0016.347658



0016.347659

0016.347660



6mm

7mm

8mm



0016.212600

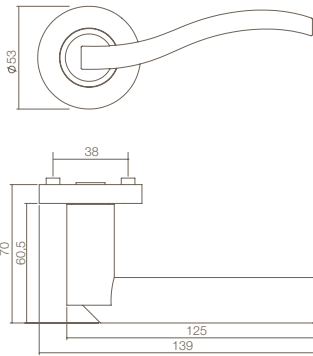

0016.170402					
0016.170402A					
0016.170402B					
0016.170403					
0016.170405					
0016.170410					WC 8mm
0016.170412A					
0016.170412B					

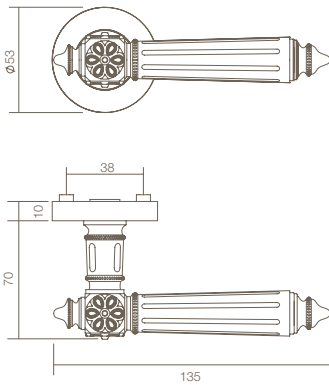

0016.171602					
0016.171602A					
0016.171602B					
0016.171603					
0016.171605					
0016.171610					WC 8mm
0016.171612A					
0016.171612B					

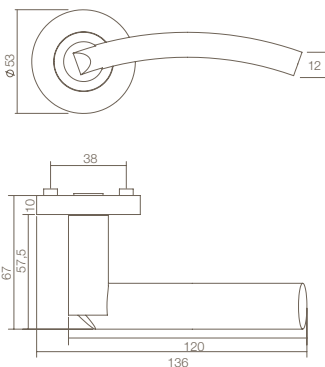

0016.169702					
0016.169702A					
0016.169702B					
0016.169703					
0016.169705					
0016.169710					WC 8mm

1704

**0016.170402**

Deurkruk Silvana, vastdraaibaar met veer op ronde rozet. Nokken ø7mm. Chrom/mat nikkel.



Springloaded door handle Silvana on round rose. Lugs ø7mm. Chrome/satin nickel.



Türdrücker Silvana festdrehbar gelagert mit Feder auf runder Rosette. Stütznocken ø7mm. Chrom/Nickel Matt.



Béquille Silvana sertie sur rosace ronde avec ressort. Tenons ø7mm. Chromé/nicklé mat.

1716

**0016.171602**

Deurkruk Julietta, vastdraaibaar met veer op ronde rozet. Nokken ø7mm. Chrom/mat nikkel.



Springloaded door handle Julietta on round rose. Lugs ø7mm. Chrome/satin nickel.



Türdrücker Julietta festdrehbar gelagert mit Feder auf runder Rosette. Stütznocken ø7mm. Chrom/Nickel Matt.



Béquille Julietta sertie sur rosace ronde avec ressort. Tenons ø7mm. Chromé/nicklé mat.

1697

**0016.169702**

Deurkruk Sylvia, vastdraaibaar met veer op ronde rozet. Nokken ø7mm. Chrom/mat nikkel.



Springloaded door handle Sylvia on round rose. Lugs ø7mm. Chrome/satin nickel.



Türdrücker Sylvia festdrehbar gelagert mit Feder auf runder Rosette. Stütznocken ø7mm. Chrom/Nickel Matt.



Béquille Sylvia sertie sur rosace ronde avec ressort. Tenons ø7mm. Chromé/nicklé mat.

Accessoires

Accessories
Zubehör

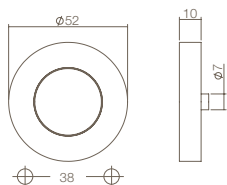

0016.347616



0016.347617



0016.347618



0016.347658

6mm

0016.347659

7mm









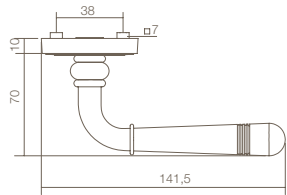
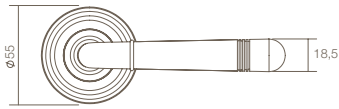







0016.347660

8mm









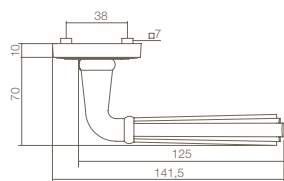
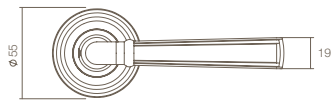









0016.212600



0016.172502					
0016.172502A					
0016.172502B					
0016.172503					
0016.172505					
0016.172510					WC 8mm



0016.173502					
0016.173502A					
0016.173502B					
0016.173503					
0016.173505					
0016.173510					WC 8mm



1725

0016.172502 Deurkruk Emily, vastdraaibaar met veer op ronde rozet. Nokken ø7mm. Chrom.



Springloaded door handle Emily on round rose. Lugs ø7mm. Chrome.



Türdrücker Emily festdrehbar gelagert mit Feder auf runder Rosette. Stütznocken ø7mm. Chrom.



Béquille Emily sertie sur rosace ronde avec ressort. Tenons ø7mm. Chromé.



1735

0016.173502 Deurkruk Bellevue, vastdraaibaar met veer op ronde rozet. Nokken ø7mm. Chrom.



Springloaded door handle Bellevue on round rose. Lugs ø7mm. Chrome.









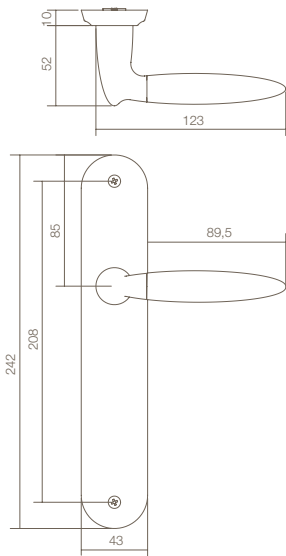















Türdrücker Bellevue festdrehbar gelagert mit Feder auf runder Rosette. Stütznocken ø7mm. Chrom.



Béquille Bellevue sertie sur rosace ronde avec ressort. Tenons ø7mm. Chromé.



0016.168211			-----	
0016.168211A			-----	
0016.168211B			-----	
0016.168224				56mm
0016.168226				72mm
0016.168229				55mm
0016.168236				72mm
0016.168265				WC 63/8
0016.168269				WC 78/8

1682

**0016.168211**

Deurkruk Ellen vastdraaibaar met veer op langschild. Chrom/nikkel mat.



Door handle Ellen on long plate. Chrome/satin nickel.









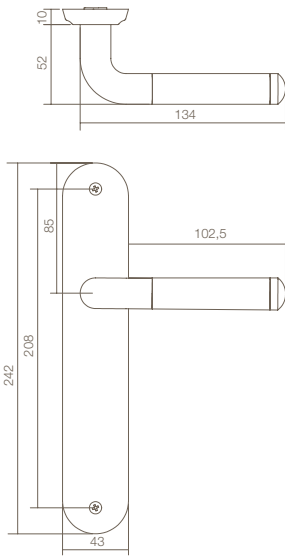



































Türdrücker Ellen auf Langschild. Chrom/Nickel Matt.



Béquille Ellen sertie sur plaque longue avec ressort. Chromé/nicklé mat.



0016.168311			-----	
0016.168311A			-----	
0016.168311B			-----	
0016.168324				56mm
0016.168326				72mm
0016.168329				55mm
0016.168336				72mm
0016.168345				88mm
0016.168365				WC 63/8
0016.168369				WC 78/8
0016.168380				90mm
0016.168383				WC 90/7
0016.168390A				72mm
0016.168390B				72mm
0016.168391A				88mm
0016.168391B				88mm



1683

0016.168311

Deurkruk Agatha vastdraaibaar met veer op langschild. Chrom/nikkel mat.



Round door handle Agatha springloaded on long plate. Chrome/satin nickel.









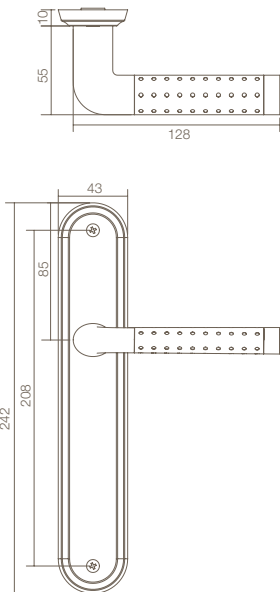











Türdrücker Agatha Festdrehbar mit feder auf Langschild. Chrom/Nickel Matt.



Béquille Agatha sertie sur plaque longue avec ressort. Chromé/nicklé mat.



0016.168411			-----	
0016.168411A			-----	
0016.168411B			-----	
0016.168424				56mm
0016.168426				72mm
0016.168436				72mm
0016.168463				WC 57/5
0016.168469				WC 78/8



1684

0016.168411

Deurkruk Marion vastdraaibaar met veer op langschild. Chrom/nikkel mat.



Door handle Marion springloaded on long plate. Chrome/satin nickel.



Türdrücker Marion Festdrehbar mit feder auf Langschild. Chrom/Nickel Matt.



Béquille Marion sertie sur plaque longue avec ressort. Chromé/nicklé mat.



Chroom - Chrome - Chrom - Chromé

Binnendeurbeslag, vastdraaibaar - Vierkant

0016

Interior door hardware, springloaded - Square

Innentürbeschläge, Festdrehbar - Eckig

Garnitures de porte intérieure, avec ressort - Carrée

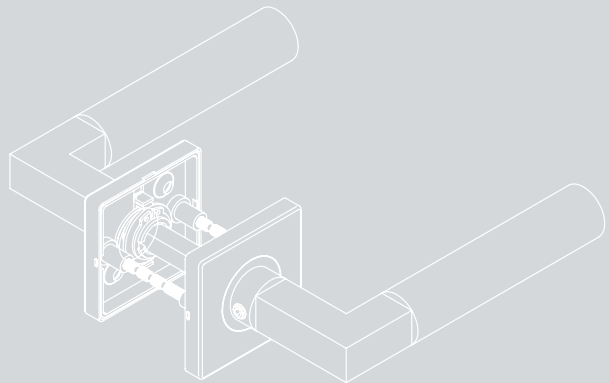

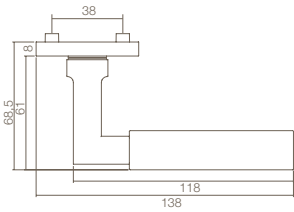
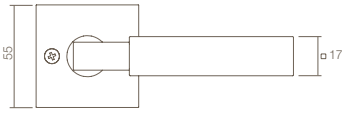

- 0016.038102
- 0016.038102A
- 0016.038102B

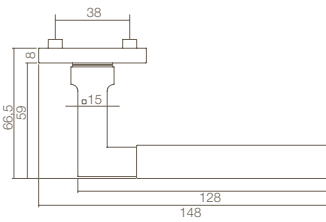
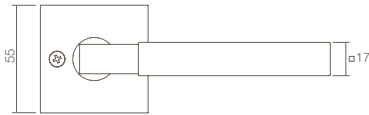

- 0016.038302
- 0016.038302A
- 0016.038302B

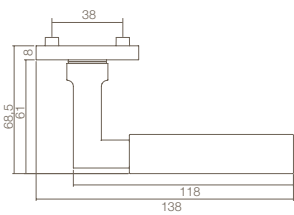
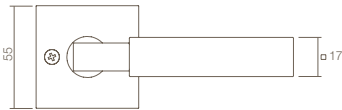

- 0016.038402
- 0016.038402A
- 0016.038402B



0381

0016.038102 Deurkruk Bau-Stil, rond, vastdraaibaar met veer op vierkante rozet. Chroom



Springloaded door handle Bau-Stil, round on square rose. Chrome.



Türdrücker Bau-Stil, Rund festdrehbar gelagert mit Feder auf eckiger Rosette. Chrom.



Béquille Bau-Stil ronde, sertie sur rosace carrée avec ressort. Chromé.



0383

0016.038302 Deurkruk Bau-Stil, vierkant, vastdraaibaar met veer op vierkante rozet. Chroom



Springloaded door handle Bau-Stil, square on square rose. Chrome.



Türdrücker Bau-Stil, Eckig festdrehbar gelagert mit Feder auf eckiger Rosette. Chrom.



Béquille Bau-Stil carrée, sertie sur rosace carrée avec ressort. Chromé.



0384

0016.038402 Deurkruk Bau-Stil, rond, vastdraaibaar met veer op vierkante rozet. Chroom/mat zwart



Springloaded door handle Bau-Stil, round on square rose. Chrome/satin black.



Türdrücker Bau-Stil, Rund festdrehbar gelagert mit Feder auf eckiger Rosette. Chrom/Matt Schwarz.



Béquille Bau-Stil ronde, sertie sur rosace carrée avec ressort. Chromé/noir mat.

Accessoires
Accessories
Zubehör

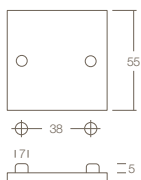

0016.318416



0016.318417



0016.318460



8mm



0016.370960



8mm



0016.370557

0016.370560

0016.370660









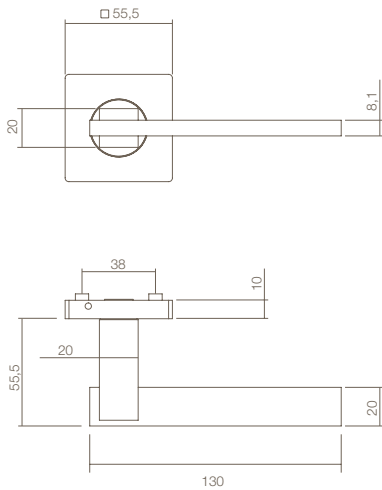



















5mm

8mm

8mm verlengd





0016.171202					
0016.171202A					
0016.171202B					
0016.171203					
0016.171205					
0016.171208					WC 6mm
0016.171210					WC 8mm
0016.171212A					
0016.171212B					



1712

0016.171202

Deurkruk Jim vastdraaibaar met veer op vierkante rozet. Nokken ø7mm. Chrom/mat nikkel.











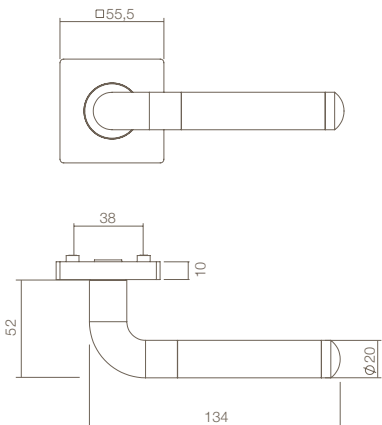













Springloaded door handle Jim on square rose. Lugs ø7mm. Chrome/satin nickel.



Türdrücker Jim festdrehbar gelagert mit Feder auf eckiger Rosette. Stütznocken ø7mm. Chrom/Nickel Matt.

Béquille Jim sertie sur rosace carrée avec ressort. Tenons ø7mm. Chromé/nicklé mat.



0016.171302					
0016.171302A					
0016.171302B					
0016.171303					
0016.171305					
0016.171308					WC 6mm
0016.171310					WC 8mm



1713

0016.171302

Deurkruk Agatha vastdraaibaar met veer op vierkante rozet. Nokken ø7mm. Chrom/mat nikkel.



Springloaded door handle Agatha on square rose. Lugs ø7mm. Chrome/satin nickel.



Türdrücker Agatha festdrehbar gelagert mit Feder auf eckiger Rosette. Stütznocken ø7mm. Chrom/Nickel Matt.

Béquille Agatha sertie sur rosace carrée avec ressort. Tenons ø7mm. Chromé/nicklé mat.

Accessoires

Accessories
Zubehör

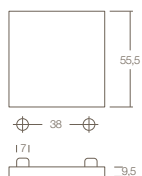

0016.347816



0016.347817



0016.347916



0016.347858



0016.347860



6mm

8mm



0019.212602

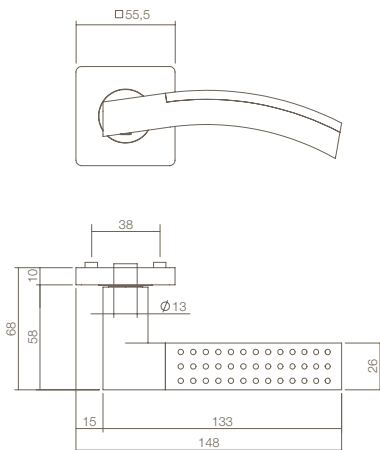

0016.171702



0016.171702A



0016.171702B



1717

0016.171702

Deurkruk Simone vastdraaibaar met veer op vierkante rozet. Nokken $\varnothing 7\text{mm}$. Chrom/mat nikkel.



Springloaded door handle Simone on square rose. Lugs $\varnothing 7\text{mm}$. Chrome/satin nickel.



Türdrücker Simone festdrehbar gelagert mit Feder auf eckiger Rosette. Stütznocken $\varnothing 7\text{mm}$. Chrom/Nickel Matt.

Béquille Simone sertie sur rosace carrée avec ressort. Tenons $\varnothing 7\text{mm}$. Chromé/nicklé mat.

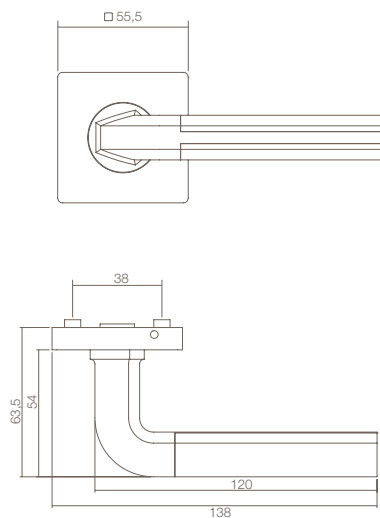

0016.171802



0016.171802A



0016.171802B



1718

0016.171802

Deurkruk Amber, vastdraaibaar met veer op vierkante rozet. Nokken $\varnothing 7\text{mm}$. Chrom/mat nikkel.



Springloaded door handle Amber on square rose. Lugs $\varnothing 7\text{mm}$. Chrome/satin nickel.



Türdrücker Amber festdrehbar gelagert mit Feder auf eckiger Rosette. Stütznocken $\varnothing 7\text{mm}$. Chrom/Nickel Matt.

Béquille Amber sertie sur rosace carrée avec ressort. Tenons $\varnothing 7\text{mm}$. Chromé/nicklé mat.

Accessoires Accessories Zubehör



0016.347816



0016.347817



0016.347916



0016.347858



0016.347860



6mm







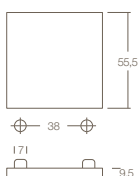

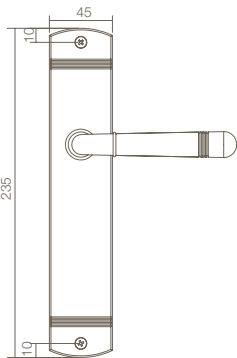
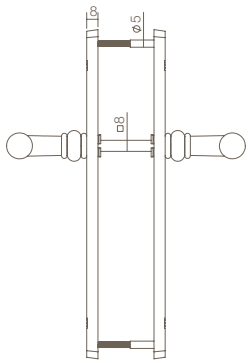

7mm



0019.212602





0016.170511		-----	
0016.170511A		-----	
0016.170511B		-----	
0016.170526			72mm
0016.170526A			72mm
0016.170536			72mm
0016.170569			WC 78/8



1705

0016.170511

Deurkruk Emily vastdraaibaar met veer op langschild. Chromom.



Springloaded door handle Emily on long plate. Chrome.



Türdrücker Emily festdrehbar gelagert mit feder auf Langschild. Chrom.

Béquille Emily sertie sur plaque longue avec ressort. Chromé.

Accessoires

Accessories
Zubehör



0016.617050



Chroom - Chrome - Chrom - Chromé

Buitendeurbeslag - Rond / Ovaal

0016

Exterior door hardware - Round / Oval

Außentürbeschläge - Rund / Oval

Garnitures de porte extérieure - Ronde / Ovale



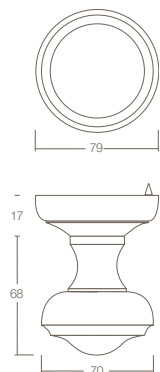
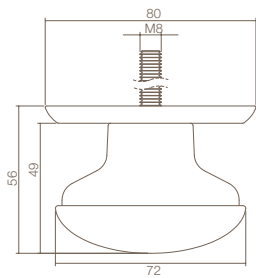
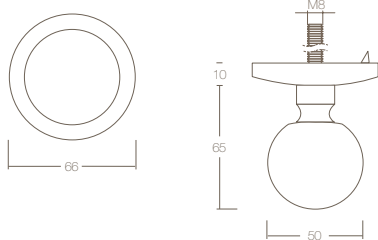
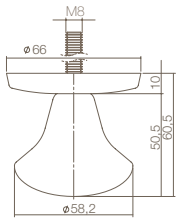

393030

0016.393030

Voordeurknop paddenstoel vast. Doorgaande bevestiging M8. Chromom.



Front door knob mushroom not turnable. Bolt through fixing M8. Chrome.

Haustürknopf Pilz fest mit einseitiger Befestigung M8. Chromom.

Bouton d'entrée fixe champignon. Fixation traversante M8. Chromé.



393031

0016.393031

Voordeurknop bolrond vast. Doorgaande bevestiging M8. Chromom.



Front door knob. Not turnable with bolt. Bolt through fixing M8. Chrome.

Haustürknopf fest mit durchgehender Befestigung M8. Chromom.

Bouton d'entrée fixe petite boule. Fixation traversante M8. Chromé.



393033

0016.393033

Voordeurknop zwaar vast. Doorgaande bevestiging M8. Chromom.



Front door knob. Not turnable with bolt. Bolt through fixing M8. Chrome.

Haustürknopf fest mit durchgehender Befestigung M8. Chromom.

Bouton d'entrée fixe grande. Fixation traversante M8. Chromé.



393034

0016.393034

Voordeurknop Venere vast. Doorgaande bevestiging M8. Chromom.



Front door knob Venere. Not turnable with bolt. Bolt through fixing M8. Chrome.

Haustürknopf Venere. Fest mit durchgehender Befestigung M8. Chromom.

Bouton d'entrée Venere fixe. Fixation traversante M8. Chromé.

Accessoires

Accessories
Zubehör



0099.997470

AISI
304

Schroefdraad met rvs eindkap t.b.v. bevestiging voordeurknop. 304 RVS geborsteld.

Change spindle for front door knob, including a cover plate. 304 brushed stainless steel.

Gewindestift mit Hutmutter für Haustürknopf. Edelstahl 304 gebürstet.

Fixation traversante pour bouton d'entrée. Inox mat AISI 304.

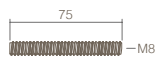

0016.397500

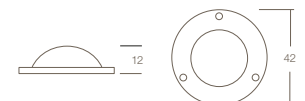

Afdeksplaatje t.b.v. bout. Chromom.

Bolt cover plate. Chrome.

Abdeckplatte für Bolzen. Chromom.

Ce cache boulon couvre la vis du bouton. Chromé.

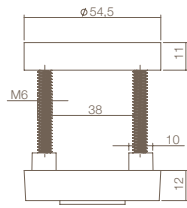

0016.375100

M6



3751

0016.375100

PC veiligheidsrozet rond verdekt met kerntrek-beveiliging. M6. Chrom.



Security euro profile cylinder escutcheon round, with cylinder protection. With invisible fixing, M6. Chrome.



PZ Schutzrosette verdeckt Rund, mit Kernziehschutz. M6. Chrom.



Entrée de cylindre de haute sécurité ronde avec cache anti-forage. Fixation invisible. M6. Chromé.

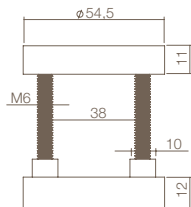
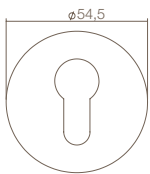

0016.375060

M6



3750

0016.375060

PC veiligheidsrozet rond verdekt. M6. Chrom.



Security euro profile cylinder escutcheon round. With invisible fixing. M6. Chrome



PZ Schutzrosette verdeckt Rund. M6. Chrom.



Entrée de cylindre de sécurité ronde. Fixation invisible. M6. Chromé.

Accessoires

Accessories
Zubehör



0099.990120	M6	70mm	58 - 64
0099.990122	M6	80mm	68 - 74
0099.990121	M6	90mm	78 - 84

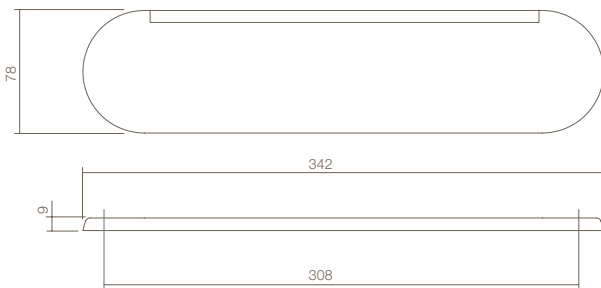
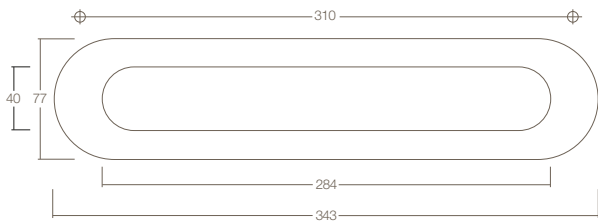

4000



0016.400005

Briefplaat ovaal met veer. Chroom.



Springloaded oval letter plate. Chrome.

Briefeinwurf oval mit Feder. Chrom.

Plaque-à-lettres ovale avec ressort. Chromé.

4015



0016.401500

Tochtwering ovaal met borstel en afdekklep verdekt. Chroom.



Oval draught flap with brush and rain edge. Chrome.

Zugklappe oval mit Bürstenleiste und Abdeckklappe verdeckt. Chrom.

Plaque-à-lettres anti courants d'air, ovale, avec clapet. Chromé.

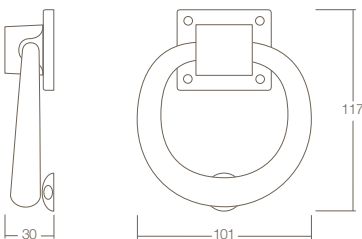
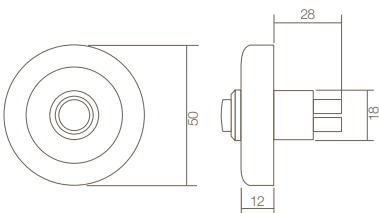
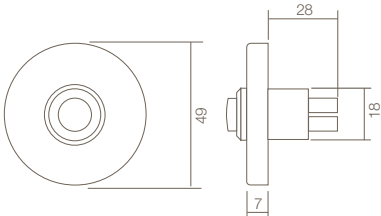
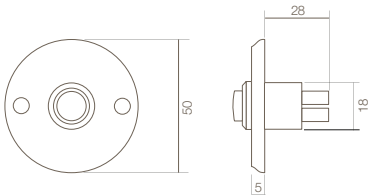
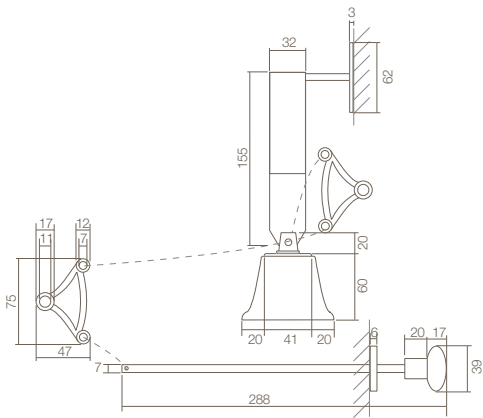

- 0016.399010** Trekbel set. ø80mm. Chromo.
 Bell pull set. ø80mm. Chrome.
 Zugklingel garnitur. ø80mm. Chrom.
 Cloche d'appel complète. ø80mm. Chromé.



- 0016.399023** Beldrukker rond. Opschroevend. Chromo.
 Round bell push. Screw mounting. Chrome.
 Klingelplatte rund. Schraubbar Chrom.
 Sonnette ronde. Fixation visible. Chromé.



- 0016.399027** Beldrukker rond verdekt. Chromo.
 Round concealed bell push. Chrome.
 Klingelplatte rund. Verdekt. Chrom.
 Sonnette ronde. Fixation invisible. Chromé.



- 0016.399031** Beldrukker rond met rand, verdekt. Chromo.
 Concealed round bell push with edge. Chrome.
 Klingelplatte rund mit Rand. Verdekt. Chrom.
 Sonnette ronde avec bord. Fixation invisible. Chromé.



- 0016.403500** Deurklopper rond. Chromo.
 Doorknocker round. Chrome.
 Türklopper rund. Chrom.
 Heurtoir de porte rond. Chromé.



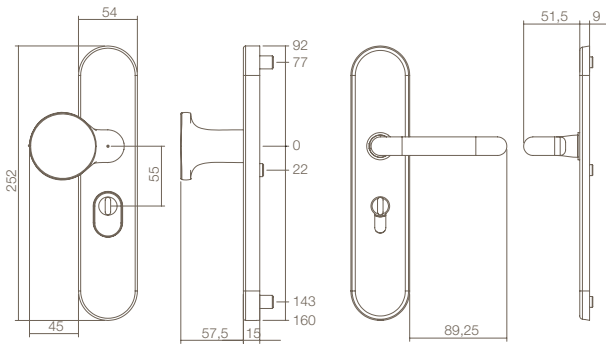

0016.382029		55mm
0016.382036		72mm
0016.382049		92mm



3820

0016.382036

Veiligheidschilden met kerntrekbeveiliging greep/kruk los. Krukhals \varnothing 18mm. Links of rechts te monteren. Stift M14 x 8 x 75mm. Chromom.



Security plates pull/lever with cylinder protection. Pull is reversible. Insert \varnothing 18mm. Spindle M14 x 8 x 75mm. Chrome.

Sicherheitsgarnitur Drücker/Griffplatte mit Kernziehschutz. Rechts/links verwendbar. Drücker Hals \varnothing 18mm. Stift M14 x 8 x 75mm. Chrom.

Garnitures de sécurité avec cache anti-forage et tirant fixe. Tirant réversible. Béquille seule, cou de \varnothing 18mm, droite ou gauche. Tige M14 x 8 x 75mm. Chromé.

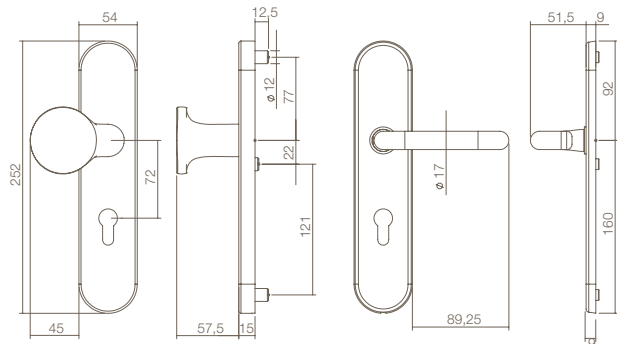

0016.384629		55mm
0016.384636		72mm
0016.384649		92mm



3846

0016.384629

Veiligheidschilden greep/kruk los. Krukhals \varnothing 18mm. Links of rechts te monteren. Stift M14 x 8 x 75mm. Chromom.



Security plates pull/lever. Pull is reversible. Insert \varnothing 18mm. Spindle M14 x 8 x 75mm. Chrome.

Sicherheitsgarnitur Drücker/Griffplatte. Rechts/links verwendbar. Drücker Hals \varnothing 18mm. Stift M14 x 8 x 75mm. Chrom.

Garnitures de sécurité. Tirant réversible. Béquille seule, cou de \varnothing 18mm, droite ou gauche. Tige M14 x 8 x 75mm. Chromé.

Accessoires

Accessories
Zubehör



0099.990120	M6	70mm	58 - 64
0099.990122	M6	80mm	68 - 74
0099.990121	M6	90mm	78 - 84



0099.975343	M14	\square 8x70mm	\leq 42
0099.975363	M14	\square 8x90mm	\leq 60
0099.975364	M14	\square 8x120mm	\leq 90

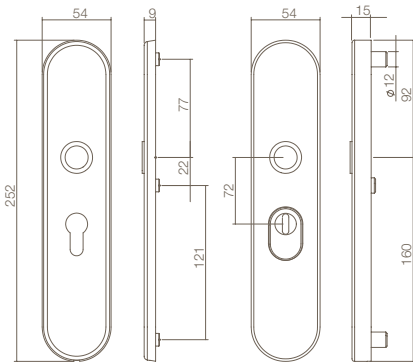

0016.382129		55mm
0016.382136		72mm
0016.382149		92mm

Optie: Te combineren met deurkrukken op pagina 13, 14, 17, 18.

Option: Combine with leverhandles from page 13, 14, 17, 18.

Option: Zu kombinieren mit Türdrücker auf Seite 13, 14, 17, 18.

Option: Une combinaison possible avec les béquilles de la page 13, 14, 17, 18.



3821

0016.382129

Veiligheidsschilden doorgaand met kerntrek beveiliging. Krukhals ø18mm. Chrom.



Security plates with cylinder protection. Insert ø18mm. Chrome.



Schutzbeschlag mit Kernziehschutz. Drücker Hals ø18mm. Chrom.



Garnitures de sécurité avec cache anti-forage. Béquille, cou de ø18mm. Chromé.

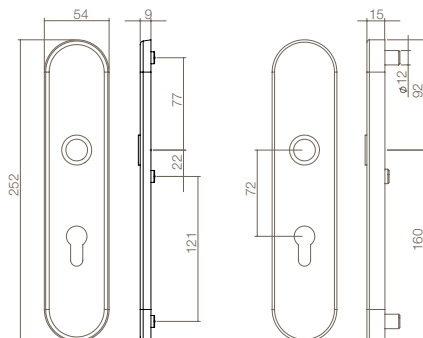

0016.381929		55mm
0016.381936		72mm
0016.381949		92mm

Optie: Te combineren met deurkrukken op pagina 13, 14, 17, 18.

Option: Combine with leverhandles from page 13, 14, 17, 18.

Option: Zu kombinieren mit Türdrücker auf Seite 13, 14, 17, 18.

Option: Une combinaison possible avec les béquilles de la page 13, 14, 17, 18.



3819

0016.381929

Veiligheidsschilden doorgaand. Krukhals ø18mm. Chrom.



Security plates. Insert ø18mm. Chrome.



Schutzbeschlag. Drücker Hals ø18mm. Chrom.



Garnitures de sécurité. Béquille, cou de ø18mm. Chromé.



Accessoires

Accessories
Zubehör



0099.990120	M6		70mm	58 - 64
0099.990122	M6		80mm	68 - 74
0099.990121	M6		90mm	78 - 84



0099.975000		8x105mm	≤ 42
0099.975001		8x120mm	≤ 58
0099.975002		8x150mm	≤ 90

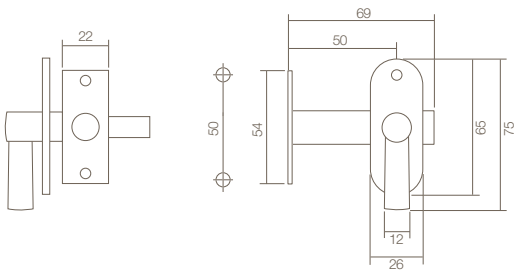
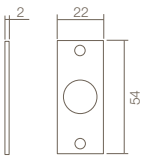
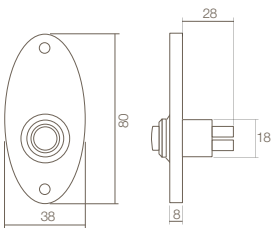
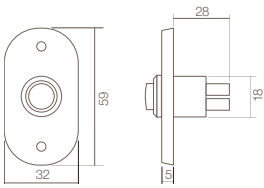

3990

0016.399025

Beldrukker opschroevend, ovaal. Chroom.



Oval bell push. Screw mounting. Chrome.

Klingelplatte oval. Schraubbar. Chrom.

Sonnnette ovale. Fixation visible. Chromé.



3990

0016.399028

Beldrukker opschroevend, ellips. Chroom.



Bell push ellipse. Screw mounting. Chrome.

Klingelplatte Ellipse. Schraubbar. Chrom.

Sonnnette Ellipse. Fixation visible. Chromé.



4055

0016.405525

Insteekgrendel. Chroom.



Mortise latch. Chrome.

Einsteck-Verriegelung. Chrom.

Verrou à larder. Chromé.





Chroom - Chrome - Chrom - Chromé

Buitendeurbeslag - Vierkant

0016

Exterior door hardware - Square

Außentürbeschläge - Eckig

Garnitures de porte extérieure - Carrée

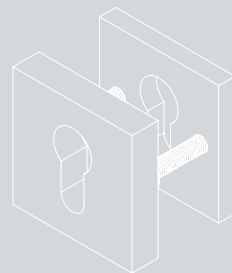

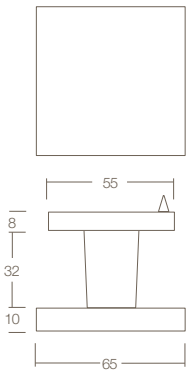

0016.393046

M8



3930

0016.393046

Voordeurknop vierkant vast centraal.
Doorgaande bevestiging M8. Chroom.



Front door knob fixed centered.
Bolt through fixing M8. Chrome.



Haustürknopf fest mittig mit durchgehender
Befestigung M8. Chrom.

Bouton d'entrée central fixe carrée.
Fixation traversante M8. Chromé.

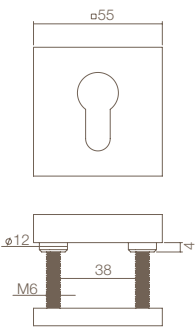

0016.375140

M6



3751

0016.375140

PC veiligheidsrozet massief vierkant.
Zichtbare bevestiging M6. Chroom.



Square euro profile cylinder. With visible
fixing M6. Chrome.



PZ Schutzrosette eckig. Mit sichtbarer
Befestigung M6. Chrom.



Entrée de cylindre de sécurité massive carrée.
Fixation visible M6. Chromé.

Accessoires

Accessories

Zubehör



0099.997470



Schroefdraad met rvs eindkap t.b.v. bevestiging voordeurknop.
304 RVS geborsteld.

Change spindle for front door knob, including a cover plate.
304 brushed stainless steel.

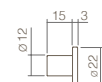

Gewindesttift mit Hutmutter für Haustürknopf.
Edelstahl 304 gebürstet.

Fixation traversante pour bouton d'entrée.
Inox mat AISI 304.



0099.990120



70mm

58 - 64

0099.990122

M6

80mm

68 - 74

0099.990121

M6

90mm

78 - 84

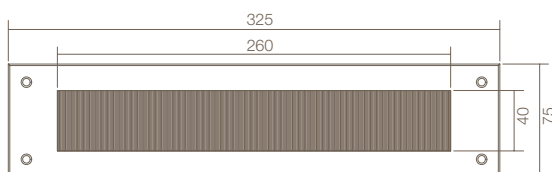
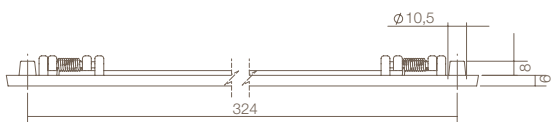
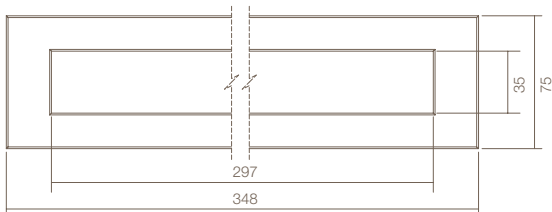
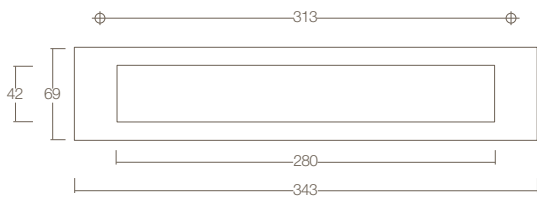
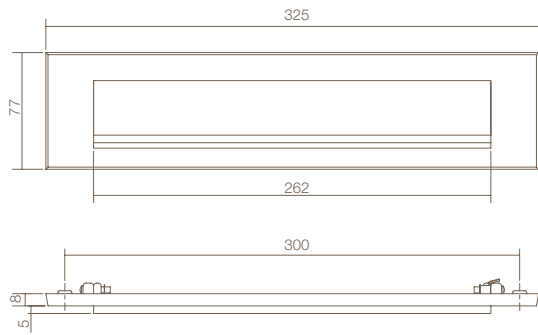

4000



0016.400001 Briefplaat rechthoekig met regenrand. Klep half naar buitendraaiend. Chroom.



Letter plate square with rain edge, opens half outwards. Chrome.

Briefeinwurf rechteckig mit Tropfkante. Klappe halb nach außen öffnend. Chrom.

Plaque-à-lettres rectangulaire. S'ouvrant à moitié vers l'extérieur. Chromé.

4000



0016.400003 Briefplaat rechthoekig. Klep half naar buitendraaiend. Chroom.



Letter plate square, opens half outwards. Chrome.

Briefeinwurf rechteckig Klappe halb nach außen öffnend. Chrom.

Plaque-à-lettres rectangulaire. S'ouvrant à moitié vers l'extérieur. Chromé.

4000



0016.400004 Briefplaat rechthoekig met veer. Chroom.



Square springloaded letter plate. Chrome.

Briefeinwurf rechteckig. Mit feder. Chrom.

Plaque-à-lettres rectangulaire avec ressort. Chromé.

4015



0016.401503 Tochtwering rechthoek met borstel. Chroom.



Draught flap rectangular with brush. Chrome.

Zugklappe rechteckig mit Bürstenleiste. Chrom.

Plaque-à-lettres rectangulaire anti courants d'air avec brosse. Chromé.

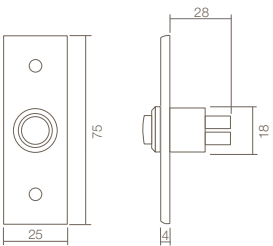
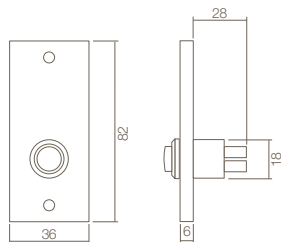
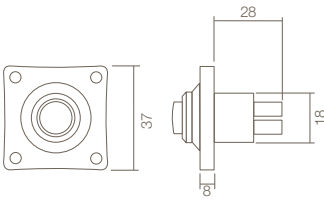

3990

0016.399029

Beldrukker vierkant klein. Chroom.



Square bell push. Chrome.

Klingelplatte eckig. Chrom.

Sonnette carrée petite. Chromé.



3990

0016.399032

Beldrukker rechthoekig. Chroom.



Square bell push. Chrome.

Klingelplatte eckig. Chrom.

Sonnette rectangulaire. Chromé.



3990

0016.399033

Beldrukker rechthoekig smal. Chroom.



Square bell push small. Chrome.

Klingelplatte eckig schmal. Chrom.

Sonnette rectangulaire rétrécir. Chromé.

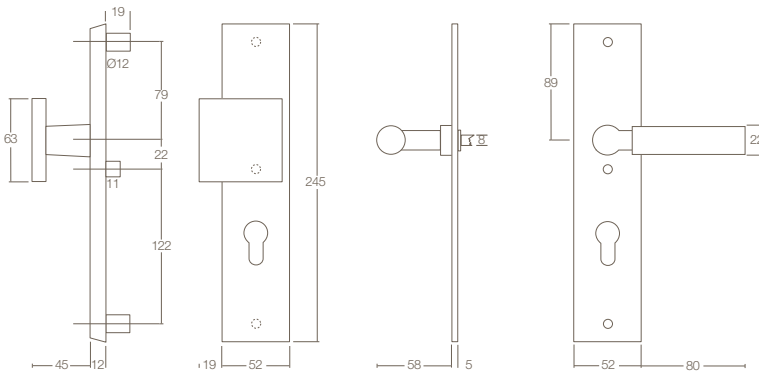

0016.382429		55mm
0016.382436		72mm
0016.382449		92mm



3824

0016.382429

Veiligheidschilden rechthoekig massief.
Stift M14x8x75mm. Greep/kruk. Chromo.



Security plates escutcheon. Spindle M14x8x75mm.
Pull/lever. Chrome.



Sicherheitsgarnitur Langschild Stift M14x8x75mm.
Griff/Drücker. Chrom.



Garniture de sécurité rectangulaire.
Tige M14x8x75mm. Béquille modèle Bau-Stil.
Chromé.

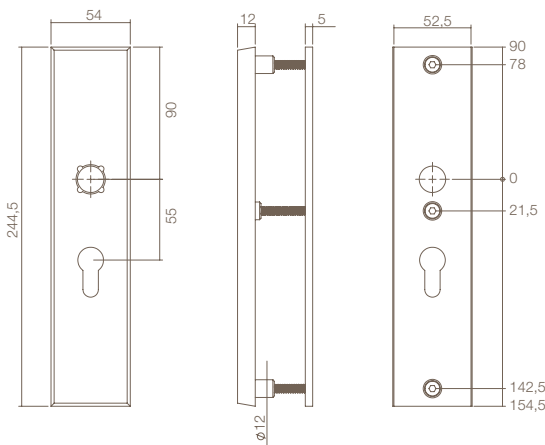

0016.382529		55mm
0016.382536		72mm
0016.382549		92mm



3825

0016.382529

Veiligheidschilden rechthoekig massief.
Krukhals ø18mm. Chromo.



Security plates escutcheon. Insert ø18mm
Chrome.



Sicherheitsgarnitur Langschild. Drücker Hals
ø18mm. Chrom.



Garniture de sécurité rectangulaire avec cou
de ø18mm. Chromé.



Accessoires

Accessories
Zubehör



0099.990120	M6	70mm	58 - 64
0099.990122	M6	80mm	68 - 74
0099.990121	M6	90mm	78 - 84



0099.975343	M14	□ 8x75mm	≤ 42
0099.975363	M14	□ 8x90mm	≤ 60
0099.975364	M14	□ 8x120mm	≤ 90



0099.975000	□ 8x105mm	≤ 42
0099.975001	□ 8x120mm	≤ 58
0099.975002	□ 8x150mm	≤ 90



7

Chroom - Chrome - Chrom - Chromé

Buitendeurbeslag - Huiscijfers

0016

Exterior door hardware - House numbers

Außentürbeschläge - Hausnummern

Garnitures de portes extérieure - Numéros de maison



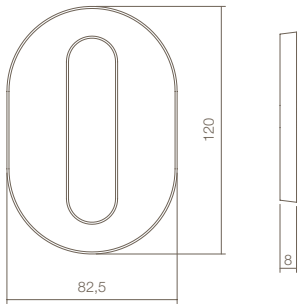

0016.402020	0	120mm
0016.402021	1	120mm
0016.402022	2	120mm
0016.402023	3	120mm
0016.402024	4	120mm
0016.402025	5	120mm
0016.402026	6	120mm
0016.402027	7	120mm
0016.402028	8	120mm
0016.402029	9	120mm



4020

0016.40202x

Huiscijfer 120mm. Inclusief bevestiging. Chroom.



House number 120mm. Including mounting material. Chrome.

Hausnummer 120mm breit inkl. Befestigung. Chrom.

Numéro de maison 120mm. Fixation fournie. Chromé.

0 1 2 3 4
5 6 7 8 9

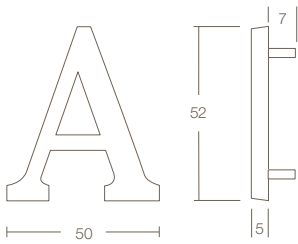

0016.402501	A	50mm
0016.402502	B	50mm
0016.402503	C	50mm



4025

0016.40250x

Huisletter. Inclusief bevestiging. Chroom.



House letter. Including mounting material. Chrome.

Hausnummer inkl. Befestigung. Chrom.

Lettre de maison. Fixation fournie. Chromé.

A B C

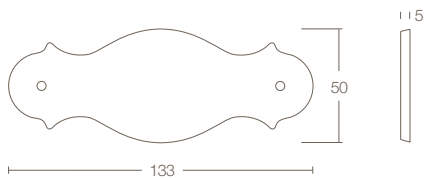

4040

0016.404002

Naamplaat 9203. Chroom.



Nameplate 9203. Chrome.

Namensschild 9203. Chrom.

Plaque signalétique 9203. Chromé.





Chroom - Chrome - Chrom - Chromé

Raambeslag - Raamsluitingen

0016

Window fittings - Window closers

Fensterbeschläge - Fenstersicherung

Garnitures de fenêtres - Béquilles de fenêtre

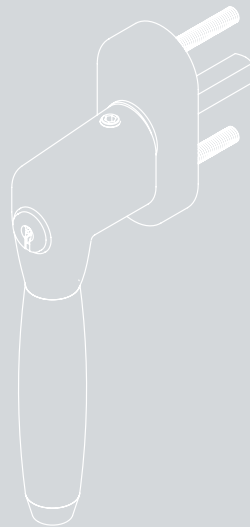

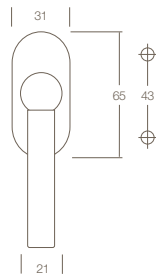
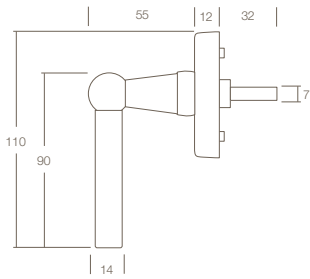

6050

0016.605011

Raamkruk L-model. Chroom.



Window handle L-model. Chrome.

Fenstergriff L-model. Chrom.

Béquille de fenêtre modèle L Chromé.

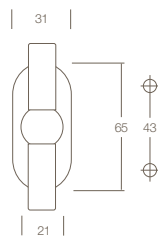
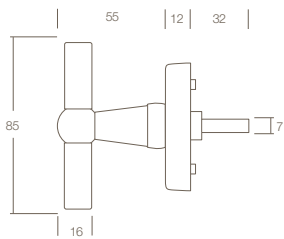

6050

0016.605013

Raamkruk T-model. Chroom.



Window handle T-model. Chrome.

Fenstergriff T-model. Chrom.

Béquille de fenêtre modèle T. Chromé.

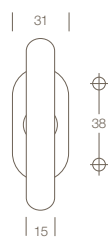
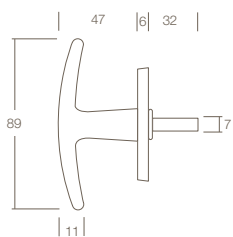

6050

0016.605014

Raamkruk T-model. klein. Chroom.



Window handle T-model. Chrome.

Fenstergriff T-model. Chrom.

Béquille de fenêtre modèle T petit. Chromé.

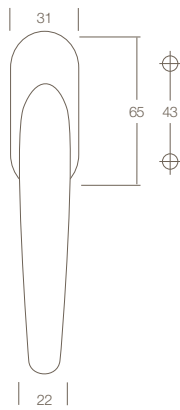
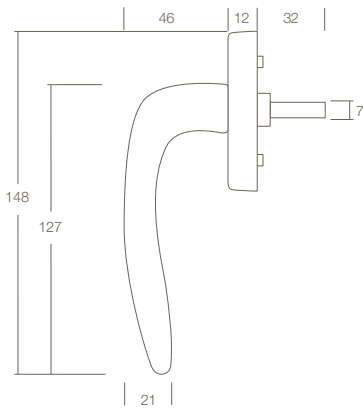

6050

0016.605020

Raamkruk Ellips. Chroom.



Window handle ellips. Chrome.

Fenstergriff Ellipse. Chrom.

Béquille de fenêtre Ellipse. Chromé.

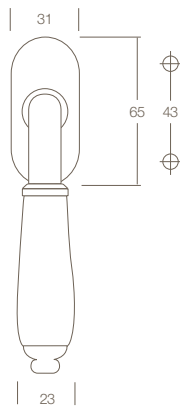
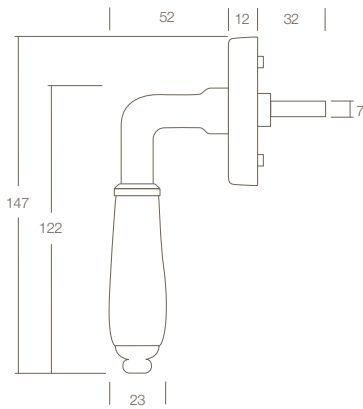

6050

0016.605070

Raamkruk Courgette. Chroom/zwart.



Window handle Courgette. Chrome/black.

Fenstergriff Courgette Chrom/Schwarz.

Béquille de fenêtre Courgette. Chromé/noir.

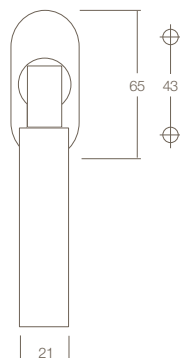
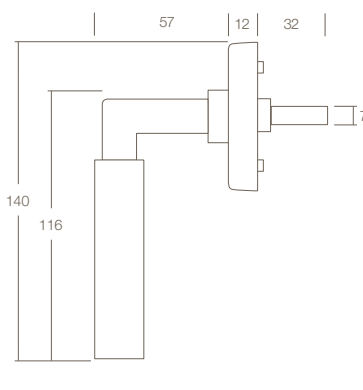

6050

0016.605090

Raamkruk Bau-stil. Chroom.



Window handle Bau-stil. Chrome.

Fenstergriff Bau-stil. Chrom.

Béquille de fenêtre Bau-stil. Chromé.

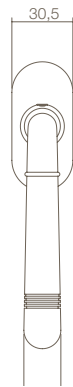
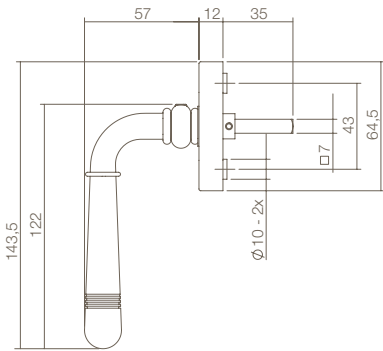

6170

0016.617050

Raamkruk Emily. Chroom.



Window handle Emily. Chrome.

Fenstergriff Emily. Chrom.

Béquille de fenêtre Emily. Chromé.

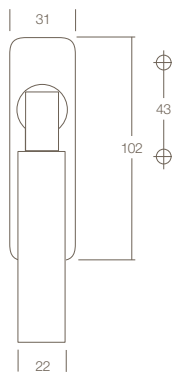
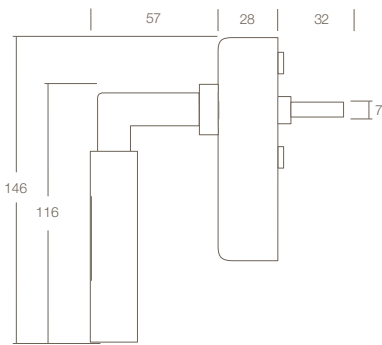

6616

0016.661620

Raamkruk Bau-stil afsluitbaar. Chroom.



Lockable window handle Bau-stil. Chrome.

Fenstergriff Bau-stil. Abschließbar. Chrom.

Béquille de fenêtre Bau-stil. Verrouillable. Chromé.

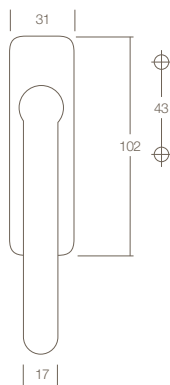
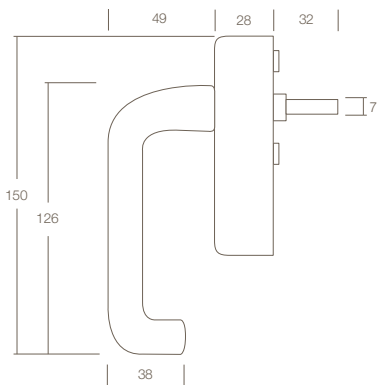

6616

0016.661630

Raamkruk U model afsluitbaar. Chroom.



Lockable window handle U model. Chrome.

Fenstergriff Rund. Abschließbar. Chrom.

Béquille de fenêtre modèle U. Verrouillable. Chromé.

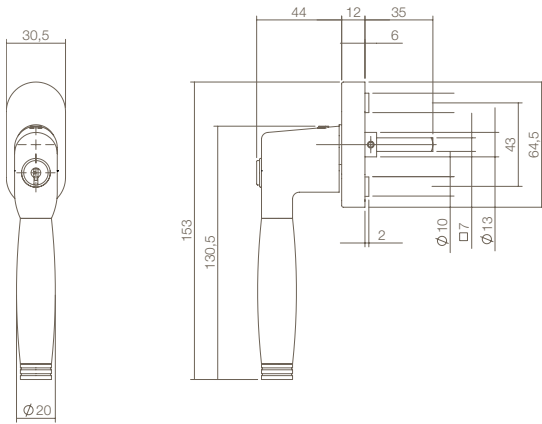
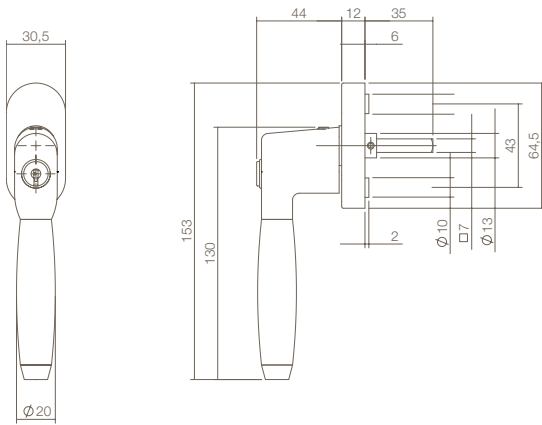

6616

0016.661645

Raamkruk Ton 400 afsluitbaar op ovaal rozet. Chrom/ebbenhout.



Lockable window handle Ton 400 on oval rose. Chrome/ebony.

Fenstergriff Ton 400. Abschließbar auf ovaler Rosette. Chrom/Ebenholz.

Béquille de fenêtre Ton 400. Verrouillable sur rosace ovale. Chromé/bois d'ébène.



6616

0016.661646

Raamkruk Ton 222 afsluitbaar op ovaal rozet. Chrom/ebbenhout.



Lockable window handle Ton 222 on oval rose. Chrome/ebony.

Fenstergriff Ton 222. Abschließbar auf ovaler Rosette. Chrom/Ebenholz.

Béquille de fenêtre Ton 222. Verrouillable sur rosace ovale. Chromé/bois d'ébène.

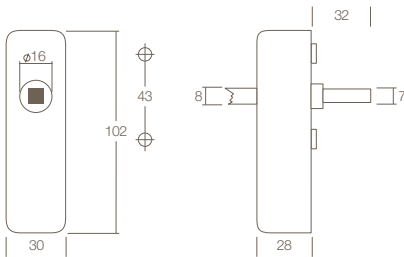
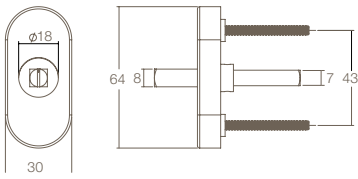

6050

0016.605000

Onderconstructie tbv raamkruk met hals \varnothing 18mm. Chromom



Baseplate for window handle with a \varnothing 18mm insert. Chrome.

Unterkonstruktion für Fenstergriffe mit \varnothing 18mm Drückerhals. Chrom.

Sous-construction pour béquille de fenêtre. Cou \varnothing 18mm. Chromé.

Optie: Te combineren met deurkrukken op pagina 12 - 18.

Option: Combine with doorhandles from page 12 - 18.

Option: Zu kombinieren mit Türdrücker auf Seite 12 - 18.

Option: Combinasion possible avec les béquilles de la page 12 - 18.



6616

0016.661600

Afsluitbare onderconstructie tbv raamkruk met hals \varnothing 16mm.



Lock construction for window handle with a \varnothing 16mm insert. Chrome

Abschließbare Utnerkonstruktion für Fenstergriffe mit \varnothing 16mm Drückerhals. Chrom

Sous-construction pour béquille de fenêtre avec clé. Cou \varnothing 16mm. Chromé.

Optie: Te combineren met deurkrukken op pagina 12 - 18.

Option: Combine with doorhandles from page 12 - 18.

Option: Zu kombinieren mit Türdrücker auf Seite 12 - 18.

Option: Combinasion possible avec les béquilles de la page 12 - 18.

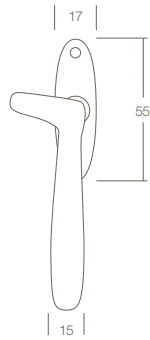
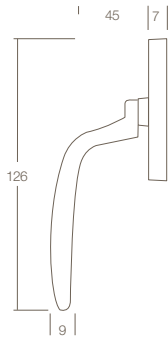
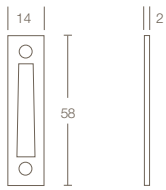

0016.561550A

0016.561550B

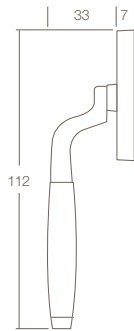
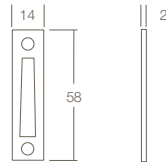
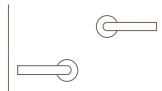

0016.561560A

0016.561560B

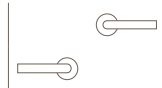

561550

0016.561550A

Raamsluiting Dudok, rechts. Chroom.



Window closer Dudok, right. Chrome.

Fenstersicherung Dudok, rechts. Chrom.

Crémone Dudok, droite. Chromé.



561560

0016.561560A

Raamsluiting, rechts. Chroom/zwart hout.



Window closer, right. Chrome/black wood.

Fenstersicherung, rechts.
Chrom/Schwarzes Holz.

Crémone, droite. Chromé/bois noir.

Accessoires

Accessories
Zubehör



0016.561540

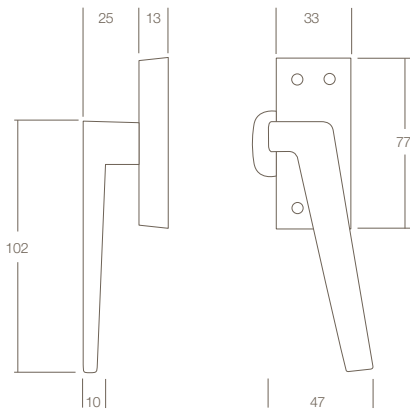

0016.561510A

0016.561510B

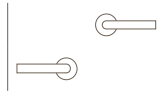
**561510****0016.561510A** Raamsluiting met nok, rechts. Chromo.

Window closer with lug, right. Chrome.

Fenstersicherung mit Stütznock, rechts. Chrom.

Béquille de fenêtre en applique, droite. Chromé.

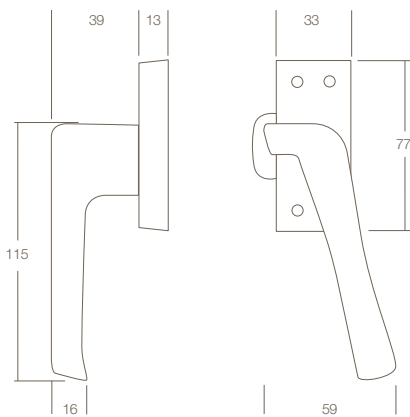

0016.561520A

0016.561520B

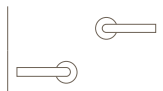
**561520****0016.561520A** Raamsluiting met nok zwaar, rechts. Chromo.

Window closer with lug, right. Chrome.

Fenstersicherung mit Stütznock, rechts. Chrom.

Béquille de fenêtre en applique, droite. Chromé.

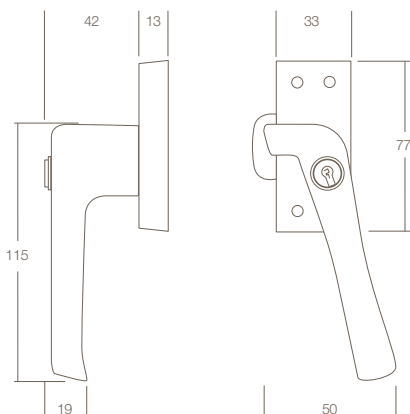

0016.561530A

0016.561530B

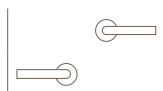
**561530****0016.561530A** Afsluitbare raamsluiting met nok, rechts. Chromo.

Lockable window closer with lug, right. Chrome.

Fenstersicherung. Abschließbar mit Stütznock, rechts. Chrom.

Béquille de fenêtre en applique verrouillable, droite. Chromé.



Accessoires

Accessories
Zubehör



0016.561500

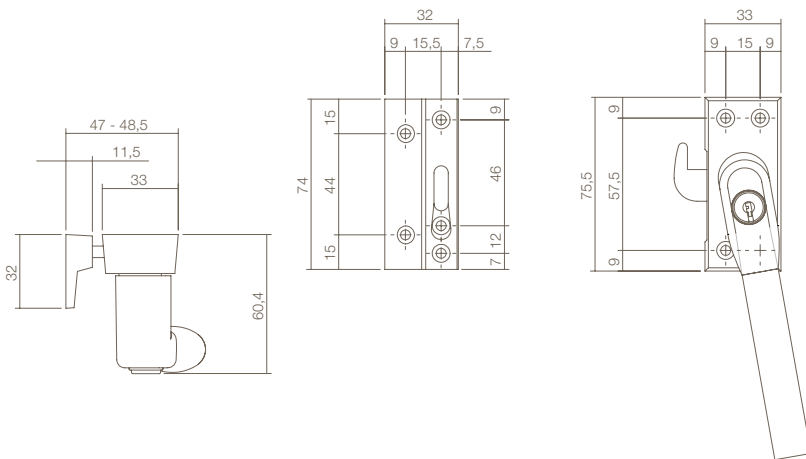

0016.661650A

0016.661651B

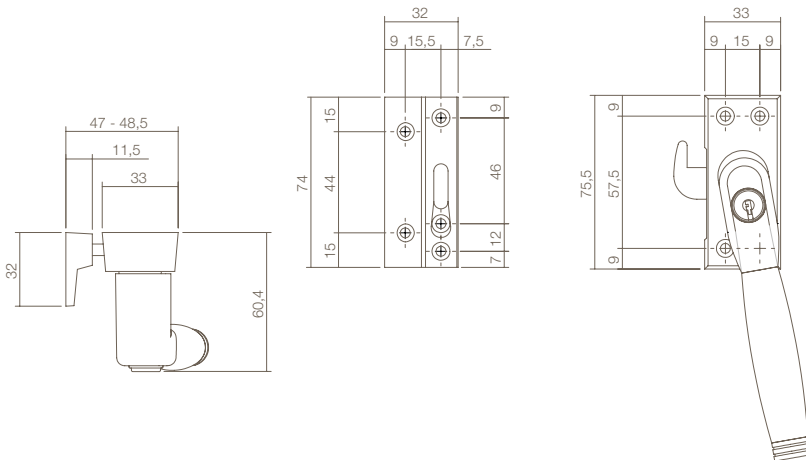
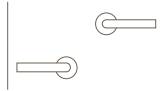

0016.661651A

0016.661651B

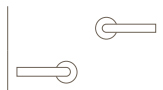

661650

0016.661650A

Afsluitbare raamsluiting recht, rechts. Compleet. Chrom.



Lockable window closer straight, right. Complete. Chrome.



Fenstersicherung. Abschließbar. Recht, rechts. Komplett. Chrom.

Béquille de fenêtre en applique verrouillable. Modèle droit, droite. Complet. Chromé.



661651

0016.661651A

Afsluitbare raamsluiting Ton 222, rechts. Compleet. Chrom/ebbenhout.



Lockable window closer Ton 222, right. Complete. Chrome/ebony.



Fenstersicherung. Abschließbar. Ton 222, rechts. Komplett. Chrom/Ebenholz.

Béquille de fenêtre en applique verrouillable. Modèle Ton 222, droite. Complet. Chromé/bois d'ébène.

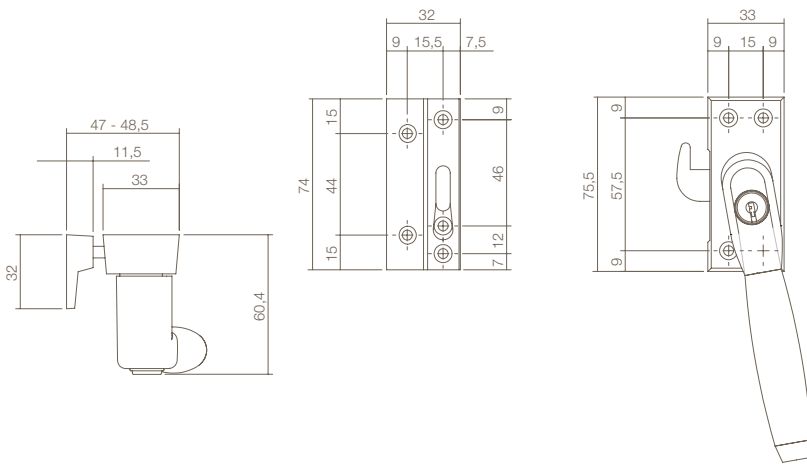

0016.661652A

0016.661652B

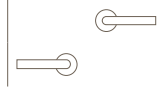

661652

0016.661652A Afsluitbare raamsluiting Ton 400, rechts. Compleet. Chrom/ebbenhout.



Lockable window closer Ton 400, right. Complete. Chrome/ebony.



Fenstersicherung. Abschließbar. Ton 400, rechts. Komplett. Chrom/Ebenholz.

Béquille de fenêtre en applique verrouillable. Modèle Ton 400, droite. Complet. Chromé/bois d'ébène.

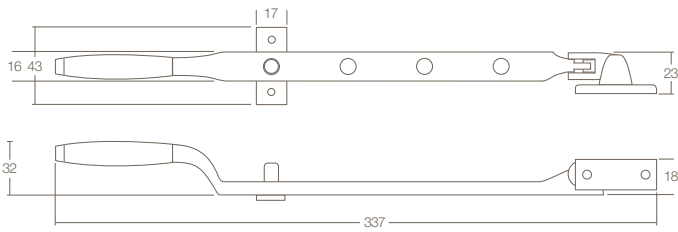

561580

0016.561580 Raamuitzetter Dudok met stelpen. Chrom.



Window casement stay Dudok.
With casement stay pin. Chrome.

Fensteraufsteller Dudok mit Stellstift. Chrom.

Entrebâilleur Dudok avec cheville de positionnement.
Chromé.

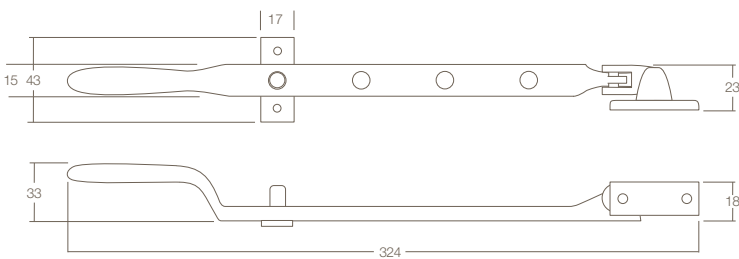

561581

0016.561581 Raamuitzetter met stelpen.
Chroom/zwart hout.



Window casement stay. With casement stay pin.
Chrome/black wood.

Fensteraufsteller mit Stellstift.
Chrom/Schwarzes Holz.

Entrebâilleur avec cheville de positionnement.
Chromé/bois noir.

Accessoires

Accessories
Zubehör



0016.561589

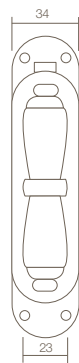
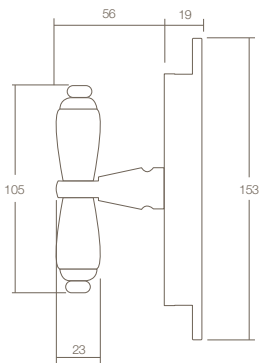
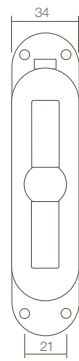
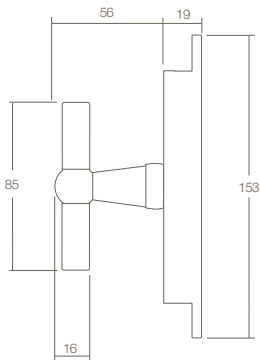

562020

0016.562020

Espagnolet T-kruk. Chrom.



Espagnolette T-model. Chrome.

Espagnolette T-Modell. Chrom.

Crémone kit "T". Chromé.



562025

0016.562025

Espagnolet kruiskruk. Chrom/zwart.



Espagnolette T-model. Chrome/black.

Espagnolette T-Modell. Chrom/Schwarz.

Crémone kit "T". Chromé/noir.

Accessoires

Accessories
Zubehör



0016.562000



0016.562002

0016.562007
2 x 125cm

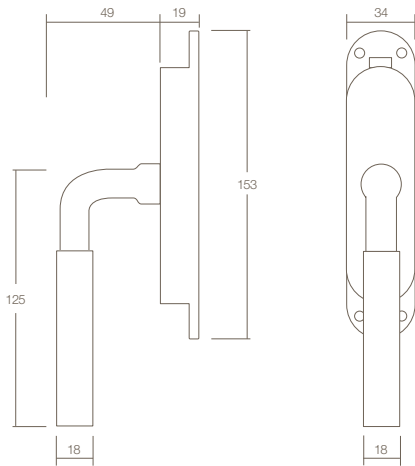

0016.562040A

0016.562040B

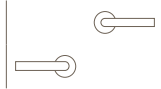

562040

0016.562040A

Espagnolet Palma, rechts. Chromo/zwart.



Espagnolette Palma, right. Chrome/black.

Espagnolette Palma, rechts. Chrom/Schwarz.

Crémone kit Palma, droite. Chromé/noir

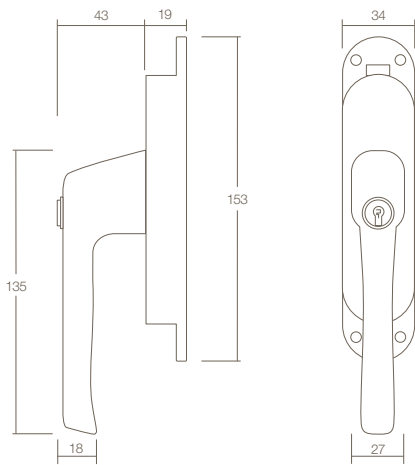

0016.562070A

0016.562070B

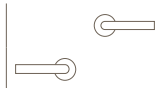

562070

0016.562070A

Afluitbare espagnolet kruik, rechts. Chromo.



Lockable espagnolette handle, right. Chrome.

Espagnolette abschließbar, rechts. Chrom.

Béquille de crémone verrouillable, droite. Chromé.

Accessoires

Accessories
Zubehör



0016.562000



0016.562002

0016.562007
2 x 125cm

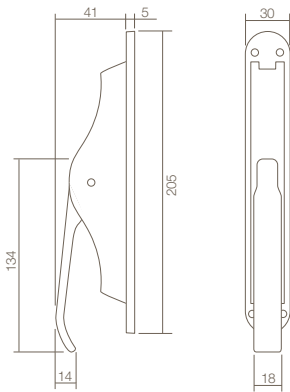

562020



0016.562030

Pomp-espagnolet. Chrom.



Espagnolette. Chrome.

Espagnolette. Chrom.

Espagnolette à levier. Chromé.

Accessoires

Accessories
Zubehör



0016.562000



0016.562002

0016.562004
2 x 125cm

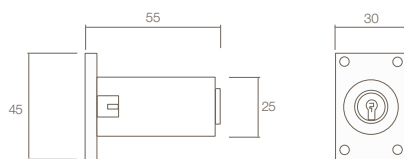
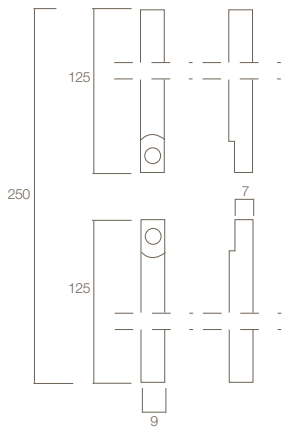
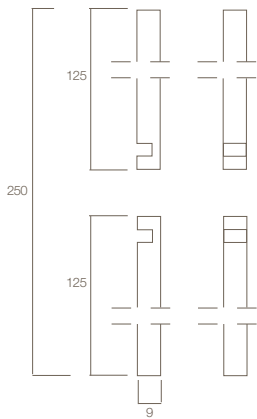

5620

0016.562004

Stangenset tbv. **pomp-espagnolet**. 2 x 125cm. Chrom.

Rods set for espagnolette. 2 x 125cm. Chrome.

Stangen set für Espagnolette. 2 x 125cm. Chrom.

Set tringles pour espagnolette à levier. 2 x 125cm. Chromé.



5620

0016.562007

Stangenset tbv. **kruk-espagnolet**. 2 x 125cm. Chrom.

Rods set for Espagnolette. 2 x 125cm. Chrome.

Stangen set für Espagnolette. 2 x 125cm. Chrom.

Set tringles pour crémone. 2 x 125cm. Chromé



5620

0016.562002

Espagnoletslot. Chrom.



Espagnolette lock. Chrome.

Espagnolette sperren. Chrom.

Verou pour espagnolette. Chromé.

Accessoires

Accessories
Zubehör



0016.562000



0016.562001



Chroom - Chrome - Chrom - Chromé

Toebehoren - Sierhulzen

0016

Accessories - Hinge covers

Zubehör - Übersteckhüls

Accessoires - Caches-paumelles



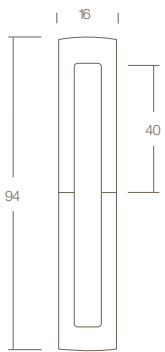

ø14mm

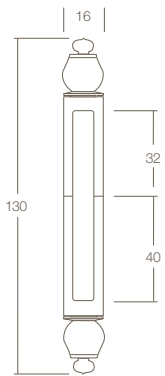

ø14mm



4540

0016.454000

Sierhuls stomp 40/40mm. voor paumel ø14mm. Chrom.



Decorative hinge cover blunt 40/40mm. Chrome.

Übersteckhüls Stumpf 40/40mm. Chrom.

Caches-paumelles modern 40/40mm pour paumelles ø14mm. Chromé.



4540

0016.454001

Sierhuls met knop 32/40mm voor paumel ø14mm. Chrom.



Decorative hinge cover 32/40mm. Chrome.

Übersteckhüls 32/40mm. Chrom.

Caches-paumelles avec bouton 32/40mm. pour paumelles ø14mm. Chromé.

Chroom - Chrome - Chrom - Chromé

Toebehoren - Deurstoppers

0016

Accessories - Doorstops

Zubehör - Türstopper

Accessoires - Butoirs de porte

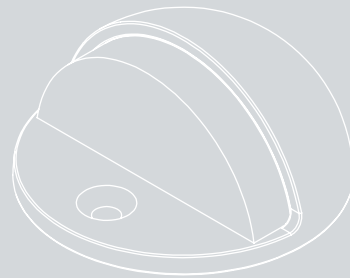

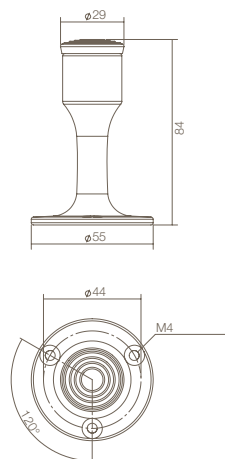
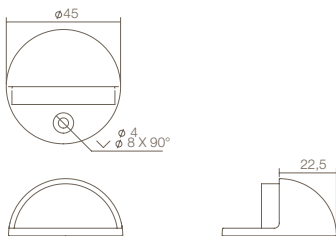
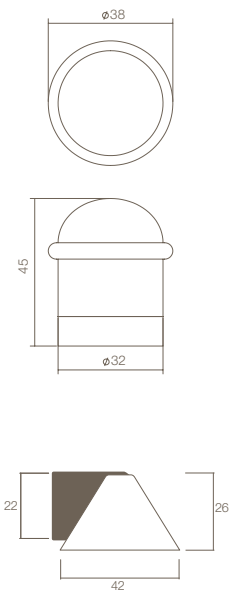

4420

0016.442000

Deurstop met ring. Chrom.
Vloermontage.



Doorstop with ring. Chrome.
Floor mounting.

Türstopper mit Ring. Chrom.
Bodenmontage.

Butoir de porte avec baque. Chromé.
Pose au sol.



4420

0016.442010

Deurstop taps. Chrom.
Vloermontage.



Door stop conical. Chrome.
Floor mounting.

Türstopper Kegelförmig. Chrom.
Bodenmontage.

Butoir de porte conique. Chromé.
Pose au sol.



4420

0016.442020

Deurstop rond model. Chrom.
Vloermontage.



Doorstop round. Chrome.
Floor mounting.

Türstopper Rund. Chrom.
Bodenmontage.

Butoir de porte modèle rond. Chromé.
Pose au sol.



4420

0016.442040

Deurstop recht model. Chrom.
Wandmontage.



Doorstop straight. Chrome.
Wall mounting.

Türstopper Recht. Chrom.
Wandmontage.

Butoir modèle droite. Chromé.
Pose mural.

Chroom - Chrome - Chrom - Chromé

Toebehoren - Schuifdeurbeslag

0016

Accessories - Sliding door fittings

Zubehör - Schiebetürbeschläge

Accessoires - Ferrures de portes coulissantes

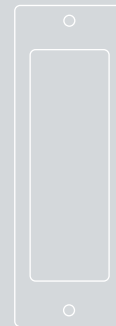

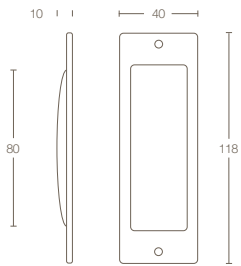

4476

0016.447600 Schuifdeurkom 120x40mm. Chrom.



Flush pull 120x40mm. Chrome.

Schiebetürmuschel 120x40mm. Chrom.

Poignée cuvette à encastrer rectangulaire, montage par vis, 120x40mm. Chromé.

Chroom - Chrome - Chrom - Chromé

Toebehoren - Deurgrepen

0016

Accessories - Pull handles

Zubehör - Stoßgriffe

Accessoires - Tirants

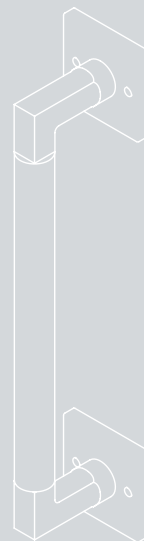

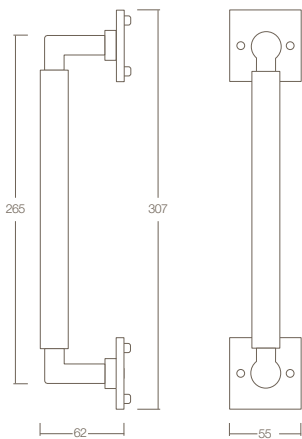
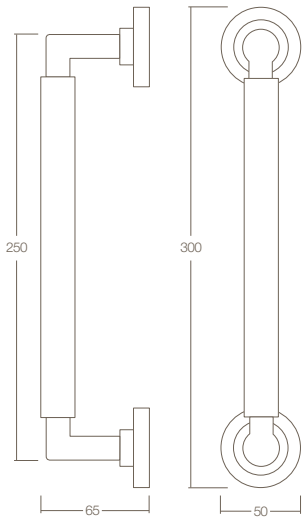

4261

0016.426180

Deurgreep Bau-Stil 250mm op rond rozet.
Eenzijdige bevestiging. Chromoom.



Pull handle Bau-Stil 250mm on round rose.
One side fixing. Chrome.

Stoßgriff Bau-Stil 250mm auf runder Rosette.
Einseitiger Befestigung. Chrom.

Tirant modèle Bau-Stil 250mm avec rosace ronde.
Montage unilatérale. Chromé.



4261

0016.426190

Deurgreep Bau-Stil op vierkant rozet.
Eenzijdige bevestiging. Chromoom.



Pull handle Bau-Stil on square rose. One side fixing.
Chrome.

Stoßgriff Bau-Stil auf Eckige Rosette.
Einseitiger Befestigung. Chrom.

Tirant modèle Bau-Stil avec rosace carrée.
Montage unilatérale. Chromé.

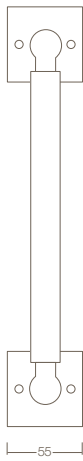
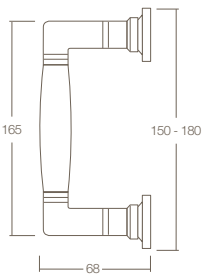
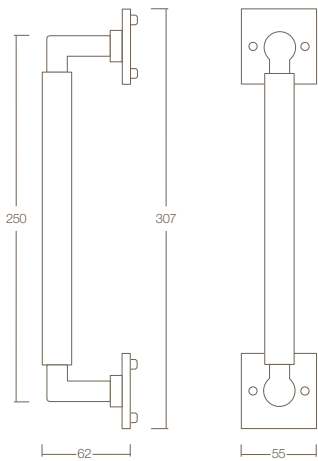

0016.426192	75/150mm
0016.426193	110/180mm



4261

0016.426191

Deurgreep Bau-Stil 250mm op vierkant rozet.
Eenzijdige bevestiging. Chroom/mat zwart.



Pull handle Bau-Stil 250mm on square rose.
One side fixing. Chrome/Satin black.

Stoßgriff Bau-Stil 250mm auf Eckige Rosette.
Einseitiger Befestigung. Chrom/Matt Schwarz.

Tirant modèle Bau-Stil 250mm avec rosace carrée.
Montage unilatérale. Chrome/noir mat.



4261

0016.426193

Deurgreep Ton 110/180mm op vierkant rozet.
Eenzijdige bevestiging. Chroom/ebbenhout.



Pull handle Ton 110/180mm on square rose.
One side fixing. Chrome/ebony.

Stoßgriff Ton 110/180mm auf Eckige Rosette.
Einseitiger Befestigung. Chrom/Ebenholz.

Tirant modèle Ton 110/180mm avec rosace carrée.
Montage unilatérale. Chrome/bois d'ébène.



Chroom - Chrome - Chrom - Chromé

Toebehoren - Meubelgrepen

0016

Accessories - Furniture handles

Zubehör - Möbelgriffe

Accessoires - Poignées de meuble

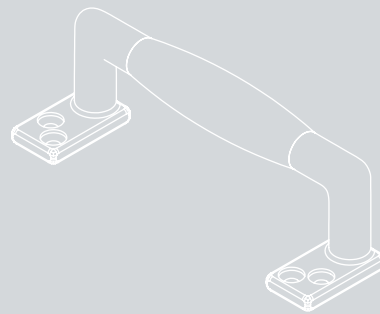

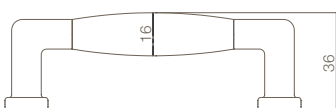
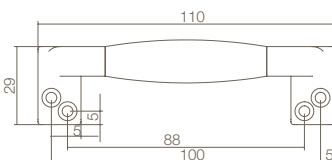
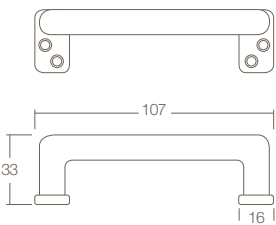
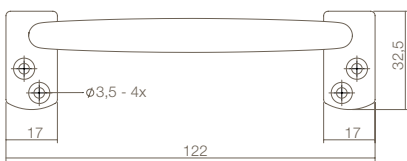
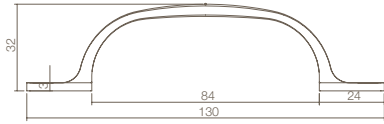
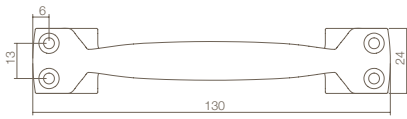

561600

0016.561600 Handgreep op vierkante voet 130mm. Chroom.



Handle on square base 130mm. Chrome.

Möbelgriff eckige Grundlage 130mm. Chrom.

Poignée avec base carrée 130mm. Chromé.



561601

0016.561601 Handgreep Haags model 122mm. Chroom.



Handle 122mm. Chrome.

Möbelgriff 122mm. Chrom.

Poignée modèle La Haye 122mm. Chromé.



561620

0016.561620 Handgreep recht 107mm. Chrome.



Handle straight 107mm. Chrome.

Möbelgriff Recht 107mm. Chrom.

Poignée modèle droit 107mm. Chromé.



561640

0016.561640 Handgreep recht 110mm. Chroom/ebbenhout.



Handle straight 110mm. Chrome/Ebony.

Möbelgriff Recht 110mm. Chrom/Ebenholz.

Poignée modèle droit 110mm.
Chromé/bois d'ébène.

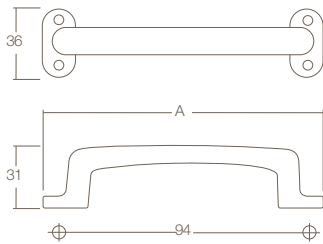

0016.561590

A
110mm

0016.561591

140mm



561590

0016.561590

Handgreep 777. Chroom.



Handle 777. Chrome.

Möbelgriff 777. Chrom.

Poignée 777. Chromé.

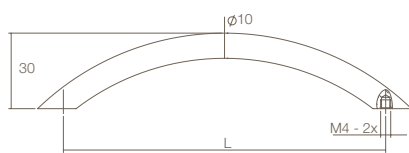

0016.875040

L
96mm

0016.875041

128mm

0016.875042

160mm



875040

0016.875040

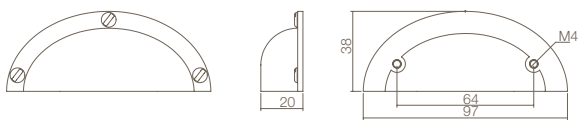
Greep gebogen \varnothing 10mm. Chroom.Handle bended \varnothing 10mm. Chrome.Möbelgriff gebeugt \varnothing 10mm. Chrom.Poignée de meuble courbe \varnothing 10mm. Chromé.

0016.875250

Kongreep 64/97mm. Chroom.



Grip 64/97mm. Chrome.

Möbelgriff 64/97mm. Chrom.

Poignée Coquille 64/97mm. Chromé.



875250

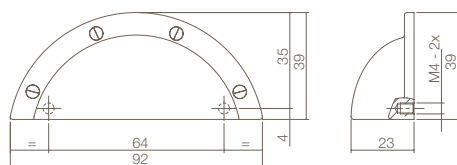

0016.875270

Kongreep zwaar 64mm. Chroom.



Grip 64mm. Chrome.

Möbelgriff 64mm. Chrom.

Poignée Coquille massive 64mm. Chromé.



875270

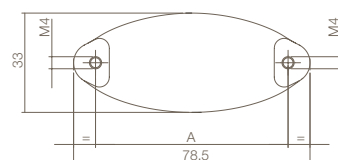
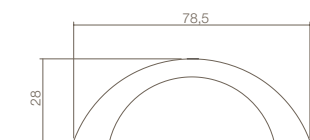
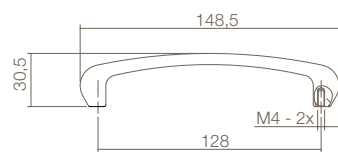
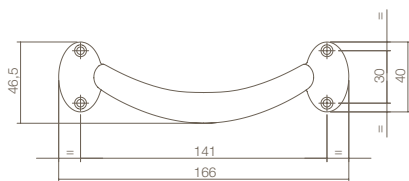
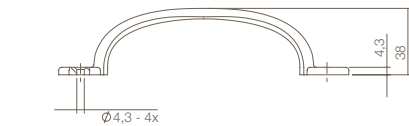
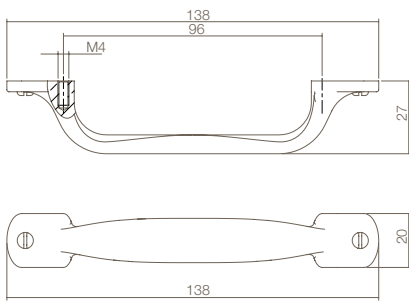

0016.875330

0016.875331

A

64mm

96mm



875280

0016.875280

Handgreep kort 96mm. Chromom.



Handle short 96mm. Chrome.

Möbelgriff kurz 96mm. Chrom.

Poignée de meuble courte 96mm. Chromé.



875290

0016.875290

Handgreep. 165mm. Chromom.



Handle 165mm. Chrome

Möbelgriff 165mm. Chrom.

Poignée 165mm. Chromé.



875310

0016.875310

Greep met bolle voet 128mm. Chromom.



Grip with convex base 128mm. Chrome.

Möbelgriff mit konvexen Basis 128mm. Chrom.

Poignée de meuble avec une base convexe 128mm. Chromé.



875330

0016.875330

Greep ellips breed.Chromom.



Grip ellipse. Chrome.

Möbelgriff Ellipse. Chrom

Poignée de meuble Ellipse. Chromé.

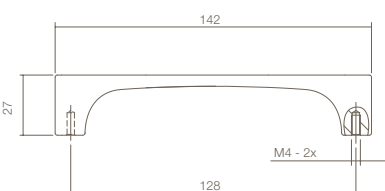
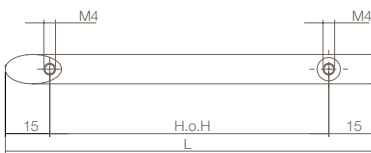
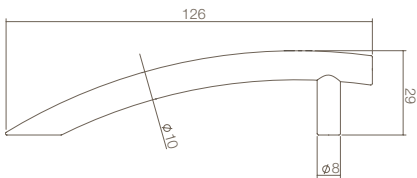
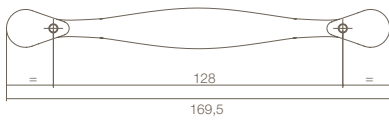
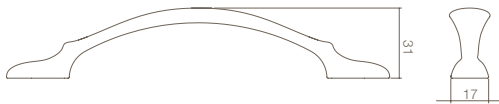
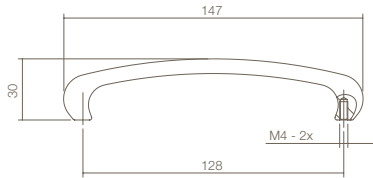

0016.875370
0016.875371
0016.875372

L	H.o.H	H
130	96mm	29
162	128mm	31
274	224mm	32



875340

0016.875340 Greep Dianne 128mm. Chrom.



Grip model Dianne 128mm. Chrome.

Möbelgriff Dianne 128mm. Chrom.

Poignée de meuble Dianne 128mm. Chromé



875360

0016.875360 Greep Mats 128mm. Chrom.



Grip model Mats 128mm. Chrome.

Möbelgriff Mats 128mm. Chrom.

Poignée de meuble Mats 128mm. Chromé.



875370

0016.875370 Greep half gebogen ø10mm. Chrom.



Handle bended ø10mm. Chrome.

Möbelgriff ø10mm. Chrom.

Poignée de meuble demi courbe ø10mm. Chromé.



875390

0016.875390 Greep Esmay 128mm. Chrom.



Grip Esmay 128mm. Chrome.

Möbelgriff Esmay 128mm. Chrom.

Poignée de meuble Esmay 128mm. Chromé.

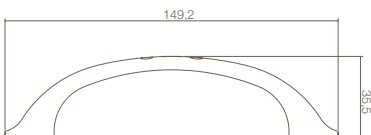
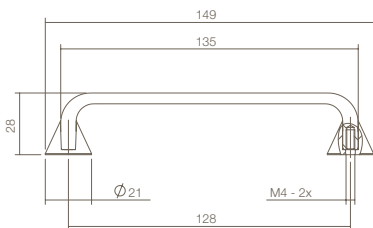
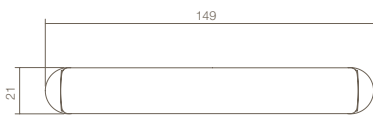
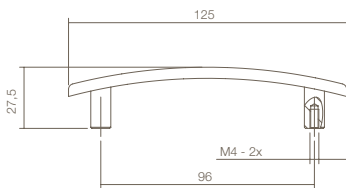
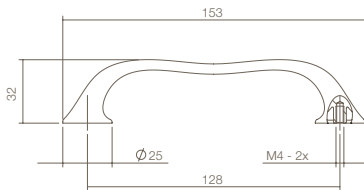
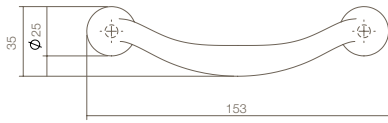

875400

0016.875400

Greep Demy 128mm. Chromom.



Grip Demy 128mm. Chrome.

Möbelgriff Demy 128mm. Chrom.

Poignée de meuble Demy 128mm. Chromé.



875410

0016.875410

Greep Rona 96mm. Chromom.



Grip Rona 96mm. Chrome.

Möbelgriff Rona 96mm. Chrom.

Poignée de meuble Rona 96mm. Chromé.



875430

0016.875430

Greep Ruben 128mm. Chromom.



Grip Ruben 128mm. Chrome.

Möbelgriff Ruben 128mm. Chrom.

Poignée de meuble Ruben 128mm. Chromé.



875440

0016.875440

Greep Anna 128mm. Chromom.



Grip model Anna 128mm. Chrome.

Möbelgriff Anna 128mm. Chrom.

Poignée de meuble Anna 128mm. Chromé.

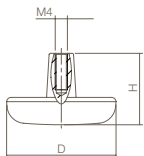
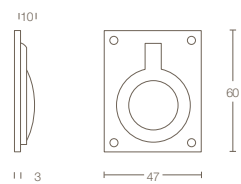
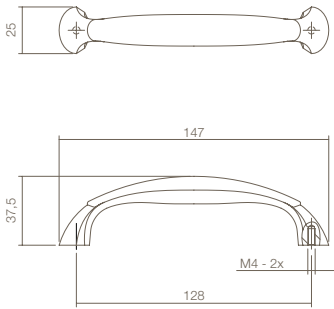

0016.847600
0016.847601

D	H
28mm	22mm
36mm	23,5mm

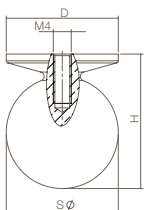

0016.847661
0016.847662
0016.847663
0016.847664

S	D	H
20mm	20mm	25mm
25mm	23,25mm	30mm
30mm	30mm	36,25mm
35mm	35mm	41mm



875460

0016.875460

Grep Lars 128mm. Chrom.



Grip Lars 128mm. Chrome.

Möbelgriff Lars 128mm. Chrom.

Poignée de meuble Lars 128mm. Chromé.



752530

0016.752530

Luikring recht 60x47mm. Chrom.



Hatch ring 60x47mm. Chrome.

Lukening 60x47mm. Chrom.

Anneau pour trappe rectangulaire
60x47mm. Chromé.

847600

0016.847600

Knop plat. Chrom.



Flat knob. Chrome.

Knopf flach. Chrom.

Bouton de meuble plat. Chromé.



847661

0016.847661

Knop bolrond. Chrome.



Knob round. Chrome.

Knopf Rund. Chrom

Bouton de meuble boule avec rosace fixe.
Chromé.

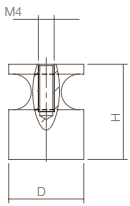

	D	H
0016.847700	16mm	20mm
0016.847701	19mm	24mm
0016.847702	25mm	32,5mm



847700

0016.847700

Knop recht. Chroom.



Handle straight. Chrome.

Möbelgriff Recht. Chrom.

Bouton de meuble droite avec rosace fixe. Chromé.

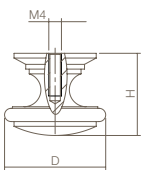

	D	H
0016.847771	21mm	20,5mm
0016.847773	32mm	26mm
0016.847774	40mm	30mm



847771

0016.847771

Knop afgerond. Chroom.



Rounded knob. Chrome.

Möbelgriff abgerund. Chrom

Bouton de meuble arrondi. Chromé.

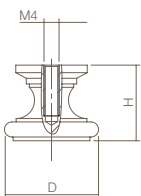

	D	H
0016.847801	20mm	16,5mm
0016.847802	25mm	20mm
0016.847803	32mm	23,5mm



847801

0016.847801

Knop plat. Chroom.



Flat knob. Chrome.

Knopf flach. Chrom.

Bouton de meuble plat. Chromé.

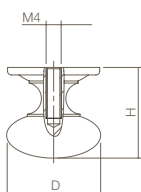

	D	H
0016.847821	25mm	24mm
0016.847822	30mm	28,5mm
0016.847823	35mm	33mm



847821

0016.847821

Knop paddenstoel met achterplaat. Chroom.



Knob mushroom with backplate. Chrome.

Knopf Pilz mit Rückenplatte. Chrom

Bouton de meuble Champignon avec rosace fixe. Chromé.





Chroom - Chrome - Chrom - Chromé

Toebehoren - Garderobe

0016

Accessories - Coat rack

Zubehör - Garderoben

Accessoires - Porte-manteaux



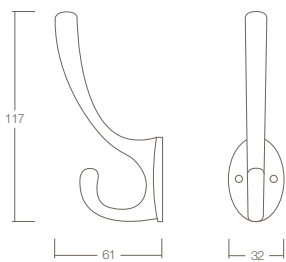
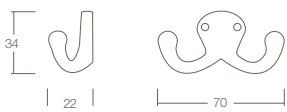
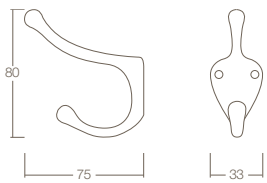
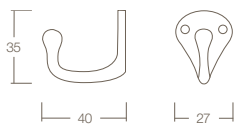
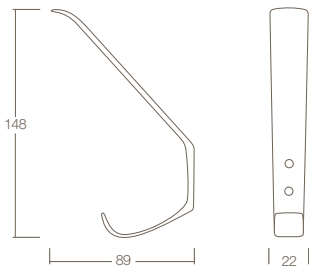

6926

0016.692600

Kapstokhaak 150mm. Chroom.



Hat & coat hook 150mm. Chrome.

Kleiderhaken 150mm. Chrom.

Crochet porte-manteaux 150mm. Chromé.



6926

0016.692611

Jashaak scheepsmodel. Chroom.



Coat hook. Chrome.

Mantelhaken. Chrom.

Crochet modèle bateau simple. Chromé.



6926

0016.692612

Kapstokhaak scheepsmodel lang. Chroom.



Hat & coat hook. Chrome.

Kleiderhaken. Chrom.

Crochet porte-manteau modèle bateau. Chromé.



6926

0016.692613

Kapstokhaak scheepsmodel dubbel. Chroom.



Hat & coat hook. Chrome.

Kleiderhaken. Chrom.

Crochet modèle bateau double. Chromé.



6926

0016.692620

Kapstokhaak ovaal. Chroom.



Hat & coat hook oval. Chrome.

Kleiderhaken Oval. Chrom.

Crochet porte-manteau modèle ovale. Chromé.





Chroom - Chrome - Chrom - Chromé

Toebehoren - Leuninghouders

0016

Accessories - Handrail brackets

Zubehör - Handlaufstützen

Accessoires - Supports de rampe



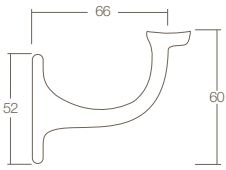

0016.724520



724520

0016.724520

Leuninghouder met schroefgaten. Vlak zadel. Chromo.



Handrail bracket screw mounting. Flat saddle. Chrome.

Handlaufstütze schraubbar. Flach Sattel. Chrom.

Support de rampe. Plaque avec trous de vis. Selle plate. Chromé.

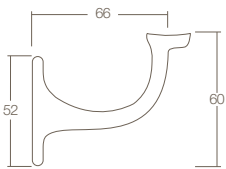

0016.724521



724521

0016.724521

Leuninghouder met schroefgaten. Hol zadel. Chromo.



Handrail bracket screw mounting. Hollow saddle. Chrome.

Handlaufstütze, schraubbar. Hohl Sattel. Chrom.

Support de rampe. Plaque avec trous de vis. Selle creuse. Chromé.

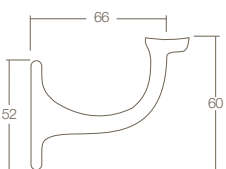

0016.724540



M8



724540

0016.724540

Leuninghouder centraal M8. Vlak zadel. Blinde montage. Chromo. Incl. bevestigingsmateriaal.



Handrail bracket M8. Flat saddle. Chrome. Fixing materials included.

Handlaufstütze M8. Flach Sattel. Chrom. inkl. Befestigungsmaterial.

Support de rampe avec petite plaque. Taraudé M8. Selle plate. Chromé. Fixations fournies.

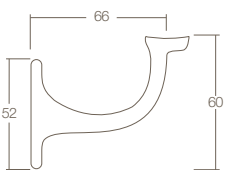

0016.724541



M8



724541

0023.724541

Leuninghouder centraal M8. Hol zadel. Blinde montage. Chromo. Incl. bevestigingsmateriaal.



Handrail bracket M8. Hollow saddle. Chrome. Fixing materials included.

Handlaufstütze M8. Hohl Sattel. Chrom. inkl. Befestigungsmaterial.

Support de rampe avec petite plaque. Taraudé M8. Selle creuse. Chromé. Fixations fournies.

Chroom - Chrome - Chrom - Chromé

Toebehoren - Deurspionnen

0016

Accessories - Doorviewers

Zubehör - Türspionen

Accessoires - Judas de porte

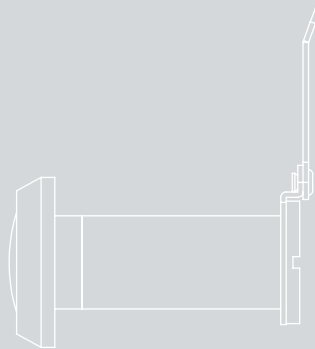

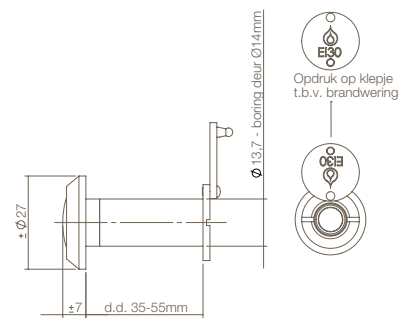
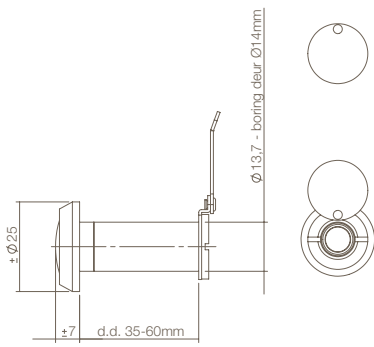

Opdruk op klepje
t.b.v. brandwering

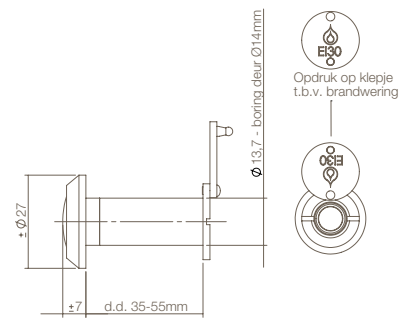

Opdruk op klepje
t.b.v. brandwering



405530

0016.405530 Deurspion 180° Chromom.



Door viewer 180° Chrome.



Türspione 180° chrom.

Judas optique. Angle de vision 180°. Chromé.

Ø 14mm



405531

0016.405531 Deurspion 200° Chromom. 30 min. brandwerend.



Door viewer 200° Chrome. 30 min. fire proof.



Türspione 200° chrom. 30 min. feuerfest.



Judas optique. Angle de vision 200°. Coupe-feu 30 min. Chromé.

Ø 14mm



405532

0016.405532 Deurspion 200° Chromom. 60 min. brandwerend.



Door viewer 200° Chrome. 60 min. fire proof.



Türspione 200° chrom. 60 min. feuerfest.



Judas optique. Angle de vision 200°. Coupe-feu 60 min. Chromé.

Ø 14mm

Nikkel - Nickel - Vernickelt - Nicklé

Binnendeurbeslag - Losse krukken

0018

Interior door hardware - Door handles

Innentürbeschläge - Türdrucker

Garnitures de porte intérieure - Béquilles

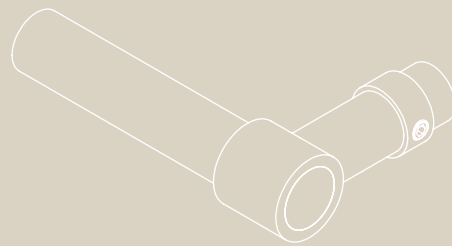

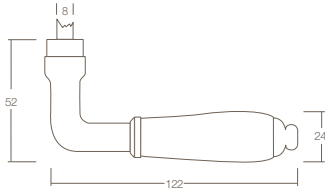
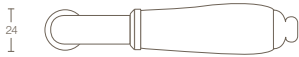

0018.020600

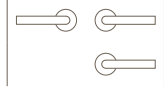

0018.020600A

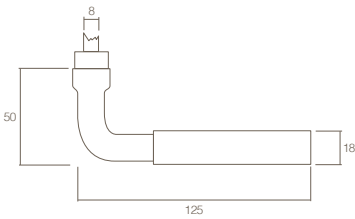

0018.021700

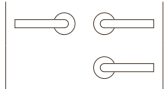

0018.021700A

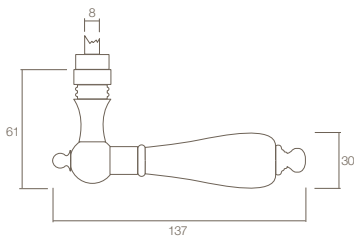

0018.031800

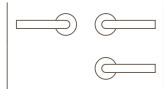

0018.031800A



0206

0018.020600 Deurkruk Courgette. Nikkel/zwart.

Door handle Courgette.
Nickel/black.Türdrücker Courgette. Vernickelt/Schwarz.
Béquille Courgette. Nicklé/noir.

0217

0018.021700 Deurkruk Palma. Nikkel/zwart.

Door handle Palma.
Nickel/black.Türdrücker Palma. Vernickelt/Schwarz.
Béquille Palma. Nicklé/noir.

0318

0018.031800 Deurkruk Peer zwaar. Nikkel/porselein.



Door handle Pear. Nickel/porcelain.

Türdrücker Birne. Vernickelt/Porzellan.
Béquille Poire. Nicklé/porcelaine.

Accessoires

Accessories
Zubehör

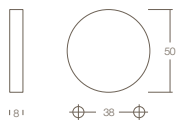

0018.315604



0018.315616



0018.315617



0018.315660



8mm



0018.370557

5mm

0018.370660

8mm verlengd

38 - 42

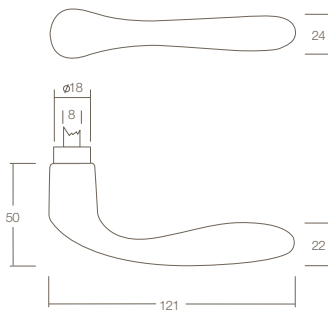

0018.020100

0018.020100A

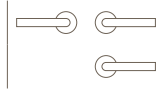

0201

0018.020100

Deurkruk Banaan. Nikkel.

Door handle Banana. Nickel.

Türdrücker Banane. Vernickelt.

Béquille Banane. Nicklé.

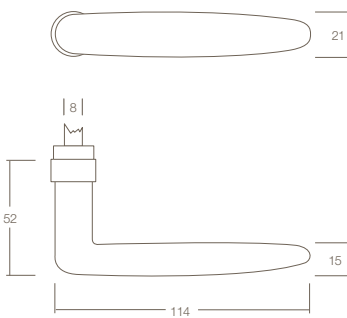

0018.022500

0018.022500A

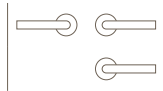

0225

0018.022500

Deurkruk Sophie. Nikkel.

Door handle Sophie. Nickel.

Türdrücker Sophie. Vernickelt.

Béquille Sophie. Nicklé.

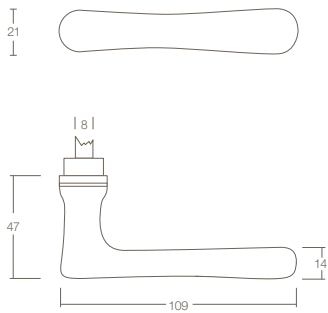

0018.038800

0018.038800A

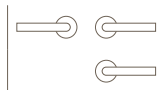

0388

0018.038800

Deurkruk Trento. Nikkel.

Door handle Trento. Nickel.

Türdrücker Trento. Vernickelt.

Béquille Trento. Nicklé.



Accessoires
Accessories
Zubehör

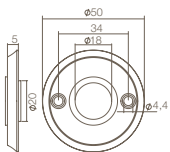

0018.317304



0018.317316



0018.317317



0018.317360



8mm



0018.370560

8mm

0018.370660

8mm verlengd



0018.322004

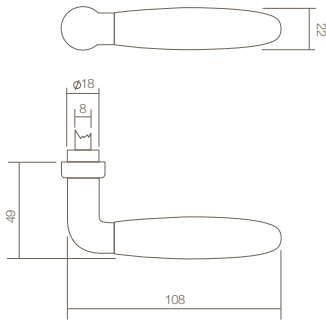

0018.022200

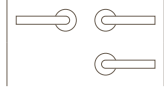

0018.022200A



0222

0018.022200

Deurkruk Tessa. Nikkel/zwart hout.



Door handle Tessa. Nickel polished/black wood.



Türdrücker Tessa. Vernickelt/Schwarzes Holz.

Béquille Tessa. Nicklé/bois noir.

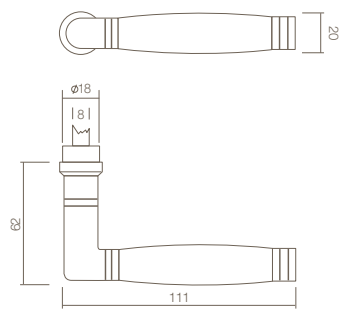

0018.037500

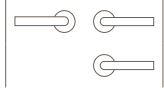

0018.037500A



0375

0018.037500

Deurkruk Ton 222. Nikkel/ebbenhout.



Door handle Ton 222. Nickel/ebony.



Türdrücker Ton 222. Vernickelt/Ebenholz.

Béquille Ton 222. Nicklé/bois d'ébène.

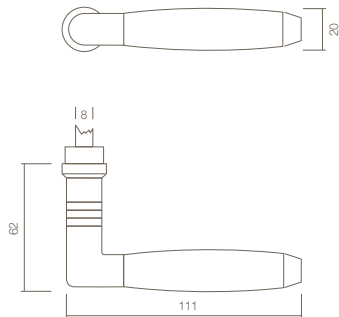

0018.037700

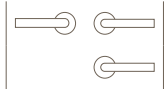

0018.037700A



0377

0018.037700

Deurkruk Ton 400. Nikkel/ebbenhout.



Door handle Ton 400. Nickel/ebony.



Türdrücker Ton 400. Vernickelt/Ebenholz.

Béquille Ton 400. Nicklé/bois d'ébène.

Accessoires

Accessories
Zubehör

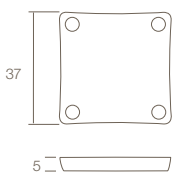

0018.318316



0018.318317



0018.318360

8mm



0018.322004



0018.370960

8mm



0018.318304



0018.370002



0018.370001



0018.257111

0018.257011

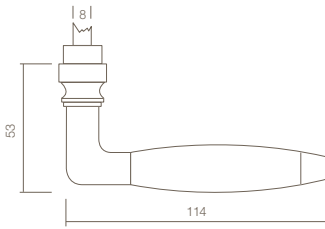

0018.037100

0018.037100A

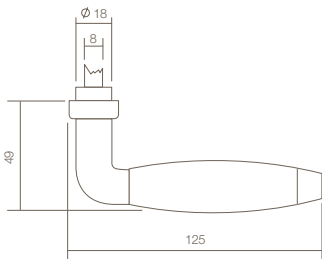
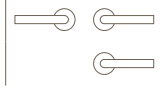

0018.042000

0018.042000A

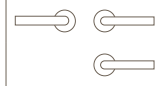

0371

0018.037100

Deurkruk Marloes. nikkel/ebbenhout.

Door handle Marloes. Nickel/ebony.

Türdrücker Marloes. Vernickelt/Ebenholz.

Béquille modèle Marloes. Nicklé/bois d'ébène.



0420

0018.042000

Deurkruk Antonnet. Nikkel/ebbenhout.

Door handle Antonnet. Nickel/ebony

Türdrücker Antonnet. Vernickelt/Ebenholz

Béquille modèle Antonnet. Nicklé/bois d'ébène.



Accessoires Accessories Zubehör

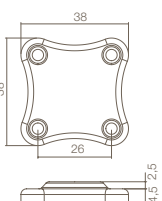

0018.318904



0018.318916



0018.318960

8mm



0018.322004



0018.371060

8mm



0018.370002



0018.370101



0018.257111



0018.257011

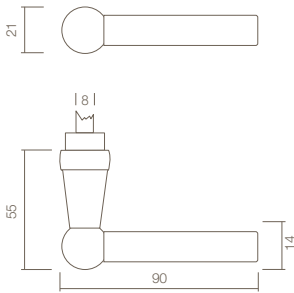

0018.032300		L+L
0018.032300A		L



0323

- 0018.032300** Deurkruk L/L-model. Nikkel.
 Door handle L/L-model. Nickel.
 Türdrücker L/L-model. Vernickelt.
 Béquille modèle L/L. Nicklé.

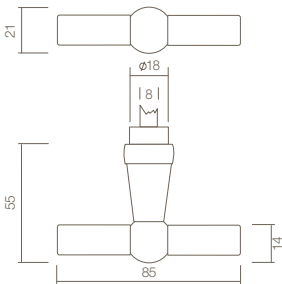

0018.032400		L+T
0018.032400A		T



0324

- 0018.032400** Deurkruk L/T-model. Nikkel.
 Door handle L/T-model. Nickel.
 Türdrücker L/T-Model. Vernickelt.
 Béquille modèle L/T. Nicklé.

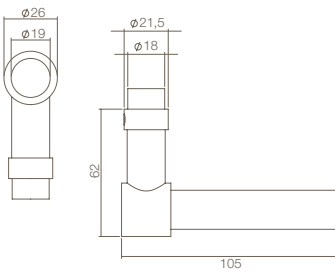

0018.046000		L+L
0018.046000A		L



0460

- 0018.046000** Deurkruk L/L-model. Rech. Nikkel.
 Door handle L/L-model. Straight. Nickel.
 Türdrücker L/L-Modell. Rech. Vernickelt.
 Béquille modèle L/L. Droit. Nicklé.

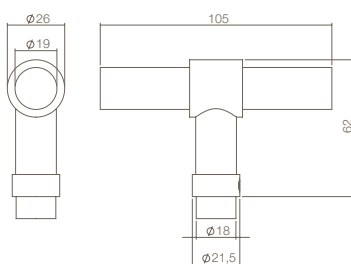

0018.046100		L+T
0018.046100A		T



0461

- 0018.046100** Deurkruk L/T-model. Rech. Nikkel.
 Door handle L/T-model straight. Nickel polished.
 Türdrücker L/T Modell Rech. Vernickelt.
 Béquille modèle L/T droit. Nicklé.



Accessoires Accessories Zubehör

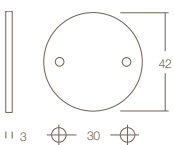

0018.318504



0018.318516



0018.318517



0018.318560



8mm



0018.370960



8mm



0018.258011

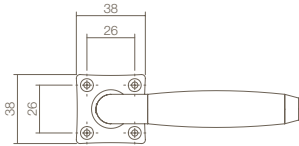
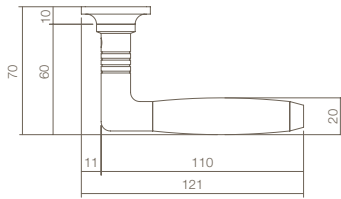

0018.037802

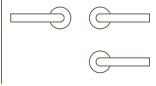

0018.037802A



0378

0018.037802

Deurkruk Ton Basic incl. rozet. Nikkel.



Lever Ton Basic incl. rose. Nickel.



Türdrücker Ton Basic inkl. Rosette. Vernickelt.

Béquille modèle Ton Basic avec rosace. Nicklé.

Accessoires

Accessories
Zubehör



0018.318316



0018.318317



0018.318360

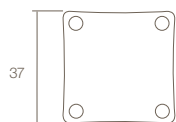



Nikkel - Nickel - Vernickelt - Nicklé

Binnendeurbeslag - Schilden

0018

Interior door hardware - Plates

Innentürbeschläge - Schilder

Garnitures de portes intérieure - Plaqués

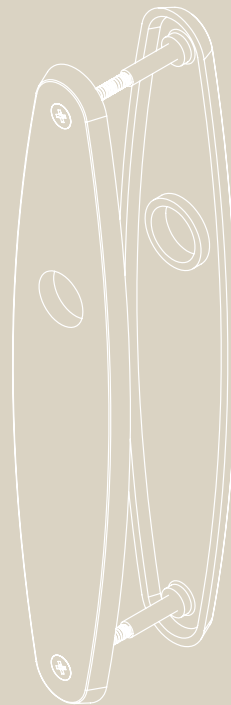

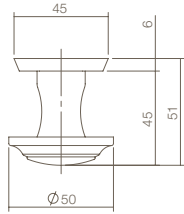
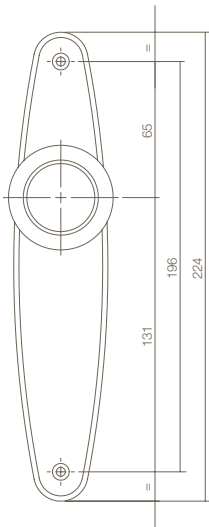

0018.253111		-----	
0018.253124			56mm
0018.253126			72mm
0018.253129			55mm
0018.253136			72mm



2531

0018.253111

Knopschild ellips. Nikkel.



Knob on plate ellipse. Nickel.

Knopf auf Schild Ellipse. Vernickelt.

Bouton fixe sur plaque Ellipse. Nicklé.

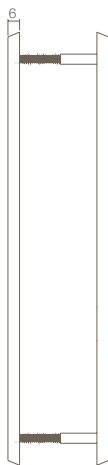
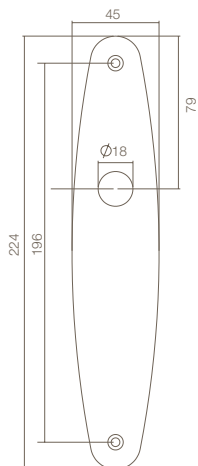

0018.258011			-----	
0018.258024				56mm
0018.258026				72mm
0018.258029				55mm
0018.258036				72mm
0018.258062				WC 55/8
0018.258063				WC 57/5
0018.258065				WC 63/8

Optie: Te combineren met deurkrukken op pagina 114 - 118.

Option: Combine with doorhandles from page 114 - 118.

Option: Zu kombinieren mit Türdrücker auf Seite 114 - 118.

Option: Une combinaison possible avec les béquilles de la page 114 - 118.



2580

0018.258011

Schild ellips. Nikkel.



Plate ellipse. Nickel.

Schild Ellipse. Vernickelt.

Plaque Ellipse. Nicklé.









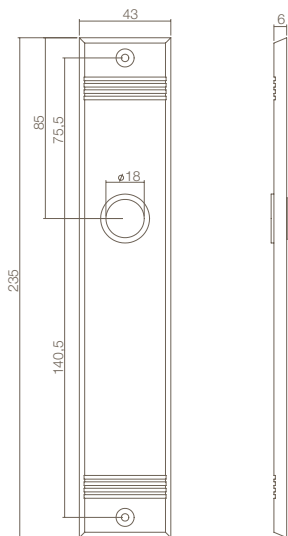
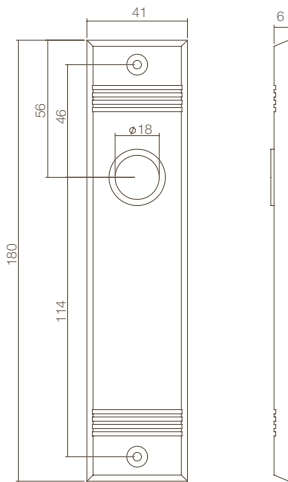

















Accessoires

Accessories
Zubehör



0099.975343	M14		≤ 42
0099.975363	M14		≤ 60
0099.975364	M14		≤ 90





























0018.257011				---	
0018.257024				56mm	
0018.257026				72mm	
0018.257029				55mm	
0018.257036				72mm	
0018.257062				WC 55/8	
0018.257063				WC 57/5	
0018.257065				WC 63/8	
0018.257067				WC 72/8	

Optie: Te combineren met deurkrukken op pagina 114 - 118.

Option: Combine with doorhandles from page 114 - 118.

Option: Zu kombinieren mit Türdrücker auf Seite 114 - 118.

Option: Une combinaison possible avec les béquilles de la page 114 - 118.

0018.257111				---	
0018.257124				56mm	
0018.257126				72mm	
0018.257129				55mm	
0018.257136				72mm	
0018.257162				WC 55/8	
0018.257163				WC 57/5	
0018.257165				WC 63/8	
0018.257167				WC 72/8	

Optie: Te combineren met deurkrukken op pagina 114 - 118.

Option: Combine with doorhandles from page 114 - 118.

Option: Zu kombinieren mit Türdrücker auf Seite 114 - 118.

Option: Une combinaison possible avec les béquilles de la page 114 - 118.



0018.257011

Kortschild met groef. Nikkel.



Short plate straight with chamfer. Nickel.



Kurzchild mit Furche. Vernickelt.



Plaque courte avec rainures. Nicklé.

2570



0018.257111

Langschild recht met groef. Nikkel.



Long plate straight with chamfer. Nickel.









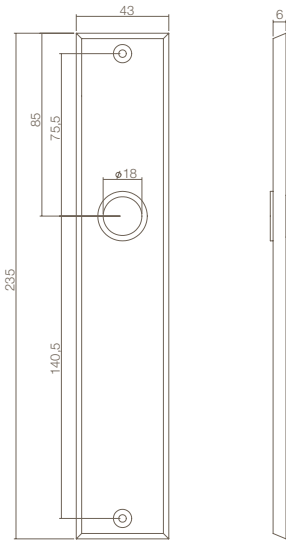

Langschild recht. Mit Furche. Vernickelt.



Plaque longue rectangulaire avec rainures. Nicklé.

2571



0018.257711	-----
0018.257724	 56mm
0018.257726	 72mm
0018.257729	 55mm
0018.257736	 72mm
0018.257762	 55/8mm
0018.257763	 57/5mm
0018.257765	 63/8mm
0018.257767	 72/8mm

Optie: Te combineren met deurkrukken op pagina 114 - 118.

Option: Combine with doorhandles from page 114 - 118.

Option: Zu kombinieren mit Türdrücker auf Seite 114 - 118.

Option: Une combinaison possible avec les béquilles de la page 114 - 118.

**0018.257711**

Renovatie langschild rechthoekig, voor krukken met krukhalshals \varnothing 18mm. Nikkel. 235mm x 43mm x 6mm.



Renovationplate. For door handles with insert \varnothing 18mm. Nickel. 235mm x 43mm x 6mm.



Renovationslangschild eckig. Für Türdrücker mit Drücker Hals \varnothing 18mm. Vernickelt. 235mm x 43mm x 6mm.

Plaque de renovation longue rectangulaire. Pour l'usage des béquilles avec cou de \varnothing 18mm. Nickelé. 235mm x 43mm x 6mm.

Nikkel - Nickel - Vernickelt - Nicklé

Binnendeurbeslag, vastdraaibaar - Vierkant

0018

Interior door hardware, springloaded - Square

Innentürbeschläge, Festdrehbar - Eckig

Garnitures de portes intérieure, avec ressort - Carrée

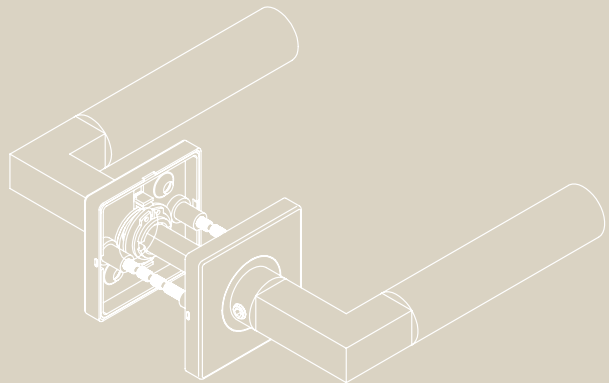

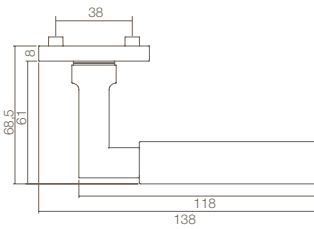
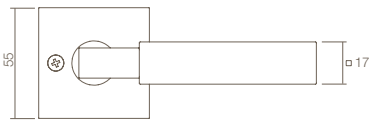

0018.038202



0018.038202A



0018.038202B



0382

0018.038202

Deurkruk Bau-Stil vastdraaibaar met veer op vierkant rozet. Nikkel/ebbenhout.



Springloaded door handle Bau-Stil on square rose. Nickel/ebony.



Türdrücker Bau-Stil festdrehbar gelagert mit Feder auf eckiger Rosette. Vernickelt/Ebenholz.



Béquille Bau-Stil sertie sur rosace carrée, avec ressort. Nickelé/bois d'ébène.

Accessoires

Accessories
Zubehör

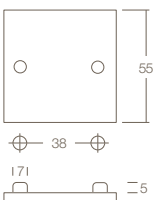

0018.318416



0018.318417



0018.318460



0018.371059

7mm 

0018.371060

8mm 

Nikkel - Nickel - Vernickelt - Nicklé

Buitendeurbeslag - Rond / Ovaal

0018

Exterior door hardware - Round / Oval

Außentürbeschläge - Rund / Oval

Garnitures de portes à l'extérieure - Rond / Ovale



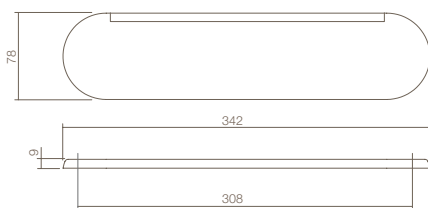
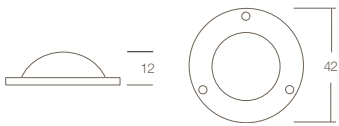

3975



0018.397500 Afdeekplaatje t.b.v. bout. Nikkel.



Bolt cover plate. Nickel.

Abdeckplatte für Bolzen. Vernickelt.

Ce cache boulon couvre la vis du bouton.
Nicklé.

4015



0018.401500 Tochtwering ovaal met borstel en afdekklep verdekt. Nikkel.



Oval draught flap with brush and rain edge.
Nickel.

Zugklappe oval mit Bürstenleiste und
Abdeckklappe verdeckt. Vernickelt.

Plaque-à-lettres anti courants d'air,
ovale, avec clapet. Nicklé.

Let op: Briefplaat buiten in nikkel is vanwege weersinvloeden niet mogelijk.

Attention: Outside letterplate nickel is not possible due to weather conditions.

Achtung: Briefeinwurf in Nickel ist nicht möglich aufgrund von Witterungseinflüssen.

Option: Une plaque à lettres anti courants d'air nicklé montée à l'extérieur n'est pas possible en raison des intempéries.

Nikkel - Nickel - Vernickelt - Nicklé

Buitendeurbeslag - Vierkant

0018

Exterior door hardware - Square

Außentürbeschläge - Eckig

Garnitures de portes extérieure - Carrée

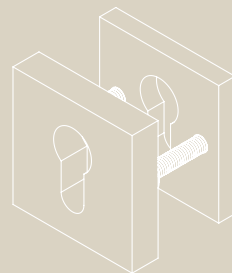

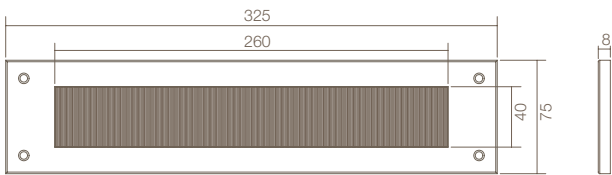

4015



0018.401503 Tochtwering rechthoek. Nikkel.



Draught flap square. Nickel.

Zugklappe rechthoekig. Vernickelt.

Plaque-à-lettres rectangulaire, anti courants d'air. Nicklé.

Let op: Briefplaat buiten in nikkel is vanwege weersinvloeden niet mogelijk.

Attention: Outside letterplate nickel is not possible due to weather conditions.

Achtung: Briefeinwurf in Nickel ist nicht möglich aufgrund von Witterungseinflüssen.

Option: Une plaque à lettres anti courants d'air nicklé montée à l'extérieur n'est pas possible en raison des intempéries.

Nikkel - Nickel - Vernickelt - Nicklé

Raambeslag - Raamsluitingen

0018

Window fittings - Window closers

Fensterbeschläge - Fenstersicherung

Garnitures de fenêtres - Béquille de fenêtre

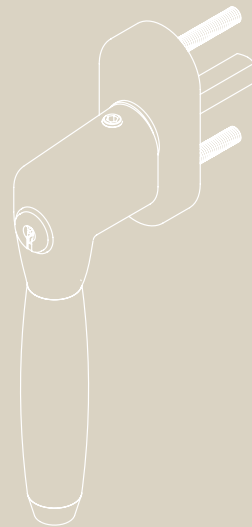

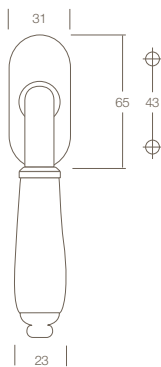
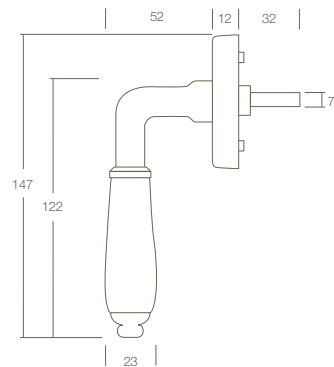
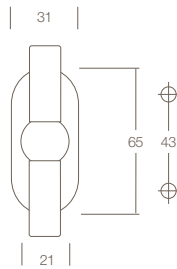
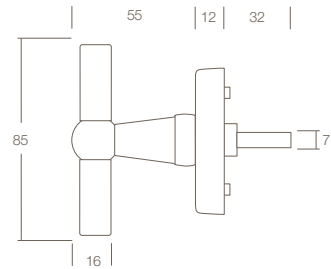
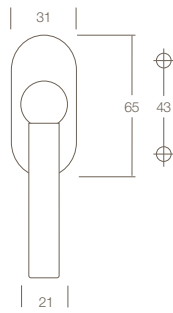
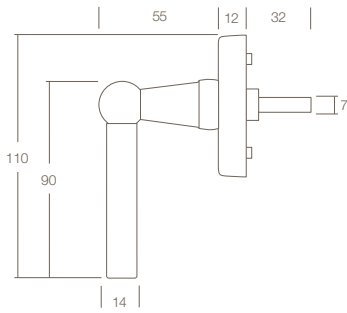

6050

0018.605011

Raamkruk L-model. Nikkel.



Window handle L-model. Nickel.

Fenstergriff L-Modell. Vernickelt.

Béquille de fenêtre modèle L. Nicklé.



6050

0018.605013

Raamkruk T-model. Nikkel.



Window handle T-model. Nickel.

Fenstergriff T-Modell. Vernickelt.

Béquille de fenêtre modèle T. Nicklé.



6050

0018.605070

Raamkruk Courgette. Nikkel/zwart.



Window handle Courgette. Nickel/black.

Fenstergriff Courgette Vernickelt/Schwarz.

Béquille de fenêtre modèle Courgette. Nicklé/noir.

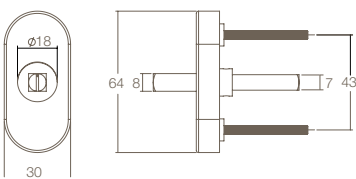
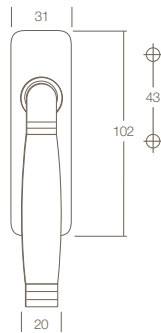
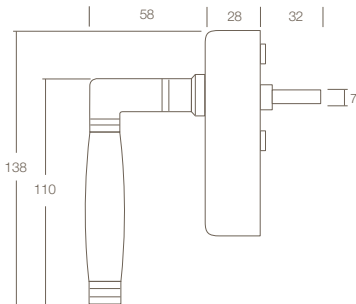
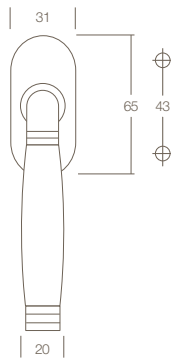
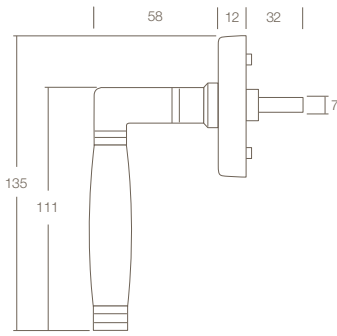

6051

0018.605190

Raamkruk Ton 222. Nikkel/ebbenhout.



Window handle Ton 222. Nickel/ebony.

Fenstergriff Ton 222. Vernickelt/Ebenholz.

Béquille de fenêtre Ton 222. Nicklé/bois d'ébène.



6616

0018.661640

Raamkruk Ton 222. afsluitbaar. Nikkel/ebbenhout.



Lockable window handle Ton 222. Nickel/ebony.

Fenstergriff Ton 222. Abschließbar. Vernickelt/Ebenholz.

Béquille de fenêtre modèle Ton 222. Verrouillable. Nicklé/bois d'ébène.



6050

0018.605000

Onderconstructie tbv. raamkruk met hals ø18mm. Nikkel.



Baseplate for window handle with a ø18mm insert. Nickel.

Unterkonstruktion für Fenstergriffe mit ø18mm Drückerhals. Vernickelt.

Sous-construction pour béquille de fenêtre cou ø18mm. Nicklé.

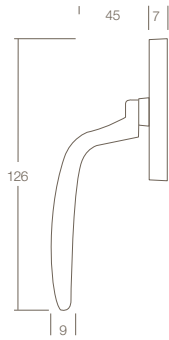
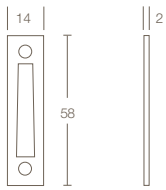

0018.561550A

0018.561550B

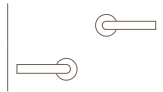

561550

0018.561550A

Raamsluiting Dudok, rechts. Nikkel.



Window closer Dudok, right. Nickel.

Fenstersicherung Dudok, rechts. Vernickelt.

Crémone modèle Dudok, droite. Nicklé.

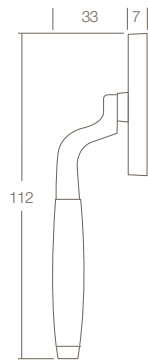
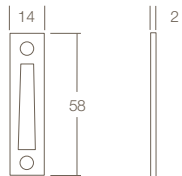

0018.561560A

0018.561560B

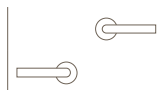

561560

0018.561560A

Raamsluiting, rechts. Nikkel/zwart hout.



Window closer, right. Nickel/black wood.

Fenstersicherung, rechts. Vernickelt/Schwarzes Holz.

Crémone, droite. Nicklé/bois noir.

Accessoires

Accessories
Zubehör



0018.561540

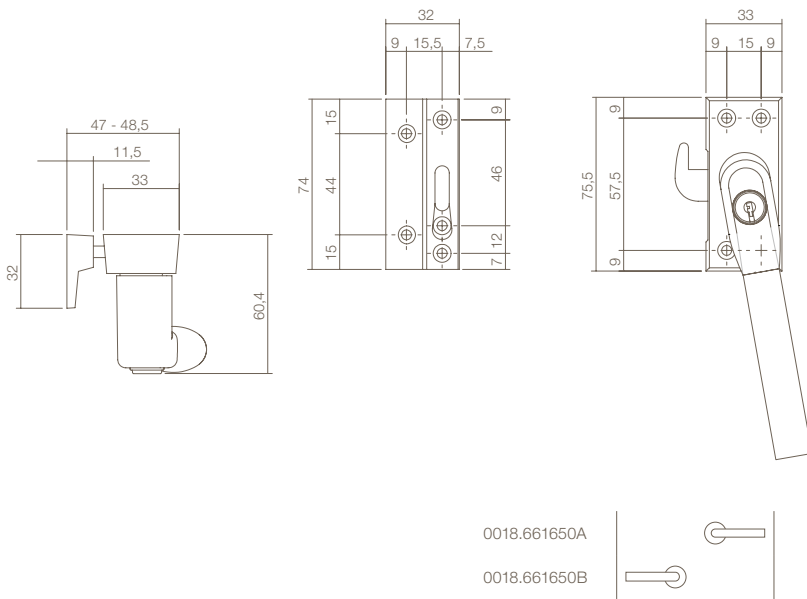

661650

0018.661650A Afsluitbare raamsluiting recht, rechts. Compleet. Nikkel.



Lockable window closer straight, right. Complete. Nikkel.



Fenstersicherung. Abschließbar. Recht. Komplett. Vernickelt.

Béquille de fenêtre verrouillable. Modèle droite. Complet. Nickelé.

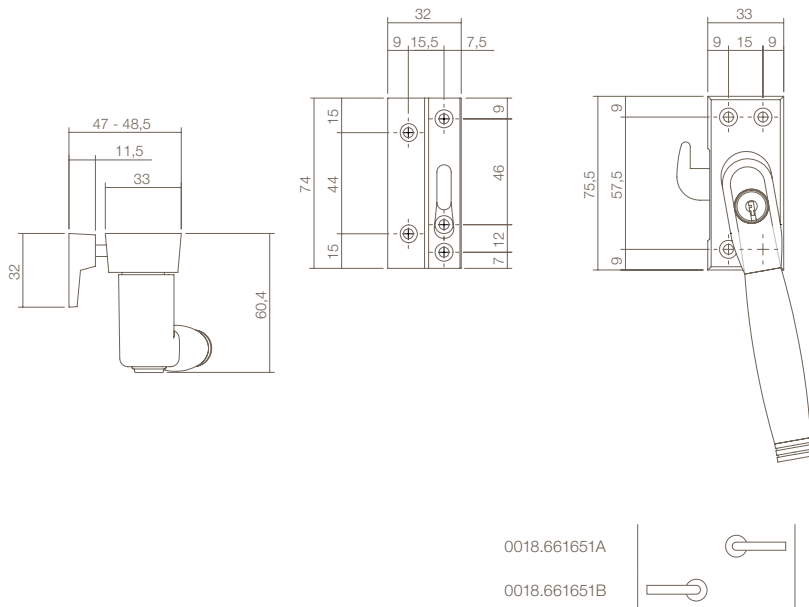

661651

0018.661651A Afsluitbare raamsluiting Ton 222, rechts. Compleet. Nikkel/ebbenhout.



Lockable window closer Ton 222, right. Complete. Nikkel/ebony.



Fenstersicherung. Abschließbar Ton 222, rechts. Komplett. Vernickelt/Ebenholz.

Béquille de fenêtre verrouillable. Modèle Ton 222, droite. Complet. Nickelé/bois d'ébène.

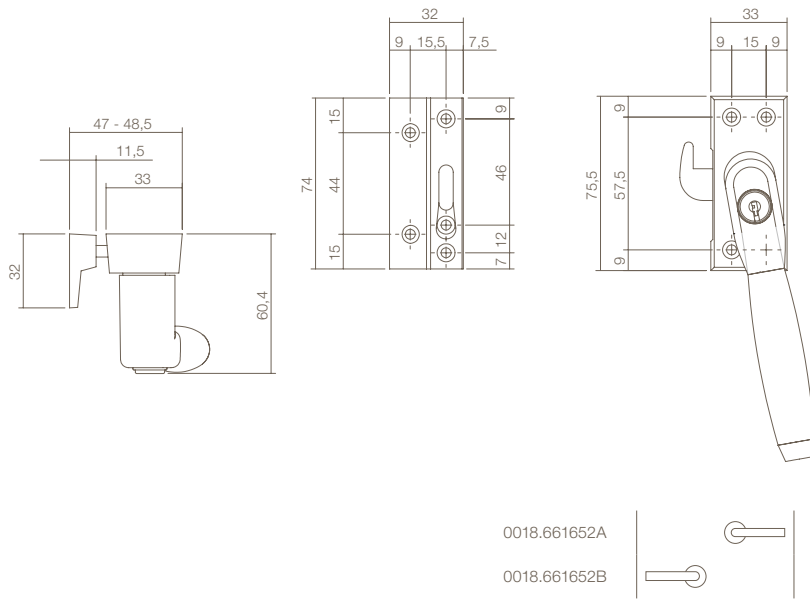

661652



0018.661652A Afsluitbare raamsluiting Ton 400, rechts. Compleet. Nikkel/ebbenhout.



Lockable window closer Ton 400, right. Complete. Nickel/ebony.



Fenstersicherung. Abschließbar. Ton 400, rechts. Komplett. Vernickelt/Ebenholz.

Béquille de fenêtre verrouillable. Modèle Ton 400, droite. Complet. Nickelé/bois d'ébène.

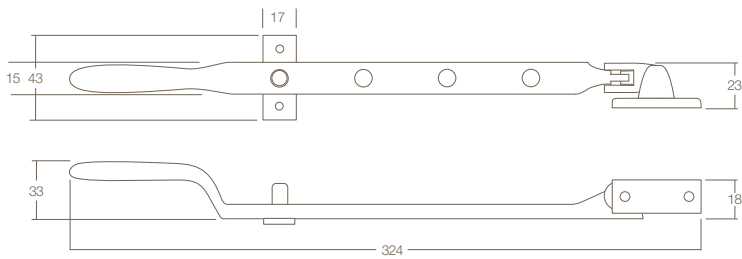
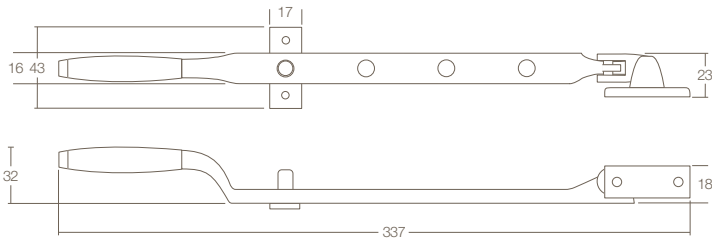

561580



0018.561580 Raamuitzetter Dudok met stelpen.Nikkel.



Window expander Dudok. Nickel.

Fensteraufsteller Dudok. Vernickelt.

Entrebâilleur Dudok avec cheville de positionnement. Nicklé.

561581



0018.561581 Raamuitzetter met stelpen. Nikkel/zwart hout.



Window expander. Nickel/black wood.

Fensteraufsteller. Vernickelt/Schwarzes Holz.

Entrebâilleur avec cheville de positionnement. Nicklé/bois noir.

Accessoires

Accessories
Zubehör



0018.561589

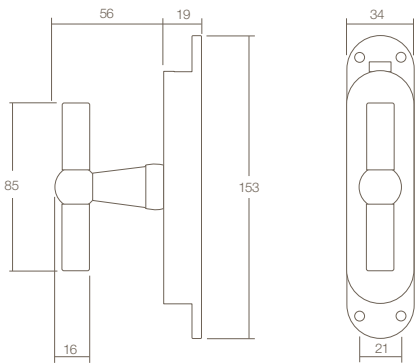

562020

0018.562020

Espagnolet T-kruk. Nikkel.



Espagnolette T-handle. Nickel.

Espagnolette T-Griff. Vernickelt.

Crémone kit "T". Nicklé.

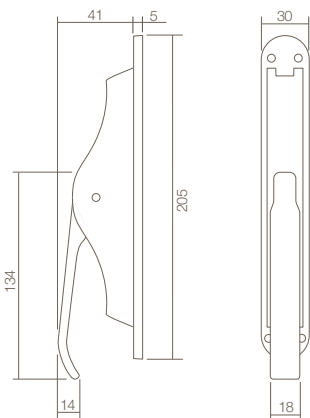

562030

0018.562030

Pomp-espagnolet. Nikkel.



Espagnolette. Nickel.

Espagnolette. Vernickelt.

Espagnolette à levier. Nicklé.

Accessoires

Accessories
Zubehör



0018.562000



0018.562002

0018.562004
2 x 125cm0018.562007
2 x 125cm

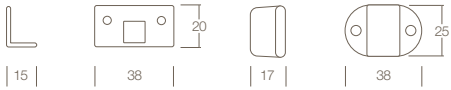
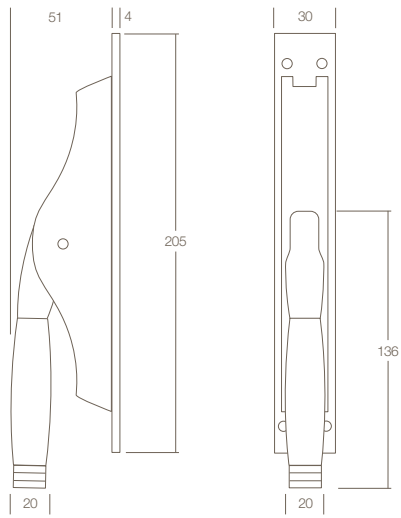

562035

0018.562035

Pomp-espagnolet Ton 222.
Nikkel/ebbenhout.Espagnolette Ton 222.
Nikkel/ebony.Espagnolette Ton 222.
Vernickelt/Ebenholz.Espagnolette à levier Ton 222.
Nicklé/bois d'ébène.

Accessoires

Accessories
Zubehör



0018.562000



0018.562002

0018.562004
2 x 125cm

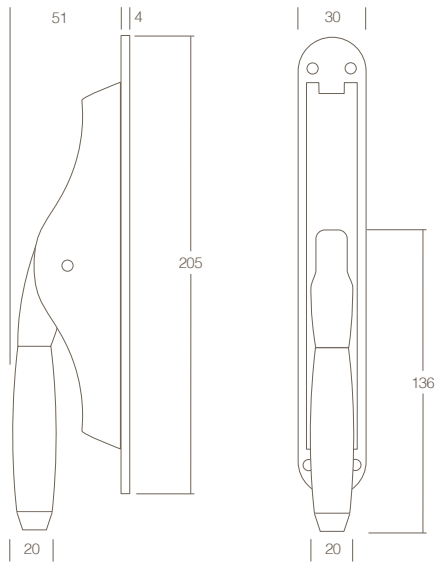

5620

0018.562036

Pomp-espagnolet Ton 400.
Nikkel/ebbenhout.



Espagnolette Ton 400.
Nikkel/ebony.

Espagnolette Ton 400.
Vernickelt/Ebenholz.

Espagnolette à levier. Ton 400.
Nicklé/bois d'ébène.

Accessoires

Accessories
Zubehör



0018.562000



0018.562002



0018.562004
2 x 125cm

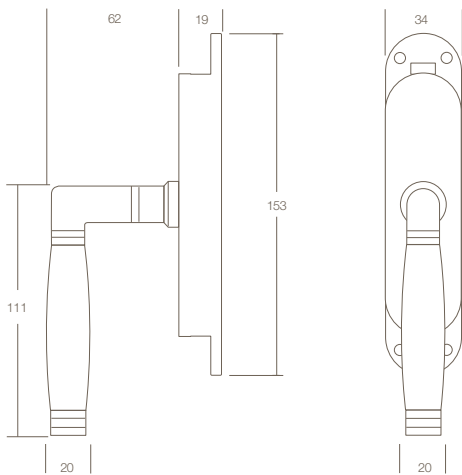

0018.562060A

0018.562060B

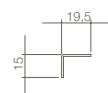
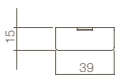
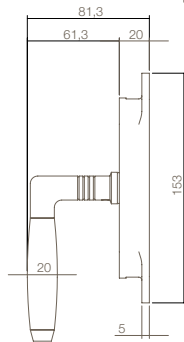
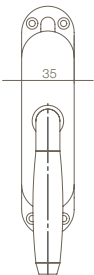
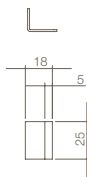
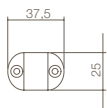
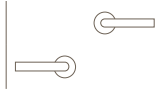

0018.562061A

0018.562061B

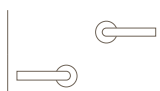

562060

0018.562060A

Kruk-espagnolet Ton 222, rechts.
Nikkel/ebbenhout.Lever-Espagnolette Ton 222, right.
Nikkel/ebony.Griff-Espagnolette Ton 222, rechts.
Vernickelt/Ebenholz.

Crémone kit Ton 222, droite. Nicklé/bois d'ébène.



562061

0018.562061A

Kruk-espagnolet Ton 400, rechts.
Nikkel/ebbenhout.Lever-Espagnolette Ton 400, right.
Nikkel/ebony.Griff-Espagnolette Ton 400, rechts.
Vernickelt/Ebenholz.

Crémone kit Ton 400, droite. Nicklé/bois d'ébène.

Accessoires

Accessories
Zubehör



0018.562000



0018.562002

0018.562007
2 x 125cm

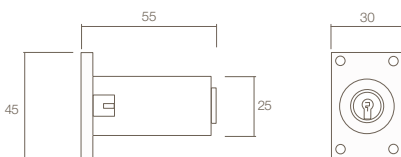
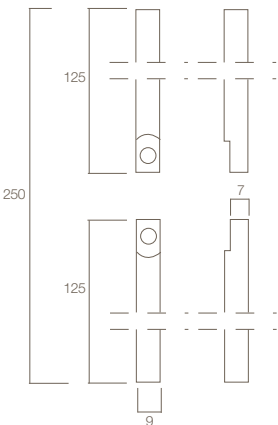
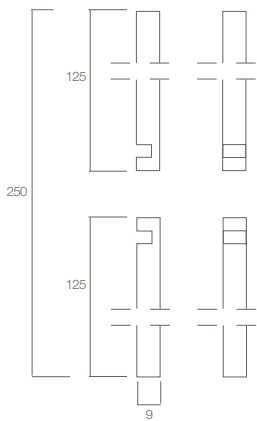

562004

0018.562004

Stangenset tbv. **pomp-espagnolet**. 2 x 125cm. Nikkel.

Rods set for espagnolette. 2 x 125cm. Nickel.

Stangen set für Espagnolette. 2 x 125cm. Vernickelt.

Set tringles pour espagnolette à levier. 2 x 125cm. Nicklé.



562007

0018.562007

Stangenset tbv. **kruk-espagnolet**. 2 x 125cm. Nikkel.

Rods set for Espagnolette. 2 x 125cm. Nickel.

Stangen set für Espagnolette. 2 x 125cm. Vernickelt.

Set tringles pour crénone. 2 x 125cm. Nicklé.



562002

0018.562002

Espagnoletslot. Nikkel.



Espagnolette lock. Nickel.

Espagnolette sperren. Vernickelt.

Verou pour espagnolette. Nicklé.

Accessoires

Accessories
Zubehör



0018.562000



0018.562001

Nikkel - Nickel - Vernickelt - Nicklé

Toebehoren - Deurstoppers

0018

Accessories - Doorstops

Zubehör - Türstopper

Accessoires - Butoirs de porte

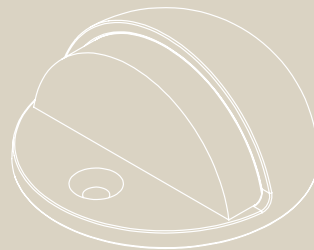

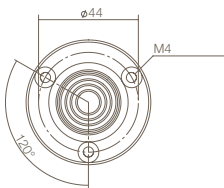
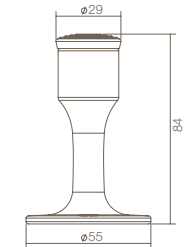
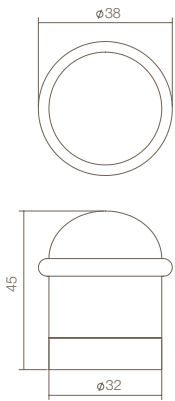

4420

0018.442000

Deurstop met ring. Nikkel.
Vloermontage.



Door stop with ring. Nickel.
Floor mounting.

Türstopper mit Ring. Vernickelt.
Bodenmontage.

Butoir de porte avec baque. Nicklé.
Pose au sol.



4420

0018.442040

Deurstop recht model. Nikkel.
Wandmontage



Door stop straight. Nickel.
Wall mounting.

Türstopper recht. Vernickelt.
Wandmontage.

Butoir de porte droit. Nicklé.
Pose mural.

Nikkel - Nickel - Vernickelt - Nicklé

Toebehoren - Deurgrepen

0018

Accessories - Pull handles

Zubehör - Stoßgriffe

Accessoires - Tirants

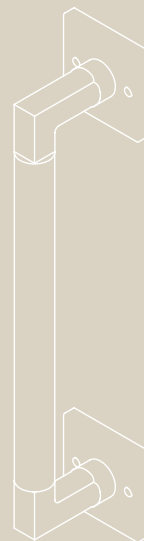

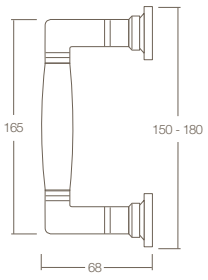

0018.426193	110/180mm
0018.426192	75/150mm



426193

0018.426193

Deurgreep Ton 110/180mm op vierkant rozet.
Eenzijdige bevestiging. Nikkel/ebbenhout.



Pull handle Ton 110/180mm on square roze.
One side fixing. Nickel/ebony.

Stoßgriff Ton 110/180mm auf Eckige Rosette.
Einseitiger Befestigung. Vernickelt/Ebenholz.

Tirant modèle Ton 110/180mm avec rosace carrée.
Montage unilatérale. Nickelé/bois d'ébène.

Nikkel - Nickel - Vernickelt - Nicklé

Toebehoren - Meubelgrepen

0018

Accessories - Furniture handles

Zubehör - Möbelgriffe

Accessoires - Poignées de meuble

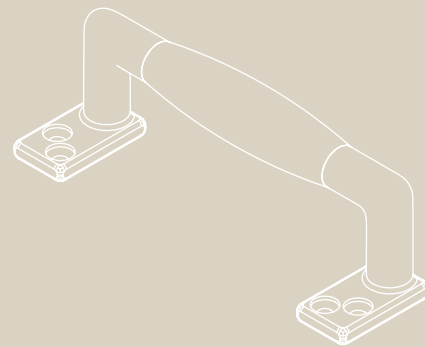

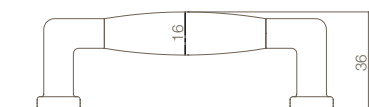
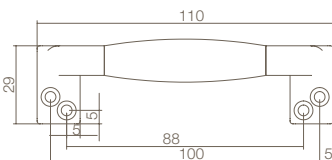
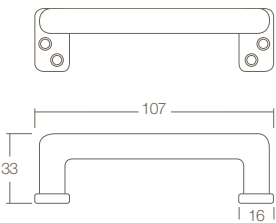
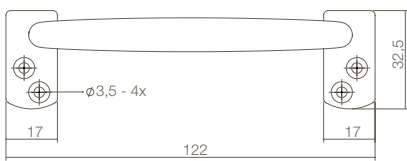
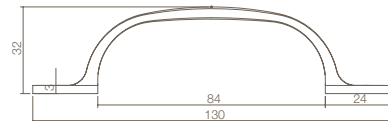
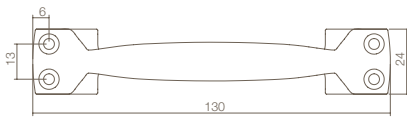

561600

0018.561600 Handgreep op vierkante voet 130mm. Nikkel.



Handle on square base 130mm. Nickel.

Möbelgriff eckige Grundlage 130mm. Vernickelt.

Poignée base carrée 130mm. Nickelé.



561601

0018.561601 Handgreep haags model 122mm. Nikkel.



Handle 122mm. Nickel.

Möbelgriff 122mm. Vernickelt.

Poignée 122mm. Nickelé.



561620

0018.561620 Handgreep recht 107mm. Nikkel.



Handle straight 107mm. Nickel.

Möbelgriff Recht 107mm. Vernickelt.

Poignée droit 107mm. Nickelé.



561640

0018.561640 Handgreep recht. 110mm. Nikkel/ebbenhout.



Handle straight. 110mm. Nickel/ebony.

Möbelgriff Recht. 110mm. Vernickelt/Ebenholz.

Poignée modèle droit. 110mm. Nickelé/bois d'ébène.

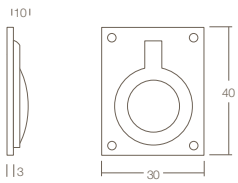

0018.752510	40x30mm
0018.752520	51x38mm
0018.752530	60x47mm



752510

0018.752510

Luikring recht 40x30mm. Nikkel.



Hatch ring 40x30mm. Nickel.

Lukeningring 40x30mm. Vernickelt.

Anneau trappe 40x30mm. Nicklé.

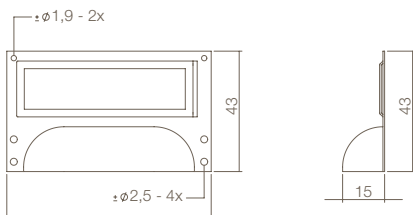

881000

0018.881000

Etiketgreep. Nikkel.



Label grip. Nickel.

Möbelgriff Etikett. Vernickelt.

Poignée Coquille. Nicklé.

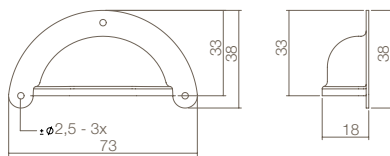

0018.881040	73x33mm
0018.881041	96x43mm



881040

0018.881040

Schelpgreep. Nikkel.



Grip model Shell. Nickel.

Möbelgriff Schale. Vernickelt.

Poignée Coquille. Nicklé.

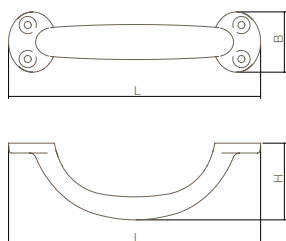

	L	H	B
0018.881100	85mm	28mm	24mm
0018.881101	115mm	35mm	27,5mm
0018.881102	130mm	39mm	31mm
0018.881103	156mm	39mm	35mm



881100

0018.881100

Greep geperst. Nikkel.



Grip pressed. Nickel.

Möbelgriff gequetscht. Vernickelt.

Poignée comprimée. Nicklé.



Nikkel - Nickel - Vernickelt - Nicklé

Toebehoren - Leuninghouders

0018

Accessories - Handrail brackets

Zubehör - Handlaufstützen

Accessoires - Supports de rampe



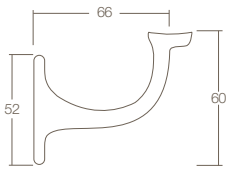

0018.724520

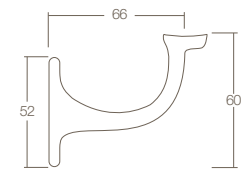

0018.724521

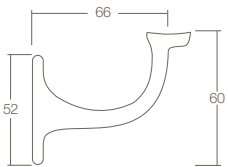

0018.724530



M8

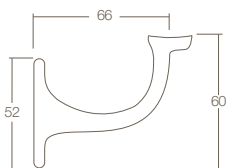

0018.724531



M8



724520

0018.724520

Leuninghouder met schroefgaten. Vlak zadel.
Nikkel.



Handrail bracket screw mounting. Flat saddle.
Nickel.

Handlaufstütze schraubbar. Flach Sattel.
Vernickelt.

Support de rampe. Plaque avec trous de vis.
Selle plate. Nicklé.



724521

0018.724521

Leuninghouder met schroefgaten. Hol zadel.
Nikkel.



Handrail bracket screw mounting. Hollow saddle.
Nickel.

Handlaufstütze, schraubbar. Hohl Sattel.
Vernickelt.

Support de rampe. Plaque avec trous de vis.
Selle creuse. Nicklé.



724530

0018.724530

Leuninghouder centraal M8. Vlak zadel.
Blinde montage. Nikkel.
Incl. bevestigingsmateriaal.



Handrail bracket M8. Flat saddle. Nickel.
Fixing materials included.

Handlaufstütze M8. Flach Sattel. Vernickelt.
inkl. Befestigungsmaterial.

Support de rampe avec petite plaque.
Taraudé M8. Selle plate.
Nicklé. Fixations fournies.



724531

0018.724531

Leuninghouder centraal M8. Hol zadel.
Blinde montage. Nikkel.
Incl. bevestigingsmateriaal.



Handrail bracket M8. Hollow saddle. Nickel.
Fixing materials included.

Handlaufstütze M8. Hohl Sattel. Vernickelt.
inkl. Befestigungsmaterial.

Support de rampe avec petite plaque.
Taraudé M8. Selle creuse.
Nicklé. Fixations fournies.

Nikkel mat - Satin nickel - Nickel matt - Nicklé mat

Binnendeurbeslag - Losse krukken

0019

Interior door hardware - Door handles
Innentürbeschläge - Türdrucker
Garnitures de porte intérieure - Béquilles

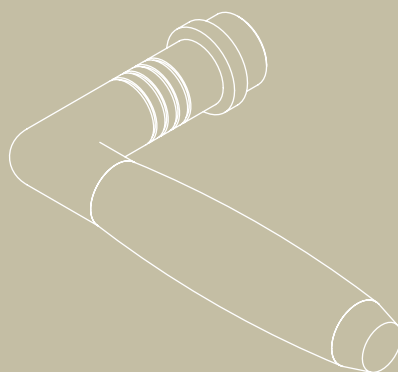

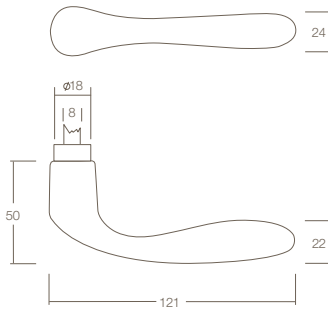

0019.020100

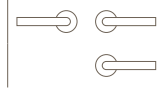

0019.020100A

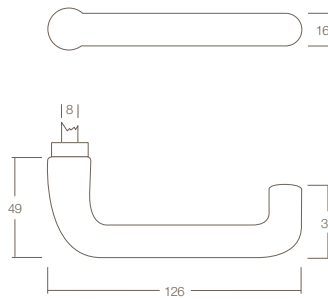

0019.023400

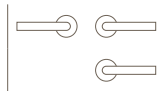

0019.023400A

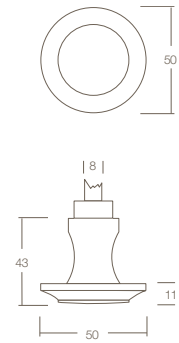

0019.025400

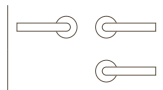

0019.025400A

0201



0019.020100 Deurkruk Banaan. Nikkel mat.



Door handle Banana. Satin nickel.



Türdrücker Banane. Nickel matt.

Béquille Banane. Nicklé mat.

0234



0019.023400 Deurkruk rond. Nikkel mat.



Door handle round. Satin nickel.



Türdrücker Rund. Nickel matt.

Béquille modèle U. Nicklé mat.

0254



0019.025400 Knopkruk 50mm. Nikkel mat.



Knob 50mm. Satin nickel.



Knopf 50mm. Nickel matt.

Bouton 50mm. Nicklé mat.

Accessoires
Accessories
Zubehör

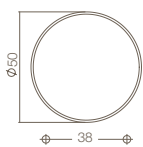

0019.318604



0019.318616



0019.318617



0019.318660



0019.318657

8mm ⌀
5mm ⌀



0019.315604



0019.315616



0019.315617



0019.315619



0019.315620



0019.315660

8mm ⌀



0019.370557

5mm ⌀

0019.370558

6mm ⌀

0019.370560

8mm ⌀

0019.370660

8mm ⌀ verlengd



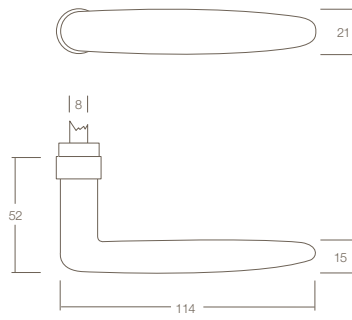

0019.022500

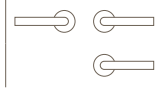

0019.022500A

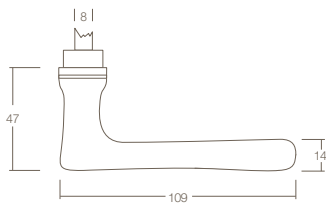

0019.038800

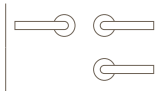

0019.038800A

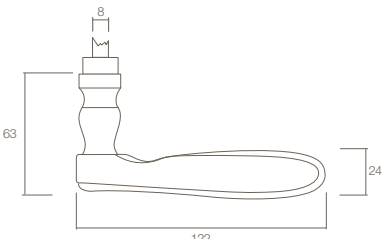

0019.027700

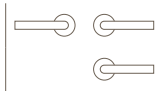

0019.027700A

0019.027700B



0225

0019.022500

Deurkruk Sophie. Nikkel mat.



Door handle Sophie. Satin nickel.



Türdrücker Sophie. Nickel matt.

Béquille Sophie. Nicklé mat.



0388

0019.038800

Deurkruk Trento. Nikkel mat.



Door handle Trento. Satin nickel.



Türdrücker Trento. Nickel matt.

Béquille Trento. Nicklé mat.



0277

0019.027700

Deurkruk Wing met rand. Nikkel mat.



Door handle Wing. Satin nickel.



Türdrücker Wing. Nickel matt.

Béquille Wing avec bord. Nicklé mat.

Accessoires

Accessories
Zubehör



0019.317304



0019.317316



0019.317317

0019.317360 ∇ 8mm \odot 

0019.322004

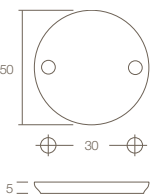

0019.253811



0019.253011

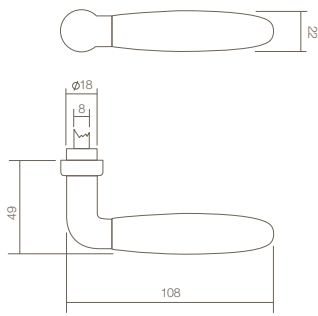

0019.022200

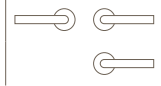

0019.022200A

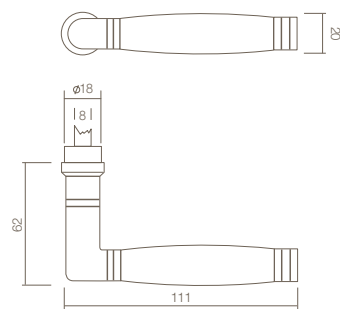

0019.037500

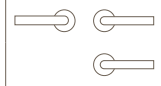

0019.037500A

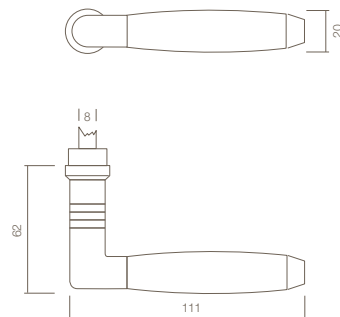

0019.037700

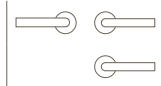

0019.037700A



0222

0019.022200

Deurkruk Tessa. Nikkel mat/zwart hout.



Door handle Tessa. Satin nickel/black wood.



Türdrücker Tessa. Nickel matt/Schwarzes Holz.

Béquille Tessa. Nicklé mat/bois noir.



0375

0019.037500

Deurkruk Ton 222. Nikkel mat/ebbenhout.



Door handle Ton 222. Satin nickel/ebony.



Türdrücker Ton 222. Nickel matt/Ebenholz.

Béquille Ton 222. Nicklé mat/bois d'ébène.



0377

0019.037700

Deurkruk Ton 400. nikkel mat/ebbenhout.



Door handle Ton 400. Satin nickel/ebony.



Türdrücker Ton 400. Nickel matt/Ebenholz.

Béquille Ton 400. Nicklé mat/bois d'ébène.

Accessoires Accessories Zubehör

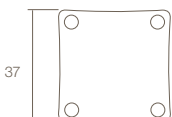

0019.318304



0019.318316



0019.318317

0019.318360 ∇ 8mm \odot 

0019.370002



0019.370001



0019.322004



0019.371060

8mm \odot 

0019.661645



0019.370003



0019.370101



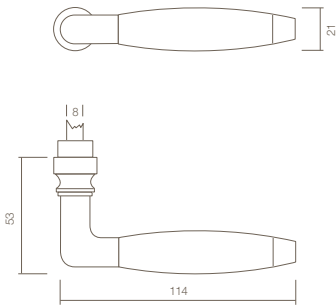

0019.037100

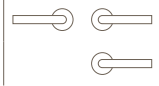

0019.037100A

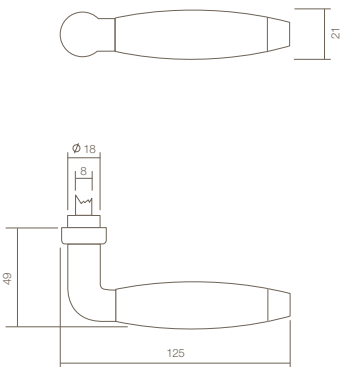

0019.042000

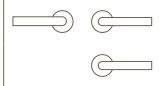

0019.042000A

0371



0019.037100

Deurkruk Marloes. Nikkel mat/ebbenhout.



Door handle Marloes. Satin nickel/ebony.



Türdrücker Marloes. Nickel matt/Ebenholz.

Béquille Marloes. Nicklé mat/bois d'ébène.

0420



0019.042000

Deurkruk Antonnet. Nikkel mat/ebbenhout.



Door handle Antonnet. Satin nickel/ebony.



Türdrücker Antonnet. Nickel matt/Ebenholz.

Béquille Antonnet. Nicklé mat/bois d'ébène.

Accessoires
Accessories
Zubehör

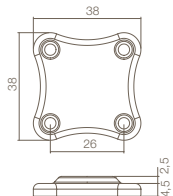

0019.318904



0019.318916



0019.318960 ∇ 8mm \odot



0019.371060 ∇ 8mm \odot



0019.322004



0019.370002



0019.370003



0019.370001



0019.370101



0019.253811



0019.253011

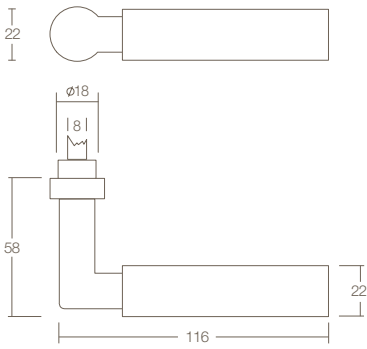

0019.037800

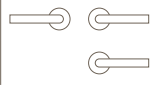

0019.037800A



0378

0019.037800

Deurkruk Bau-stil. Nikkel mat.



Door handle Bau-stil. Satin nickel.



Türdrücker Bau-stil. Nickel matt.

Béquille Bau-stil. Nicklé mat.

Accessoires
Accessories
Zubehör

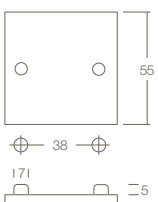

0019.318404



0019.318416



0019.318417



0019.318460



8mm



0019.605090



0019.253811



0019.253011

Nikkel mat - Satin nickel - Nickel matt - Nickel mat

Binnendeurbeslag - Schilden

0019









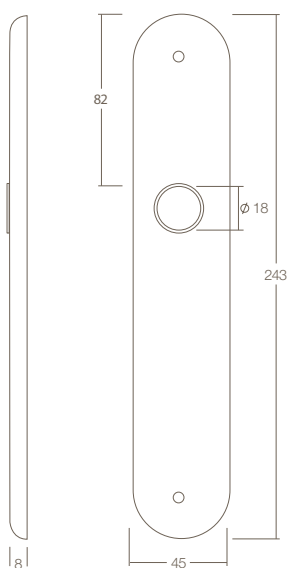

























Interior door hardware - Plates

Innentürbeschläge - Schilder

Garnitures de portes intérieure - Plaqués





0019.253811			-----	
0016.253824				72mm
0019.253826				WC 55/8
0019.253828				110mm
0019.253829				55mm
0019.253836				72mm
0019.253854				110mm
0019.253855				73.5mm
0019.253862				WC 55/8
0019.253863				WC 57/5
0019.253865				WC 63/8
0019.253867				WC 72/8

Optie: Te combineren met deurkrukken op pagina 154 - 158.

Option: Combine with doorhandles from page 154 - 158.

Option: Zu kombinieren mit Türdrücker auf Seite 154 - 158.

Option: Une combinaison possible avec les béquilles de la page 154 - 158.



2538

0019.253811

Schild breed ovaal. Nikkel mat.

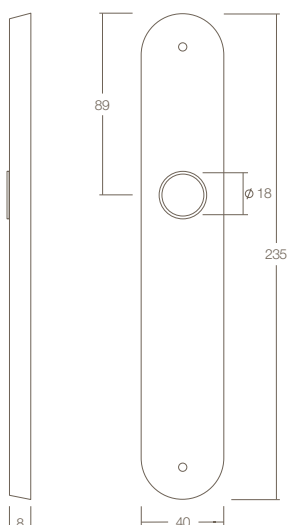





































Plate oval. Satin nickel.



Schild. Oval. Nickel matt.

Plaque. Large arrondie. Nicklé mat.



0019.253011			-----	
0019.253024				56mm
0019.253026				72mm
0019.253029				55mm
0019.253036				72mm
0019.253049				92mm
0019.253062				WC 55/8
0019.253063				WC 57/5
0019.253064				WC 57/8
0019.253065				WC 63/8
0019.253067				WC 72/8
0019.253069				WC 78/8

Optie: Te combineren met deurkrukken op pagina 154 - 158.

Option: Combine with doorhandles from page 154 - 158.

Option: Zu kombinieren mit Türdrücker auf Seite 154 - 158.

Option: Une combinaison possible avec les béquilles de la page 154 - 158.



2530

0019.253011

Langschild ovaal. Nikkel mat.



Long plate oval. Satin nickel.



Langschild Oval. Nickel matt.

Plaque longue arrondie. Nicklé mat.

Accessoires

Accessories
Zubehör



0019.315620

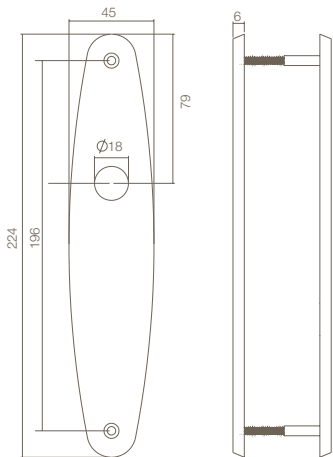

0019.258011				---	
0019.258024				56mm	
0019.258026				72mm	
0019.258029				55mm	
0019.258036				72mm	
0019.258055				73.5mm	
0019.258062				WC 55/8	
0019.258063				WC 57/5	
0019.258065				WC 63/8	
0019.258067				WC 72/8	

Optie: Te combineren met deurkrukken op pagina 154 - 158.

Option: Combine with doorhandles from page 154 - 158.

Option: Zu kombinieren mit Türdrücker auf Seite 154 - 158.

Option: Une combinaison possible avec les béquilles de la page 154 - 158.



0019.258011 Schild ellips. Nikkel mat.



Plate ellipse. Satin nickel.



Schild Ellipse. Nikkel matt.

Plaque Ellipse. Nicklé mat.

2580

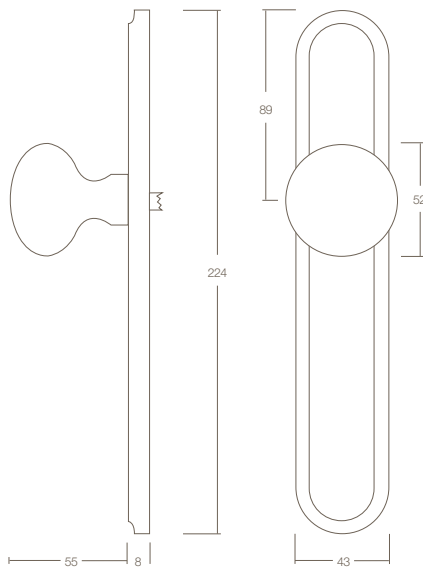

0019.212611			56mm
0019.212624			72mm
0019.212636			

Optie: Te combineren met deurkrukken op pagina 154 - 158.

Option: Combine with doorhandles from page 154 - 158.

Option: Zu kombinieren mit Türdrücker auf Seite 154 - 158.

Option: Une combinaison possible avec les béquilles de la page 154 - 158.



0019.212611 Knopkruk vast op langschild ovaal. Nikkel mat. Met stift M10 x 8 x 89mm.



Knob fixed on long plate oval. Satin nickel. Spindle M10 x 8 x 89mm.

Knopf Fest auf Langschild Oval. Nickel Matt. Stift M10 x 8 x 89mm.

Bouton fixe sur plaque longue ovale. Nicklé mat. Tige M10 x 8 x 89mm.

2126

Accessoires

Accessories
Zubehör









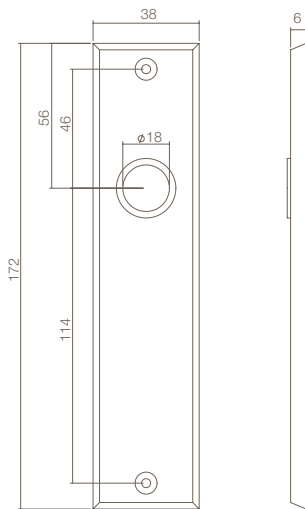















0099.975387	M10		□ 8x80mm	≤ 42
0099.975382	M10		□ 8x90mm	≤ 60
0099.975381	M10		□ 9x90mm	≤ 90



0019.315620



0019.256611			-----	
0019.256624				56mm
0019.256626				72mm
0019.256629				55mm
0019.256636				72mm
0019.256662				WC 55/8
0019.256663				WC 57/5
0019.256665				WC 63/8

Optie: Te combineren met deurkrukken op pagina 154 - 158.

Option: Combine with doorhandles from page 154 - 158.

Option: Zu kombinieren mit Türdrücker auf Seite 154 - 158.

Option: Une combinaison possible avec les béquilles de la page 154 - 158.



2566

0019.256611

Kortschild rethoekig, afgeschuind. Nikkel mat.











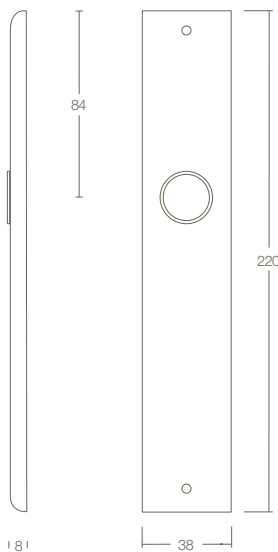











Shortplate. Chamfered. Satin nickel.



Kurtschild. Gefast. Nikkel matt.

Plaque courte rectangulaire chanfreiné. Nicklé matt.



0019.257611			-----	
0019.257624				56mm
0019.257626				72mm
0019.257629				55mm
0019.257662				WC 55/8
0019.257663				WC 57/5
0019.257665				WC 63/8

Optie: Te combineren met deurkrukken op pagina 154 - 158.

Option: Combine with doorhandles from page 154 - 158.

Option: Zu kombinieren mit Türdrücker auf Seite 154 - 158.

Option: Une combinaison possible avec les béquilles de la page 154 - 158.



2576

0019.257611

Langschild. afgeschuind. Nikkel mat.



Long plate. Chamfered. Satin nickel.



Langschild. Gefast. Nikkel matt.

Plaque longue rectangulaire chanfreiné. Nicklé matt.









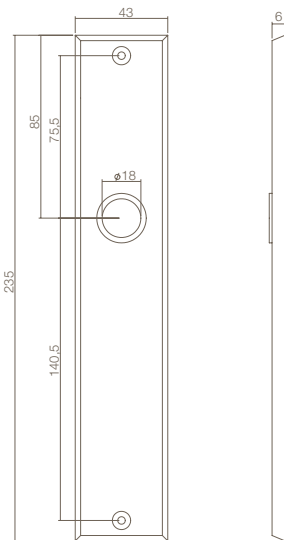



















Accessoires

Accessories
Zubehör



0019.315620



0019.257711			-----	
0019.257724				56mm
0019.257726				72mm
0019.257729				55mm
0019.257736				72mm
0019.257749				92mm
0019.257762				WC 55/8
0019.257763				WC 57/5
0019.257765				WC 63/8
0019.257767				WC 72/8

Optie: Te combineren met deurkrukken op pagina 154 - 158.

Option: Combine with doorhandles from page 154 - 158.

Option: Zu kombinieren mit Türdrücker auf Seite 154 - 158.

Option: Une combinaison possible avec les béquilles de la page 154 - 158.



2577

0019.257711











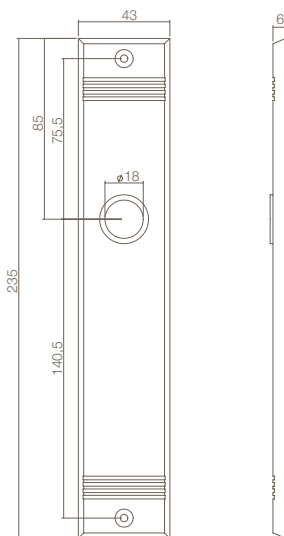





















Renovatie langschild rechthoekig voor krukken met krukhalshoofd ϕ 18mm. Nikkel mat 235mm x 43mm x 6mm.

Renovationplate. For door handles with insert ϕ 18mm. Satin nickel. 235mm x 43mm x 6mm.

Renovationslangschild eckig. Für Türdrücker mit Drücker Hals ϕ 18mm. Nickel matt. 235mm x 43mm x 6mm.

Plaque de renovation longue rectangulaire. 235mm x 43mm x 6mm. Pour l'usage des béquilles avec cou de ϕ 18mm. Nicklé mat.



0019.257111			-----	
0019.257124				56mm
0019.257126				72mm
0019.257129				55mm
0019.257136				72mm
0019.257149				92mm
0019.257162				WC 55/8
0019.257163				WC 57/5
0019.257165				WC 63/8
0019.257167				WC 72/8

Optie: Te combineren met deurkrukken op pagina 154 - 158.

Option: Combine with doorhandles from page 154 - 158.

Option: Zu kombinieren mit Türdrücker auf Seite 154 - 158.

Option: Une combinaison possible avec les béquilles de la page 154 - 158.



2571

0019.257111



Langschild rechthoekig met groef. Nikkel mat.

Long plate straight with chamfer. Satin nickel.

Langschild eckig. Mit Furche. Nickel matt.

Plaque longue rectangulaire avec rainure. Nicklé mat.

Accessoires

Accessories

Zubehör



0019.315620



Nikkel mat - Satin nickel - Nickel matt - Nicklé mat

Binnendeurbeslag, vastdraaibaar - Rond

0019

Interior door hardware, springloaded - Round

Innentürbeschläge, Festdrehbar - Rund

Garnitures de porte intérieure, avec ressort - Rond

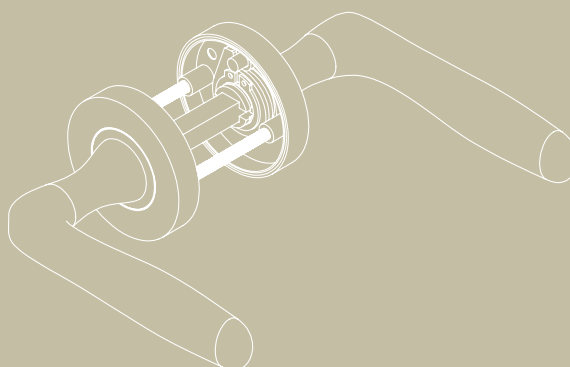

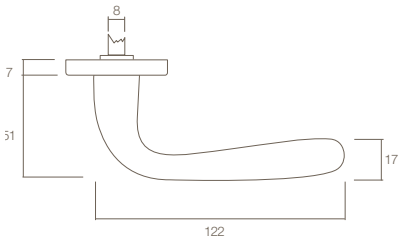
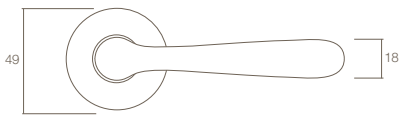

0019.019502

0019.019502A

0019.019502B

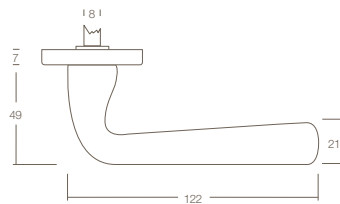
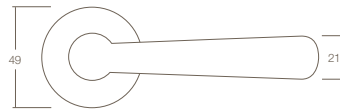
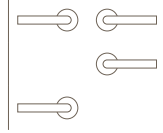

0019.019702

0019.019702A

0019.019702B

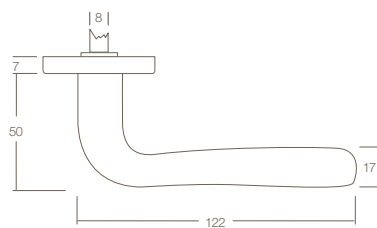
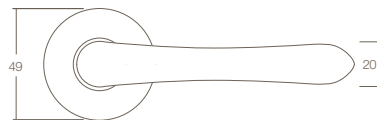
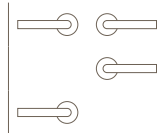

0019.019802

0019.019802A

0019.019802B

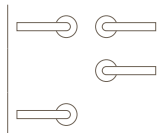

0195

0019.019502

Deurkruk Jupiter vastdraaibaar met veer op ronde rozet. Nikkel mat.



Springloaded door handle Jupiter on round rose. Satin nickel



Türdrücker Jupiter festdrehbar gelagert mit Feder auf runder Rosette. Nickel matt.



Béquille Jupiter sertie sur rosace ronde avec ressort. Nicklé mat.



0197

0019.019702

Deurkruk Yvonne vastdraaibaar met veer op ronde rozet. Nikkel mat.



Springloaded door handle Yvonne on round rose. Satin nickel



Türdrücker Yvonne festdrehbar gelagert mit Feder auf runder Rosette. Nickel matt.



Béquille Yvonne sertie sur rosace ronde avec ressort. Nicklé mat.



0198

0019.019802

Deurkruk Saturnus vastdraaibaar met veer op ronde rozet. Nikkel mat.



Springloaded door handle Saturnus on round rose. Satin nickel



Türdrücker Saturnus festdrehbar gelagert mit Feder auf runder Rosette. Nickel matt.



Béquille Saturnus sertie sur rosace ronde avec ressort. Nicklé mat.

Accessoires Accessories Zubehör

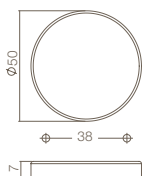

0019.318616



0019.318617



0019.318660



8mm

0016.318657

5mm



0019.370960



8mm

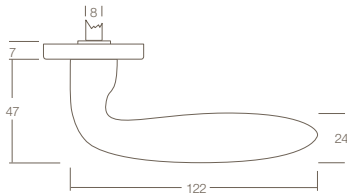
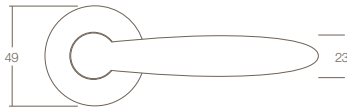

0019.019902

0019.019902A

0019.019902B

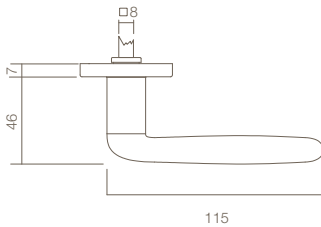
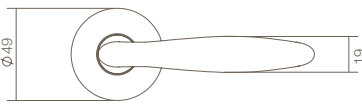
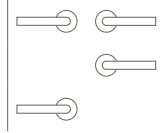

0019.020002

0019.020002A

0019.020002B

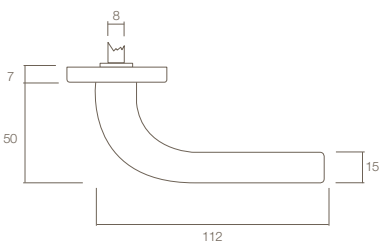
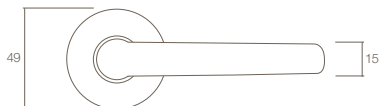
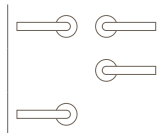

0019.023102

0019.023102A

0019.023102B

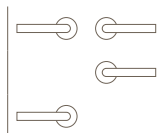

0199



0019.019902

Deurkruk Sigaar vastdraaibaar met veer op ronde rozet. Nikkel mat.



Springloaded door handle cigar on round rose. Satin nickel



Türdrücker Zigarre festdrehbar gelagert mit Feder auf runder Rosette. Nickel matt.



Béquille Cigare sertie sur rosace ronde avec ressort. Nicklé mat.

0200



0019.020002

Deurkruk Phobos vastdraaibaar met veer op ronde rozet. Nikkel mat.



Springloaded door handle Phobos on round rose. Satin nickel



Türdrücker Phobos festdrehbar gelagert mit Feder auf runder Rosette. Nickel matt.



Béquille Phobos sertie sur rosace ronde avec ressort. Nicklé mat.

0231



0019.023102

Deurkruk Elena vastdraaibaar met veer op ronde rozet. Nikkel mat.



Springloaded door handle Elena on round rose. Satin nickel



Türdrücker Elena festdrehbar gelagert mit Feder auf runder Rosette. Nickel matt.



Béquille Elena sertie sur rosace ronde avec ressort. Nicklé mat.

Accessoires

Accessories
Zubehör

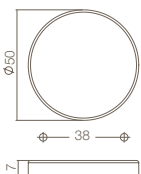

0019.318616



0019.318617



0019.318660



5mm

0019.318657

8mm



0019.370960



8mm

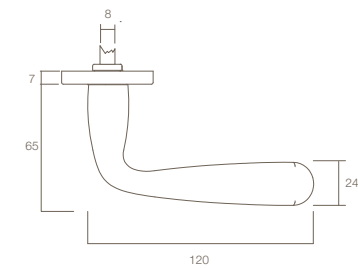
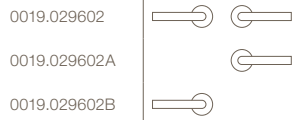
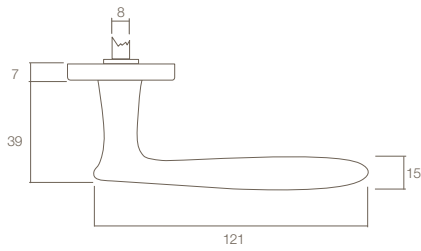
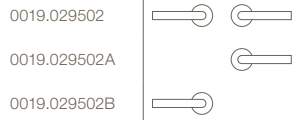
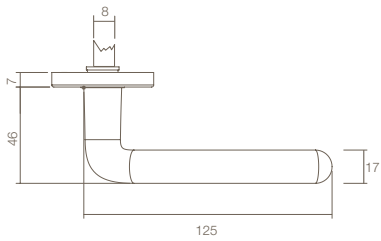
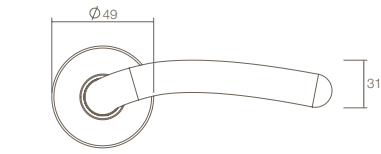

0295



0019.029502 Deurkruk Alice vastdraaibaar met veer op ronde rozet. Nikkel mat.



Springloaded door handle Alice on round rose. Satin nickel



Türdrücker Alice festdrehbar gelagert mit Feder auf runder Rosette. Nickel matt.



Béquille Alice sertie sur rosace ronde avec ressort. Nicklé mat.

0296



0019.029602 Deurkruk Natalia vastdraaibaar met veer op ronde rozet. Nikkel mat.



Springloaded door handle Natalia on round rose. Satin nickel



Türdrücker Natalia festdrehbar gelagert mit Feder auf runder Rosette. Nickel matt.



Béquille Natalia sertie sur rosace ronde avec ressort. Nicklé mat.

0302



0019.030202 Deurkruk Neptunus vastdraaibaar met veer op ronde rozet. Nikkel mat.



Springloaded door handle Neptunus on round rose. Satin nickel



Türdrücker Neptunus festdrehbar gelagert mit Feder auf runder Rosette. Nickel matt.



Béquille Neptunus sertie sur rosace ronde avec ressort. Nicklé mat.

Accessoires

Accessories
Zubehör

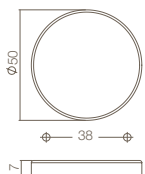

0019.318616



0019.318617



0019.318660



0016.318657



5mm

8mm



0019.370960



8mm

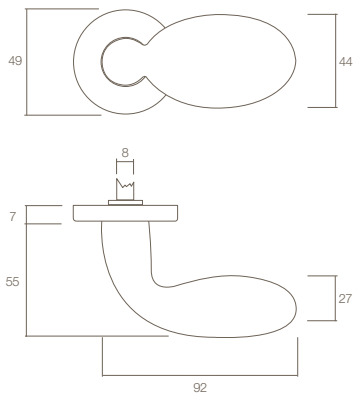

0019.026302



0019.026302A



0019.026302B



0263

0019.026302

Knopkruk Druppel vastdraaibaar met veer op ronde rozet. Nikkel mat.



Springloaded door handle Drop on round rose. Satin nickel.



Türdrücker Tropf festdrehbar gelagert mit Feder auf runder Rosette. Nickel matt.



Béquille Bouton sertie sur rosace ronde, avec ressort. Nicklé mat.

Accessoires

Accessories
Zubehör

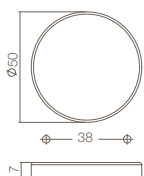

0019.318616



0019.318617



0019.318660

0019.318657



5mm

8mm



0019.370960



8mm

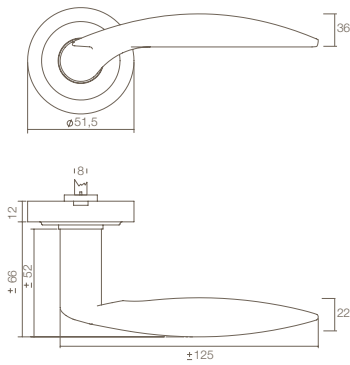

0019.031102



0019.031102A



0019.031102B



0311

0019.031102

Deurkruk Marsala vastdraaibaar met veer op ronde rozet. Nikkel mat.



Springloaded door handle Marsala on round rose. Satin nickel



Türdrücker Marsala festdrehbar gelagert mit Feder auf runder Rosette. Nickel matt.



Béquille Marsala sertie sur rosace ronde avec ressort. Nickelé mat.

Accessoires

Accessories
Zubehör

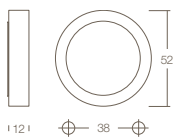

0019.314716



0019.314717



0019.314760



0019.370960



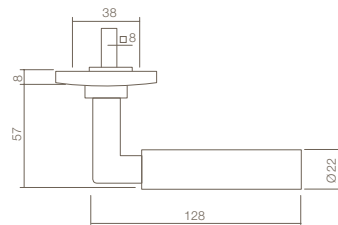
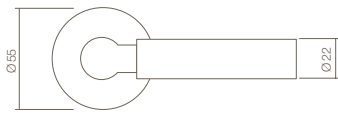

0019.037802

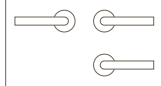

0019.037802A

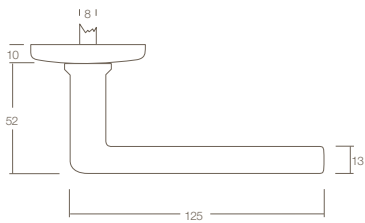
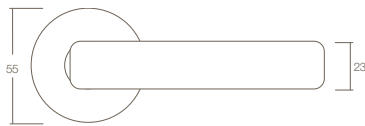

0019.038702

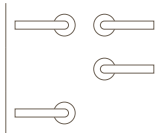

0019.038702A

0019.038702B



0378

0019.037802

Deurkruk Bau-Stil vastdraaibaar met veer op ronde rozet. Nikkel mat.



Springloaded door handle Bau-Stil on round rose. Satin nickel.



Türdrücker Bau-Stil festdrehbar gelagert mit Feder auf runder Rosette. Nickel matt.



Béquille Bau-Stil sertie sur rosace ronde, avec ressort. Nickelé mat.



0387

0019.038702

Deurkruk vierkant vastdraaibaar met veer op ronde rozet. Nikkel mat.



Springloaded door handle square on round rose. Satin nickel



Türdrücker eckig festdrehbar gelagert mit Feder auf runder Rosette. Nickel matt.



Béquille carrée sertie sur rosace ronde avec ressort. Nickelé mat.

Accessoires

Accessories
Zubehör

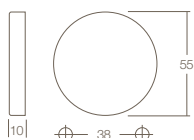

0019.316316



0019.316317



0019.316360



8mm



0019.605090

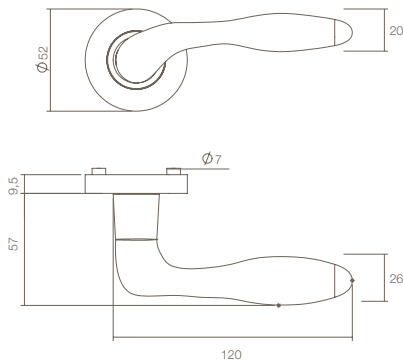

0019.169502

0019.169502A

0019.169502B

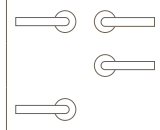

1695

0019.169502

Deurkruk George, vastdraaibaar met veer op ronde rozet. Nokken \varnothing 7mm. Nikkel mat



Springloaded door handle George on round rose. Lugs \varnothing 7mm. Satin nickel.



Türdrücker George festdrehbar gelagert mit Feder auf runder Rosette. Stütznocken \varnothing 7mm. Nickel matt.

Béquille George sertie sur rosace ronde avec ressort. Tenons \varnothing 7mm. Nicklé mat.

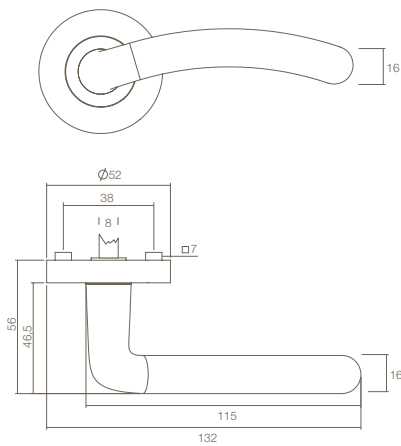

0019.169902

0019.169902A

0019.169902B

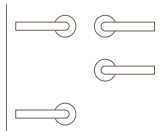

1699

0019.169902

Deurkruk Marieke, vastdraaibaar met veer op ronde rozet. Nokken \varnothing 7mm. Nikkel mat.



Springloaded door handle Marieke on round rose. Lugs \varnothing 7mm. Satin nickel.



Türdrücker Marieke festdrehbar gelagert mit Feder auf runder Rosette. Stütznocken \varnothing 7mm. Nickel matt

Béquille Marieke sertie sur rosace ronde avec ressort. Tenons \varnothing 7mm. Nicklé mat.

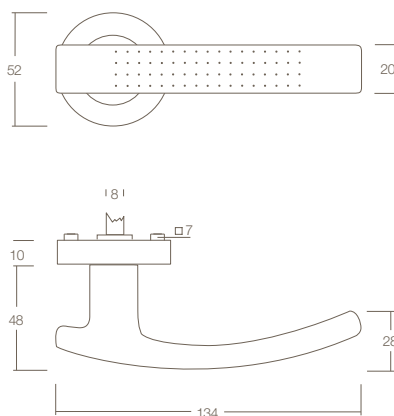

0019.169602

0019.169602A

0019.169602B

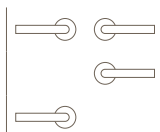

1696

0019.169602

Deurkruk William, vastdraaibaar met veer op ronde rozet. Nokken \varnothing 7mm. Nikkel mat.



Springloaded lever William Bryan on round rose. Lugs \varnothing 7mm. Satin nickel.



Türdrücker William festdrehbar gelagert mit Feder auf runder Rosette. Stütznocken \varnothing 7mm. Nickel matt

Béquille William sertie sur rosace ronde avec ressort. Tenons \varnothing 7mm. Nicklé mat.

Accessoires

Accessories
Zubehör

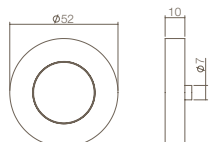

0016.347616



0016.347617



0016.347618



0016.347716



0016.347658

0016.347659

0016.347660



6mm

7mm

7mm



0019.212600

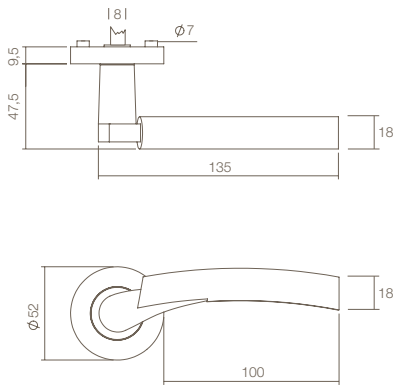

0019.170002



0019.170002A



0019.170002B

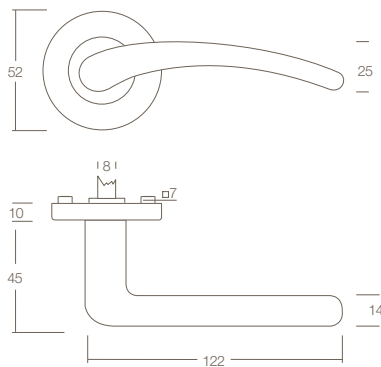

0019.170302



0019.170302A



0019.170302B

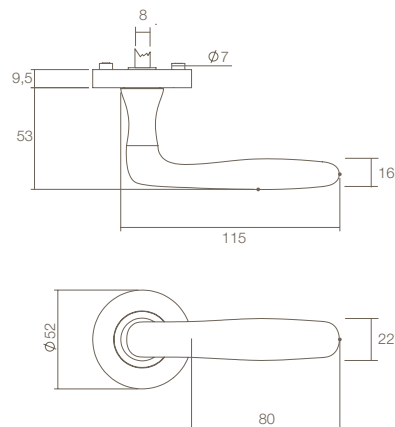

0019.169202



0019.169202A



0019.169202B



1700

0019.170002

Deurkruk Bryan, vastdraaibaar met veer op ronde rozet. Nokken ø7mm. Nikkel mat.



Springloaded door handle Bryan on round rose. Lugs ø7mm. Satin nickel.



Türdrücker Bryan festdrehbar gelagert mit Feder auf runder Rosette. Stütznocken ø7mm. Nickel matt

Béquille Bryan sertie sur rosace ronde avec ressort. Tenons ø7mm. Nicklé mat.



1703

0019.170302

Deurkruk Matthijs, vastdraaibaar met veer op ronde rozet. Nokken ø7mm. Nikkel mat.



Springloaded door handle Matthijs on round rose. Lugs ø7mm. Satin nickel.



Türdrücker Matthijs festdrehbar gelagert mit Feder auf runder Rosette. Stütznocken ø7mm. Nickel matt

Béquille Matthijs sertie sur rosace ronde avec ressort. Tenons ø7mm. Nicklé mat.



1692

0019.169202

Deurkruk Bjorn vastdraaibaar met veer op ronde rozet. Nokken ø7mm. Nikkel mat.



Springloaded door handle Bjorn on round rose. Lugs ø7mm. Satin nickel



Türdrücker Bjorn festdrehbar gelagert mit Feder auf runder Rosette. Stütznocken ø7mm. Nickel matt.

Béquille Bjorn sertie sur rosace ronde avec ressort. Tenons ø7mm. Nicklé mat.

Accessoires

Accessories
Zubehör

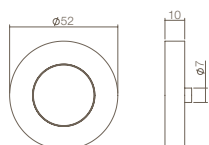

0016.347616



0016.347617



0016.347618



0016.347716



0016.347658 6mm

0016.347659 7mm

0016.347660 7mm



0016.212600

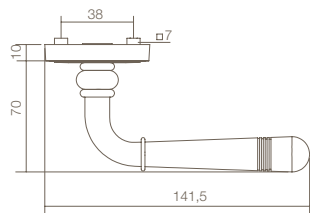
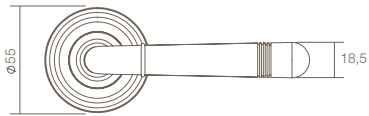

0019.172502					
0019.172502A					
0019.172502B					
0019.172503					
0019.172505					
0019.172510					WC 8mm



1725

0019.172502

Deurkruk Emily, vastdraaibaar met veer op ronde rozet. Nokken ø7mm. Nikkel mat.



Springloaded door handle Emily on round rose. Lugs ø7mm. Satin nickel.



Türdrücker Emily festdrehbar gelagert mit Feder auf runder Rosette. Stütznocken ø7mm. Nickel matt



Béquille Emily sertie sur rosace ronde avec ressort. Tenons ø7mm. Nicklé mat.

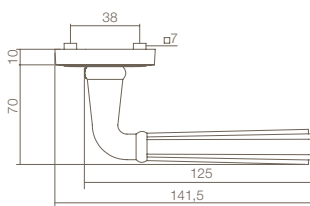
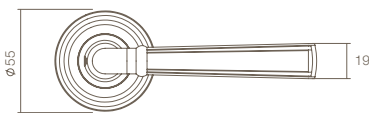

0019.173502					
0019.173502A					
0019.173502B					
0019.173503					
0019.173505					
0019.173510					WC 8mm



1735

0019.173502

Deurkruk Bellevue, vastdraaibaar met veer op ronde rozet. Nokken ø7mm. Nikkel mat.



Springloaded door handle Bellevue on round rose. Lugs ø7mm. Satin nickel.



Türdrücker Bellevue festdrehbar gelagert mit Feder auf runder Rosette. Stütznocken ø7mm. Nickel matt



Béquille Bellevue sertie sur rosace ronde avec ressort. Tenons ø7mm. Nicklé mat.

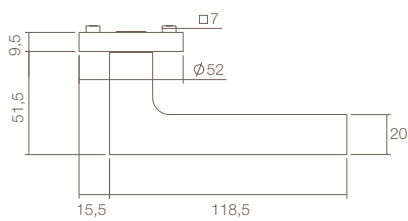
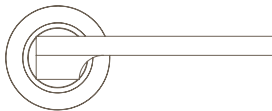

0019.170502					
0019.170502A					
0019.170502B					
0019.170503					
0019.170505					
0019.170510					WC 8mm



1705

0019.170502

Deurkruk Ben, vastdraaibaar met veer op ronde rozet. Nokken ø7mm. Nikkel mat.



Springloaded door handle Ben on round rose. Lugs ø7mm. Satin nickel.









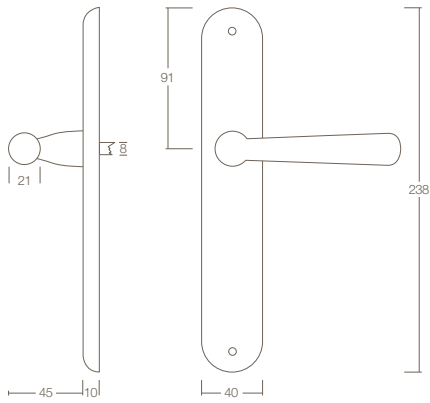























Türdrücker Ben festdrehbar gelagert mit Feder auf runder Rosette. Stütznocken ø7mm. Nickel matt

Béquille Ben sertie sur rosace ronde avec ressort. Tenons ø7mm. Nicklé mat.





0019.019711			-----	
0019.019711A			-----	
0019.019711B			-----	
0019.019724				56mm
0019.019726				72mm
0019.019729				55mm
0019.019736				72mm
0019.019762				WC 55/8
0019.019763				WC 57/5
0019.019765				WC 63/8
0019.019767				WC 72/8



0197

0019.019711

Deurkruk Yvonne, vastdraaibaar met veer op langschild ovaal. Nikkel mat.



Springloaded door handle Yvonne on oval long plate. Satin nickel.









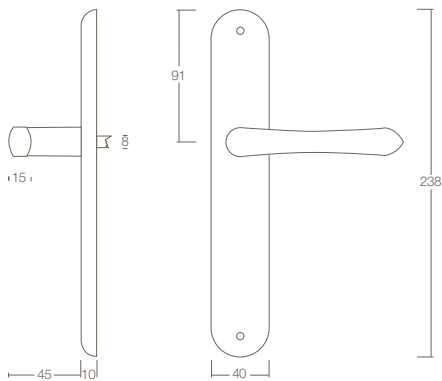

















Türdrücker Yvonne. Festdrehbar ghelagert mit feder auf Langschild Oval. Nickel matt.



Béquille Yvonne sertie sur plaque longue ovale avec ressort. Nicklé mat.



0019.019811			-----	
0019.019811A			-----	
0019.019811B			-----	
0019.019824				56mm
0019.019829				55mm
0019.019836				72mm
0019.019863				WC 57/5
0019.019865				WC 63/8
0019.019867				WC 72/8



0198

0019.019811

Deurkruk Saturnus, vastdraaibaar met veer op langschild ovaal. Nikkel mat.



Springloaded door handle Saturnus on oval long plate. Satin nickel.









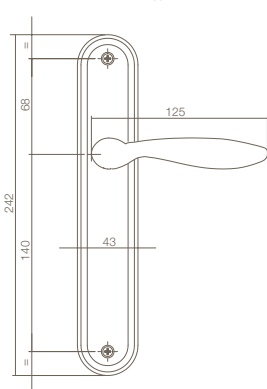
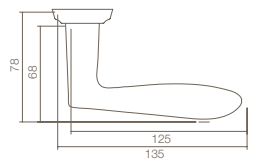
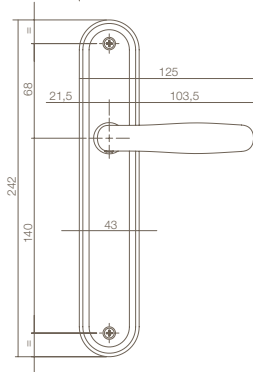
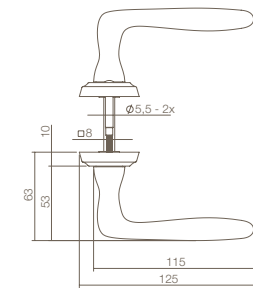









Türdrücker Saturnus. Festdrehbar gelagert mit Feder auf Langschild Oval. Nickel matt.



Béquille Saturnus sertie sur plaque longue ovale avec ressort Nicklé mat.



0019.169211			-----	
0019.169211A			-----	
0019.169211B			-----	
0019.169224				56mm
0019.169236				72mm
0016.168265			 	WC 63/8



1692

0019.169211

Deurkruk Bjorn vastdraaibaar met veer op langschild ovaal. Nikkel mat.





























Springloaded door handle Bjorn on oval long plate. Satin nickel.



Türdrücker Bjorn. Festdrehbar gelagert mit Feder auf Langschild Oval. Nickel matt.



Béquille Bjorn sertie sur plaque longue ovale avec ressort. Nicklé mat.

0019.169511			-----	
0019.169511A			-----	
0019.169511B			-----	
0019.169524				56mm
0019.169526				72mm
0019.169529				55mm
0019.169536				72mm
0019.169565			 	WC 63/8
0019.169569			 	WC 72/8



1695

0019.169511

Deurkruk George vastdraaibaar met veer op langschild ovaal. Nikkel mat.



Springloaded door handle George on oval long plate. Satin nickel.



Türdrücker George Festdrehbar gelagert mit Feder auf Langschild Oval. Nickel matt.



Béquille George. sertie sur plaque longue ovale avec ressort. Nicklé mat.









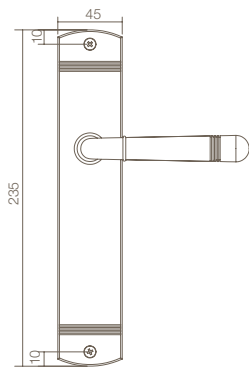
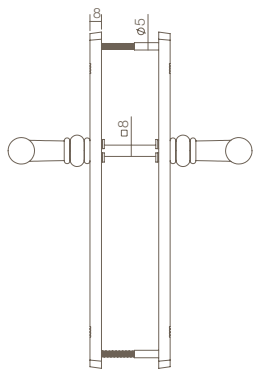



Accessoires

Accessories
Zubehör



0019.212611



0019.170511			-----	
0019.170511A			-----	
0019.170511B			-----	
0019.170526				72mm
0019.170536				72mm
0019.170569				WC 78/8



1705

0019.170511

Deurkruk Emily vastdraaibaar met veer op langschild. Nikkel mat.



Springloaded door handle Emily on long plate. Satin nickel.



Türdrücker Emily Festdrehbar gelagert mit Feder auf Langschild. Nickel matt.



Béquille Emily sertie sur plaque longue avec ressort. Nicklé mat.

Accessoires

Accessories
Zubehör



0019.212611



0019.617050

Nikkel mat - Satin nickel - Nickel matt - Nicklé mat

Binnendeurbeslag, vastdraaibaar - Vierkant

0019

Interior door hardware, springloaded - Square

Innentürbeschläge, Festdrehbar - Eckig

Garnitures de porte intérieure, avec ressort - Carrée

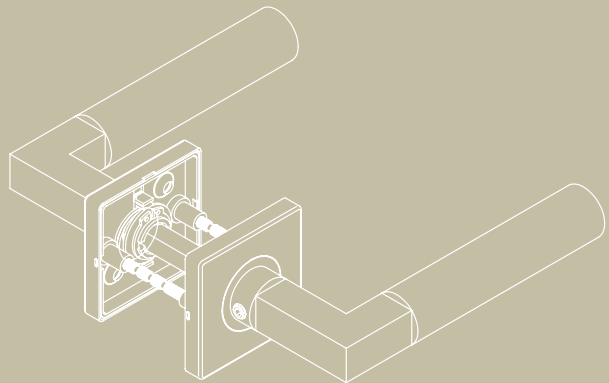

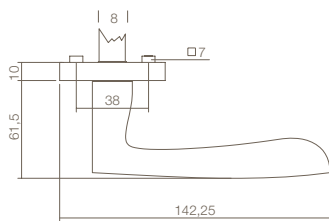
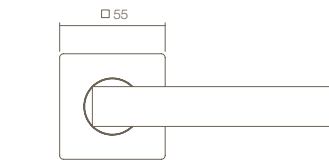

0019.171402



0019.171402A



0019.171402B



1714

0019.171402

Deurkruk Dean, vastdraaibaar met veer op vierkante rozet. Nokken $\varnothing 7\text{mm}$. Chrom/nikkel mat



Springloaded door handle Dean on square rose. Lugs $\varnothing 7\text{mm}$. Chrome/satin nickel.



Türdrücker Dean festdrehbar gelagert mit Feder auf eckiger Rosette. Stütznocken $\varnothing 7\text{mm}$. Chrom/Nickel matt.



Béquille Dean sertie sur rosace carrée avec ressort. Tenons $\varnothing 7\text{mm}$. Chromé/nicklé mat.

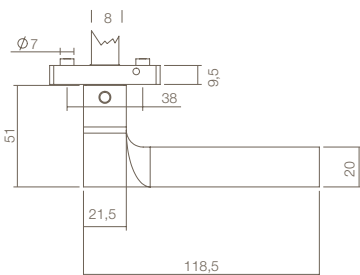
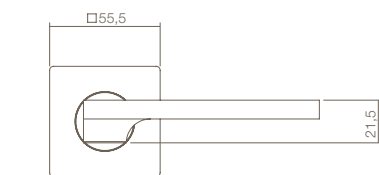

0019.171502



0019.171502A



0019.171502B



1715

0019.171502

Deurkruk Ben, vastdraaibaar met veer op vierkante rozet. Nokken $\varnothing 7\text{mm}$. Chrom/nikkel mat



Springloaded door handle Ben on square rose. Lugs $\varnothing 7\text{mm}$. Chrome/satin nickel.



Türdrücker Ben festdrehbar gelagert mit Feder auf eckiger Rosette. Stütznocken $\varnothing 7\text{mm}$. Chrom/Nickel matt.



Béquille Ben sertie sur rosace carrée avec ressort. Tenons $\varnothing 7\text{mm}$. Chromé/nicklé mat.

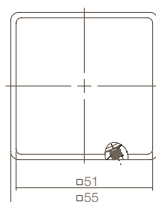
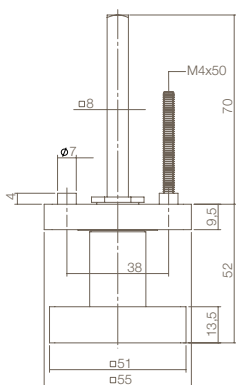

2126

0019.212602

Voordeurknop vierkant centraal vast op vierkant rozet. Nokken $\varnothing 7\text{mm}$. Stift M10 x 8 x 70mm. Nikkel mat.



Front door knob square, centered on square rose. Lugs 7mm. M10 x 8 x 70mm. Satin nickel



Haustürknoopf eckig auf eckiger Rosette. Stütznocken $\varnothing 7\text{mm}$. Stift M10 x 8 x 70mm. Nickel matt

Bouton d'entrée central fixe. Tenons $\varnothing 7\text{mm}$. Tige M10 x 8 x 70mm. Nicklé mat.

Accessoires

Accessories
Zubehör

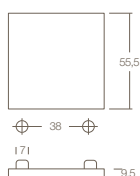

0016.347816



0016.347817



0016.347916



0016.347858

6mm \square

0016.347860

7mm \square

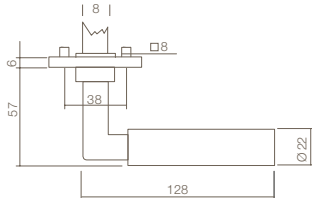
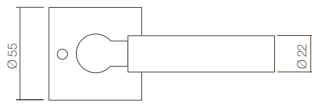

0019.038102



0019.038102A



0019.038102B



0381

0019.038102

Deurkruk Bau-Stil, rond, vastdraaibaar met veer op vierkante rozet. Nikkel mat



Springloaded door handle Bau-Stil, round on square rose. Satin nickel.



Türdrücker Bau-Stil, Rund festdrehbar gelagert mit Feder auf eckiger Rosette. Nickel matt.



Béquille Bau-Stil ronde, sertie sur rosace carrée avec ressort. Nicklé mat.

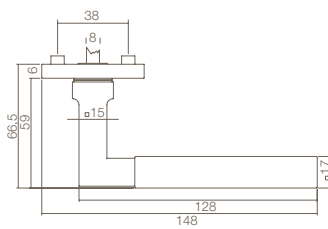
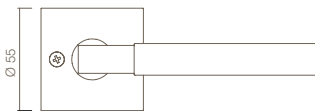

0019.038302



0019.038302A



0019.038302B



0383

0019.038302

Deurkruk Bau-Stil, vierkant, vastdraaibaar met veer op vierkante rozet. Nikkel mat



Springloaded door handle Bau-Stil, square on square rose. Satin nickel.



Türdrücker Bau-Stil, Eckig festdrehbar gelagert mit Feder auf eckiger Rosette. Nickel matt.



Béquille Bau-Stil carrée, sertie sur rosace carrée avec ressort. Nicklé mat.

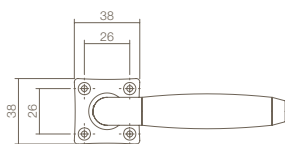
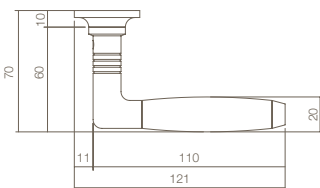

0019.023702



0237

0019.023702

Deurkruk Ton Basic incl. rozet. Nikkel mat.



Lever Ton Basic incl. rose. Satin nickel.



Türdrücker Ton Basic inkl. Rozette. Nickel matt.



Béquille modèle Ton Basic avec rosace. Nicklé mat.

Accessoires

Accessories
Zubehör

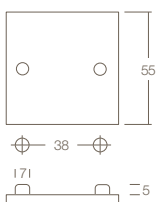

0019.318416



0019.318417



0019.318404



0019.318460



0019.318316



0019.318317



0019.318361



0019.605090



Nikkel mat - Satin nickel - Nickel matt - Nicklé mat

Buitendeurbeslag - Rond / Ovaal

0019

Exterior door hardware - Round / Oval

Außentürbeschläge - Rund / Oval

Garnitures de porte extérieure - Rond / Ovale



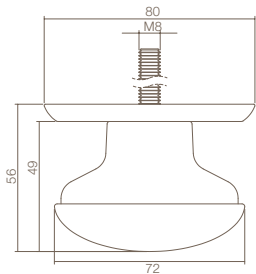
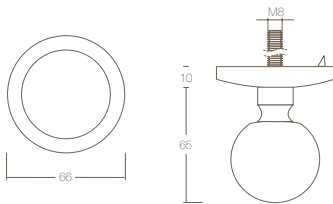
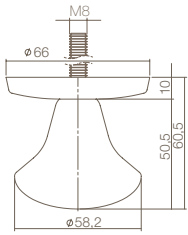

3930

0019.393030

Voordeurknop paddenstoel vast. Doorgaande bevestiging M8. Nikkel mat.



Front door knob mushroom not turnable. Bolt through fixing M8. Satin nickel.

Haustürknoopf Pilz fest mit einseitiger Befestigung M8. Nickel matt.

Bouton d'entrée fixe champignon. Fixation traversante M8. Nicklé mat.



3930

0019.393031

Voordeurknop bolrond vast. Doorgaande bevestiging, M8. Nikkel mat.



Front door knob. Not turnable with bolt. Bolt through fixing M8. Satin nickel.

Haustürknoopf fest mit durchgehender Befestigung M8. Nickel matt.

Bouton d'entrée fixe petite boule. Fixation traversante M8. Nicklé mat.



3930

0019.393033

Voordeurknop zwaar vast. Doorgaande bevestiging, M8. Nikkel mat.



Front door knob. Not turnable with bolt. Bolt through fixing M8. Satin nickel.

Haustürknoopf fest mit durchgehender Befestigung M8. Nickel matt.

Bouton d'entrée fixe grande. Fixation traversante. M8. Nicklé mat.

Accessoires

Accessories

Zubehör



0099.997470

Schroefdraad met rvs eindkap t.b.v. bevestiging voordeurknop. 304 RVS geborsteld.

Change spindle for front door knob. including a cover plate. 304 brushed stainless steel.



Gewindestift mit Hutmutter für Haustürknoopf. Edelstahl 304 gebürstet.

Fixation traversante pour bouton d'entrée. Inox mat AISI 304.



0019.397500

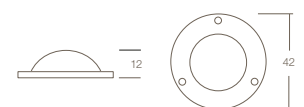

Afdekplaatje t.b.v. bout. Nikkel mat.

Bolt cover plate. Satin nickel.

Abdeckplatte für Bolzen. Nickel matt.

Ce cache boulon couvre la vis du bouton. Nicklé mat.

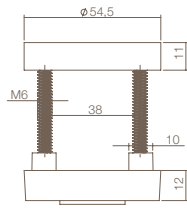

0019.375100

M6

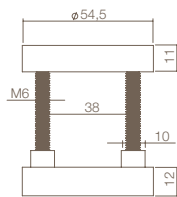
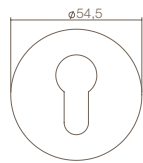

0019.375060

M6

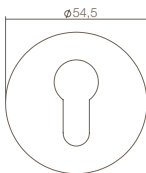

3751

0019.375100

PC veiligheidsrozet rond verdekt met kerntrek-beveiliging M6. Nikkel mat.



Security euro profile cylinder escutcheon round with cylinder protection. With invisible fixing M6. Satin nickel.

PZ Schutzrosette verdeckt Rund mit Kernziehschutz M6. Nickel matt.

Entrée de cylindre de haute sécurité avec cache anti-forage. Fixation invisible M6. Nicklé mat.



3750

0019.375060

PC veiligheidsrozet rond verdekt. M6. Nikkel mat.



Security euro profile cylinder escutcheon round. With invisible fixing M6. Satin nickel

PZ Schutzrosette Rund verdeckt. M6. Nickel matt.

Entrée de cylindre de sécurité. Fixation invisible M6. Nicklé mat.



3751

0019.375130

Afde krozet binnenzijde rond. Nikkel mat.



Euro profile cylinder escutcheon round. Satin nickel.

Schutzrosette Rund. Nickel matt.

Cache rosace. Couvre la cylindre de haute sécurité à l'intérieur. Nicklé mat.

Accessoires

Accessories
Zubehör



0099.990120	M6	70mm	58 - 64
0099.990122	M6	80mm	68 - 74
0099.990121	M6	90mm	78 - 84

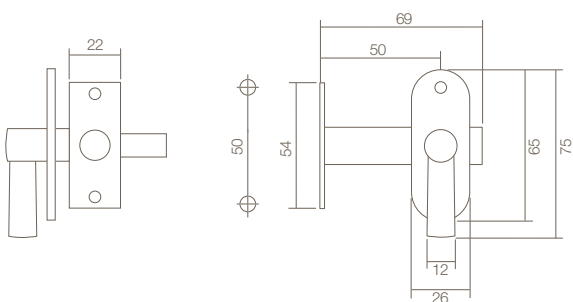
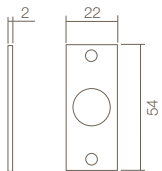
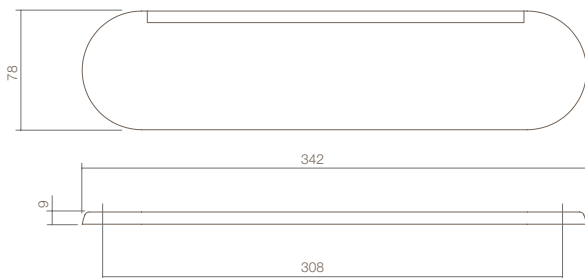
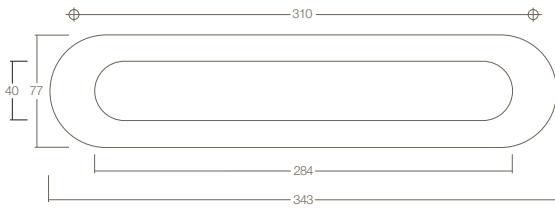

4000



- 0019.400005** Briefplaat ovaal met veer. Nikkel mat.
 Springloaded oval letter plate. Satin nickel.
 Briefeinwurf oval mit Feder. Nickel matt.
 Plaque-à-lettres ovale avec ressort. Nicklé mat.



4015



- 0019.401500** Tochtwering ovaal met borstel en afdekklep verdekt. Nikkel mat.
 Oval draught flap with brush and rain edge. Satin nickel.
 Zugklappe oval mit Bürstenleiste und Abdeckklappe verdeckt. Nickel matt.
 Plaque-à-lettres anti courants d'air, ovale, avec clapet. Nicklé mat.



4055



- 0019.405525** Insteekgrendel. Nikkel mat.
 Mortise latch. Satin nickel.
 Einsteck-Verriegelung. Nickel matt.
 Verrou à larder. Nicklé mat.



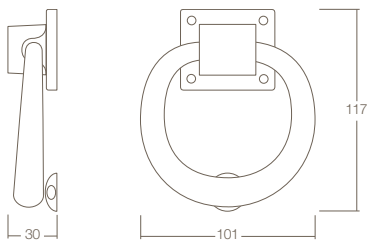
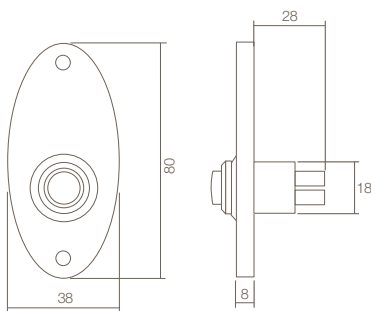
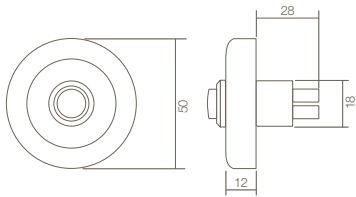
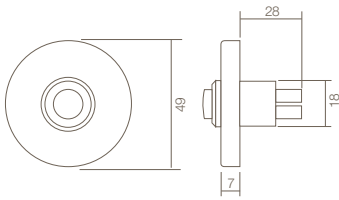

3990

0019.399027

Beldrukker rond verdekt. Nikkel mat.



Round concealed bell push. Satin nickel.

Klingelplatte rond verdeekt. Nickel matt.

Sonnette ronde. Fixation invisible. Nicklé mat.



3990

0019.399031

Beldrukker rond verdekt met rand. Nikkel mat.



Concealed round bell push. Satin nickel.

Klingelplatte rond verdeekt. Nickel matt.

Sonnette rond avec bord. Fixation invisible. Nicklé mat.



3990

0019.399028

Beldrukker ellips. Nikkel mat.



Bell push ellipse. Satin nickel.

Klingelplatte Ellipse. Nickel matt.

Sonnette Ellipse. Nicklé mat.



4035

0019.403500

Deurklopper rond. Nikkel mat.



Doorknocker round. Satin nickel.

Türklopper Rund. Nickel matt.

Heurtoir de porte rond. Nicklé mat.

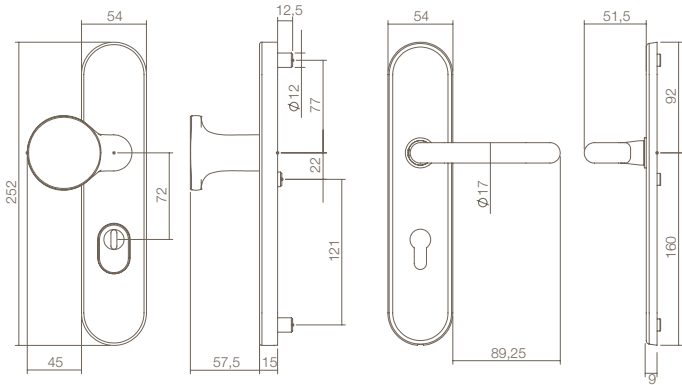

0019.382036 | | 72mm

0019.382049 | | 92mm

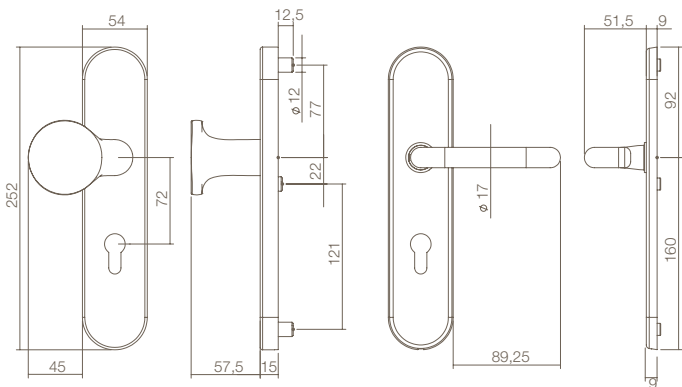

0019.384629 | | 55mm

0019.384636 | | 72mm

0019.384649 | | 92mm



3820

0019.382036

Veiligheidschilden met kerntrekbeveiliging greep/kruk los. Krukhals \varnothing 18mm. Links of rechts te monteren. Stift M14 x 8 x 75mm. Nikkel mat.



Security plates pull/lever with cylinder protection. Pull is reversible. Insert \varnothing 18mm. Spindle M14 x 8 x 75mm. Satin nickel.

Sicherheitsgarnitur Drücker/Griffplatte mit Kernziehschutz. Rechts/links verwendbar. Drücker Hals \varnothing 18mm. Stift M14 x 8 x 75mm. Nickel matt.

Garnitures de sécurité avec cache anti-forage et tirant fixe. Tirant réversible. Béquille seule, cou de \varnothing 18mm, droite ou gauche. Tige M14 x 8 x 75mm. Nickelé mat.



3846

0019.384629

Veiligheidschilden greep/kruk los. Krukhals \varnothing 18mm. Links of rechts te monteren. Stift M14 x 8 x 75mm. Nikkel mat.



Security plates pull/lever. Pull is reversible. Insert \varnothing 18mm. Spindle M14 x 8 x 75mm. Satin nickel.

Sicherheitsgarnitur Drücker/Griffplatte. Rechts/links verwendbar. Drücker Hals \varnothing 18mm. Stift M14 x 8 x 75mm. Nickel matt.

Garnitures de sécurité. Tirant réversible. Béquille seule, cou de \varnothing 18mm, droite ou gauche. Tige M14 x 8 x 75mm. Nickelé mat.

Accessoires

Accessories
Zubehör



0099.990120



M6

70mm



58 - 64

0099.990122

M6

80mm

68 - 74

0099.990121

M6

90mm

78 - 84



0099.975343



M14

□ 8x75mm

≤ 42

0099.975363

M14

□ 8x90mm

≤ 60

0099.975364

M14

□ 8x120mm

≤ 90

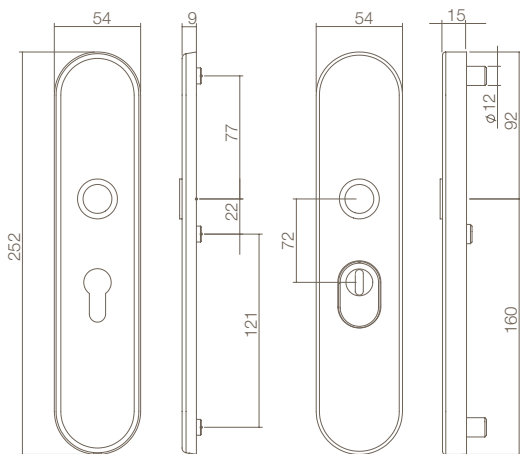

0019.382129		55mm
0019.382136		72mm

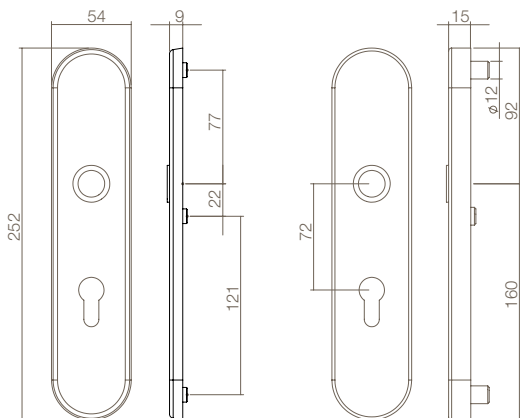

0019.381929		55mm
0019.381936		72mm
0019.381949		92mm



3821

0019.382136

Veiligheidsschilden doorgaand met kerntrek beveiliging. Krukhals \varnothing 18mm. Nikkel mat.



Security plates with cylinder protection. Insert \varnothing 18mm. Satin nickel.



Schutzbeschlag mit Kernziehschutz. Drücker Hals \varnothing 18mm. Nickel matt.



Garnitures de sécurité avec cache anti-forage. Béquille, cou de \varnothing 18mm (non fournie). Nicklé mat.



3819

0019.381929

Veiligheidsschilden doorgaand. Krukhals \varnothing 18mm. Nikkel mat.



Security plates. Insert \varnothing 18mm. Satin nickel.



Schutzbeschlag. Drücker Hals \varnothing 18mm. Nickel matt.



Garnitures de sécurité. Béquille, cou de \varnothing 18mm (non fournie). Nicklé mat.



Accessoires

Accessories
Zubehör



0099.990120		M6	70mm	58 - 64
0099.990122		M6	80mm	68 - 74
0099.990121		M6	90mm	78 - 84



0099.975000		\square 8x105mm	\leq 42
0099.975001		\square 8x120mm	\leq 58
0099.975002		\square 8x150mm	\leq 90



Nikkel mat - Satin nickel - Nickel matt - Nicklé mat

Buitendeurbeslag - Huiscijfers

0019

Exterior door hardware - House numbers

Außentürbeschläge - Hausnummern

Garnitures de porte extérieure - Numéros de maison



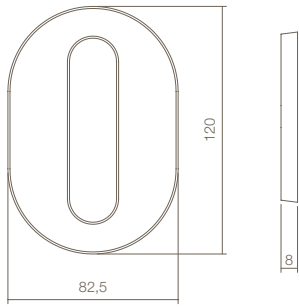

0019.402020	0	120mm
0019.402021	1	120mm
0019.402022	2	120mm
0019.402023	3	120mm
0019.402024	4	120mm
0019.402025	5	120mm
0019.402026	6	120mm
0019.402027	7	120mm
0019.402028	8	120mm
0019.402029	9	120mm



4020

0019.40202x

Huiscijfer 120mm. Inclusief bevestiging.
Nikkel mat.



House number 120mm. Including mounting
material. Satin nickel.

Hausnummer breit 120mm. inkl. Befestigung.
Nikkel matt.

Numéro de maison 120mm. Fixation fournie.
Nicklé mat.

0 1 2 3 4
5 6 7 8 9

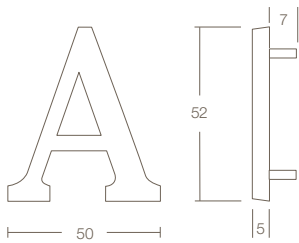

0019.402501	A	50mm
0019.402502	B	50mm
0019.402503	C	50mm



4025

0019.40250x

Huisletter. Inclusief bevestiging.
Nikkel mat.



House letter. Including mounting material.
Satin nickel.

Hausnummer inkl. Befestigung.
Nikkel matt.

Lettre de maison. Fixation fournie.
Nicklé mat.

A B C





Nikkel mat - Satin nickel - Nickel matt - Nicklé mat

Buitendeurbeslag - Vierkant

0019

Exterior door hardware - Square

Außentürbeschläge - Eckig

Garnitures de porte extérieure - Carrée

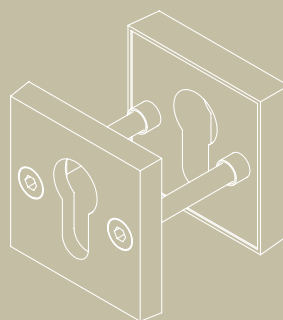

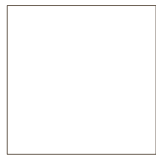
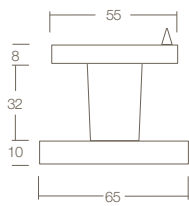

0019.393046

M8



3930

0019.393046

Voordeurknop vierkant vast centraal.
Doorgaande bevestiging M8. Nikkel mat.



Front door knob fixed centered.
Bolt through fixing M8. Satin nickel.



Haustürknoopf fest mittig mit durchgehender
Befestigung M8. Nickel matt.

Bouton d'entrée central fixe carrée.
Fixation traversante M8. Nicklé mat.

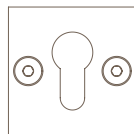
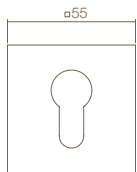

0019.375140

M6



3751

0019.375140

PC veiligheidsrozet massief vierkant.
Zichtbare bevestiging M6. Nikkel mat.



Square euro profile cylinder. With visible
fixing M6. Satin nickel.



PZ Schutzrosette eckig. Mit sichtbarer
Befestigung M6. Nickel matt.



Entrée de cylindre de sécurité massive carrée.
Fixation visible M6. Nicklé mat.

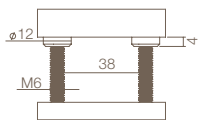

Accessoires

Accessories

Zubehör



0099.997470

Schroefdraad met rvs eindkap t.b.v. bevestiging voordeurknop.
304 RVS geborsteld.

Change spindle for front door knob, including a cover plate.
304 brushed stainless steel.

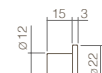
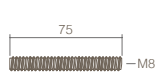

Gewindesttift mit Hutmutter für Haustürknoopf.
Edelstahl 304 gebürstet.

Fixation traversante pour bouton d'entrée.
Inox mat AISI 304.



0099.990120



0099.990122

M6

80mm

68 - 74

0099.990121

M6

90mm

78 - 84

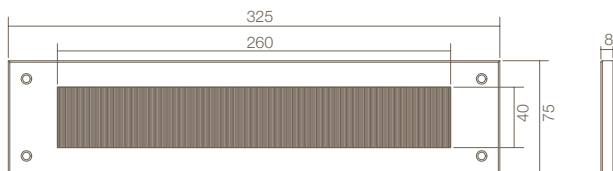
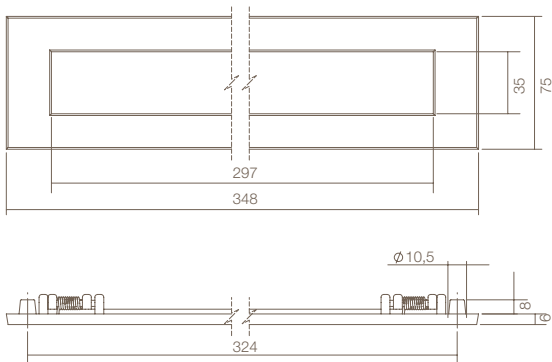
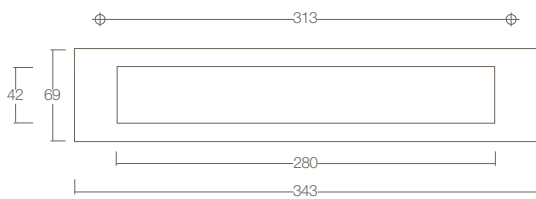
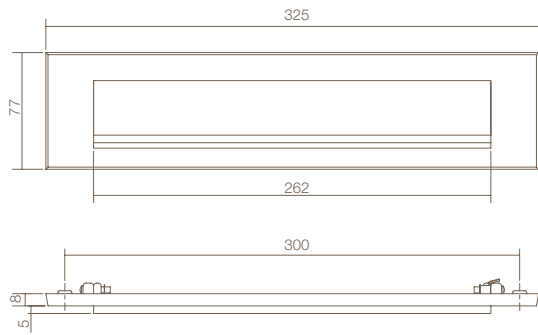

40001



0019.400001 Briefplaat rechthoekig met regenrand. Klep half naar buitendraaiend. Nikkel mat.



Letter plate square with rain edge, opens half outwards. Satin nickel.

Briefeinwurf rechteckig mit Tropfkante. Klappe halb nach außen öffnend. Nikkel matt.

Plaque-à-lettres rectangulaire. S'ouvrant à moitié vers l'extérieur. Nicklé mat.

40003



0019.400003 Briefplaat rechthoekig. Klep half naar buitendraaiend. Nikkel mat.



Letter plate square, opens half outwards. Satin nickel.

Briefeinwurf rechteckig. Klappe halb nach außen öffnend. Nikkel matt.

Plaque-à-lettres rectangulaire. S'ouvrant à moitié vers l'extérieur. Nicklé mat.

40004



0019.400004 Briefplaat rechthoekig met veer. Nikkel mat.



Square springloaded letter plate. Satin nickel.

Briefeinwurf rechteckig. Mit feder. Nikkel matt.

Plaque-à-lettres rectangulaire avec ressort. Nicklé mat.

4015



0019.401503 Tochtwering rechthoek met borstel. Nikkel mat.



Draught flap rectangular with brush. Satin nickel.

Zugklappe rechteckig mit Bürstenleiste. Nikkel matt.

Plaque-à-lettres rectangulaire anti courants d'air avec brosse. Nicklé mat.

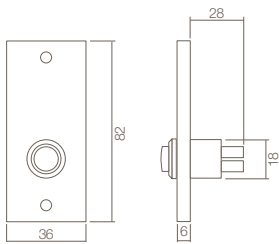
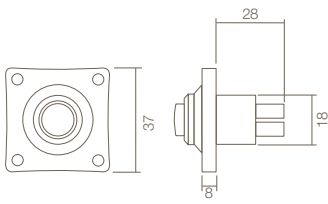

3990

0019.399029

Beldrukker vierkant klein. Nikkel mat.



Square bell push. Satin nickel.

Klingelplatte eckig. Nickel matt.

Sonnette carrée petite. Nicklé mat.



3990

0019.399032

Beldrukker rechthoekig. Nikkel mat.



Square bell push. Satin nickel.

Klingelplatte eckig. Nickel matt.

Sonnette rectangulaire. Nicklé mat.

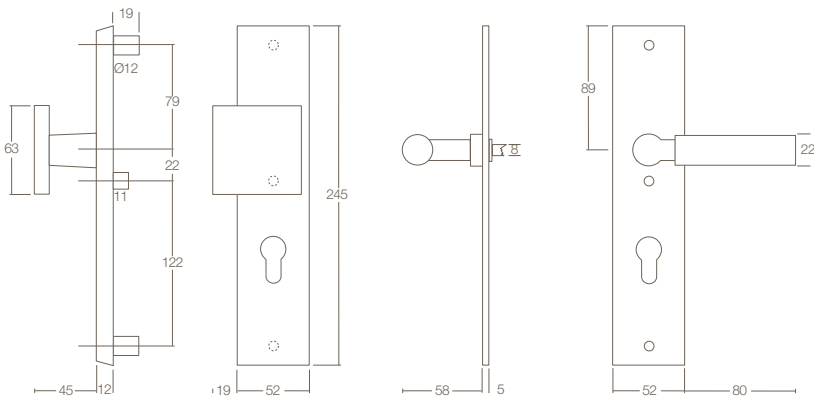

0019.382429		55mm
0019.382436		72mm
0019.382449		92mm



3824

0019.382429

Veiligheidschilden rechthoekig massief.
Stift M14x8x75mm. Greep/kruk. Nikkel mat.



Security plates escutcheon Spindle M14x8x75mm.
Pull/lever. Satin nickel.

Sicherheitsgarnitur auf Langschild
Stift M14x8x75mm. Drücker/Griffplatte. Nikkel matt.

Garniture de sécurité rectangulaire.
Tige M14x8x75mm. Avec béquille Bau-Stil.
Nicklé mat.

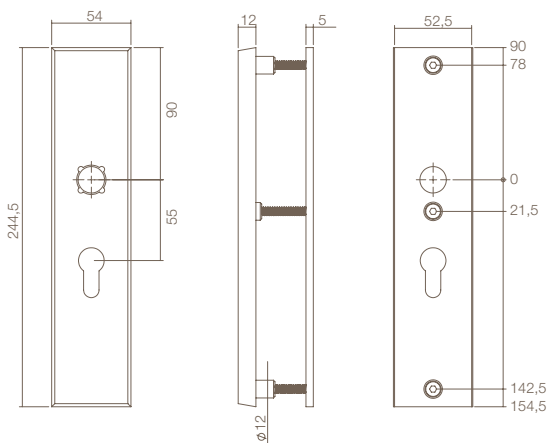

0019.382529		55mm
0019.382536		72mm



3825

0019.382529

Veiligheidschilden rechthoekig. Massief.
Krukhals ø18mm. Nikkel mat.



Security plates escutcheon. Insert ø18mm.
Satin nickel.

Sicherheitsgarnitur Langschild.
Drücker Hals ø18mm. Nikkel matt.

Garniture de sécurité rectangulaire.
Béquille, cou de ø18mm. Nicklé mat.

Accessoires

Accessories
Zubehör



0099.990120	M6	70mm	58 - 64
0099.990122	M6	80mm	68 - 74
0099.990121	M6	90mm	78 - 84



0099.975343	M14	□ 8x75mm	≤ 42
0099.975363	M14	□ 8x90mm	≤ 60
0099.975364	M14	□ 8x120mm	≤ 90



0099.975000	□ 8x105mm	≤ 42
0099.975001	□ 8x120mm	≤ 58
0099.975002	□ 8x150mm	≤ 90



Nikkel mat - Satin nickel - Nickel matt - Nicklé mat

Raambeslag - Raamsluitingen

0019

Window fittings - Window closers

Fensterbeschläge - Fenstersicherung

Garnitures de fenêtres - Béquilles de fenêtre

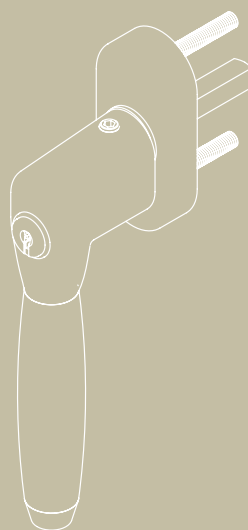

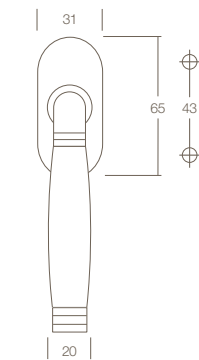
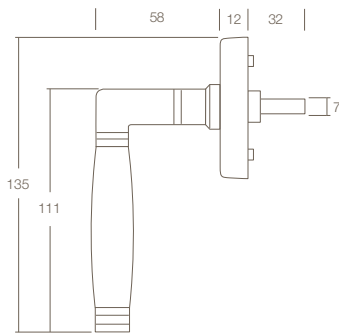
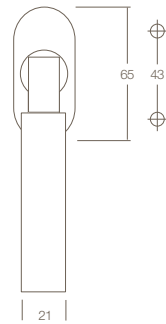
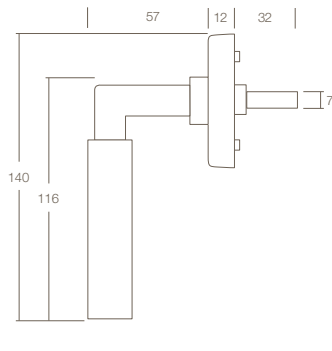
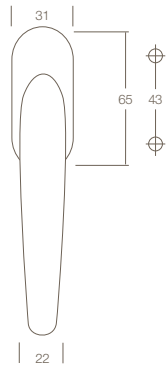
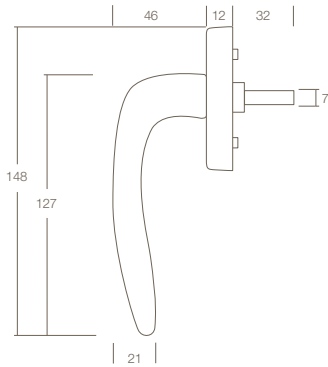

6050

0019.605020

Raamkruk ellips. Nikkel mat.



Window handle ellipse. Satin nickel.

Fenstergriff Ellips. Nickel matt.

Béquille de fenêtre Ellipse. Nicklé mat.



6050

0019.605090

Raamkruk Bau-stil. Nikkel mat.



Window handle Bau-stil. Satin nickel.

Fenstergriff Bau-stil. Nickel matt.

Béquille de fenêtre Bau-stil. Nicklé mat.



6051

0019.605190

Raamkruk Ton 222. nikkell mat/ebbenhout.



Window handle Ton 222. Satin nickel/ebony.

Fenstergriff Ton 400. 222. Nickel matt/Ebenholz.

Béquille de fenêtre Ton 222.

Nicklé mat/bois d'ébène.

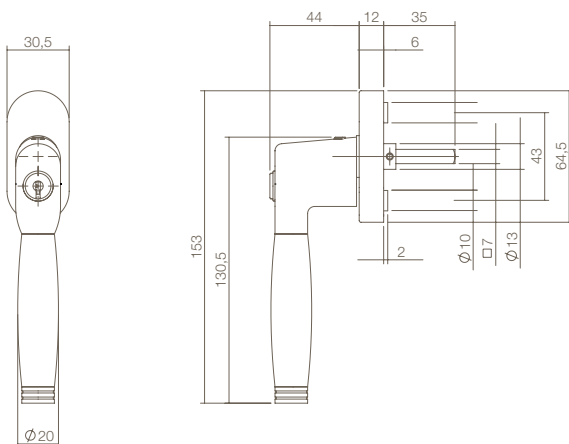
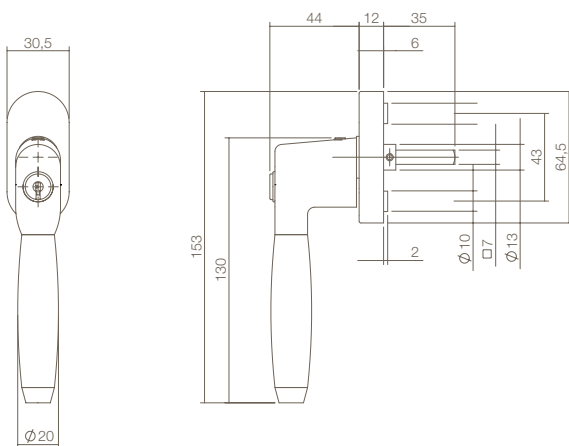
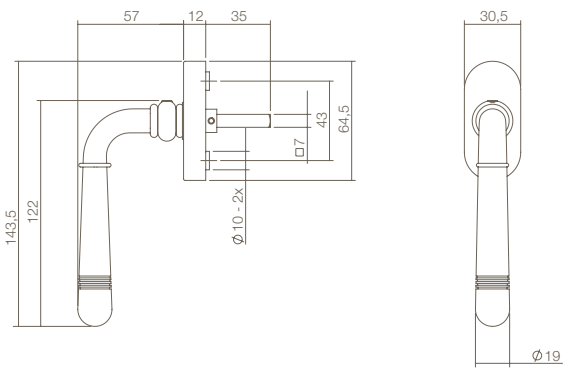

6170

0019.617050

Raamkruk Emily. Nikkel mat.



Window handle Emily. Satin nickel.

Fenstergriff Emily. Nickel matt.

Béquille de fenêtre Emily. Nicklé mat.



6616

0019.661645

Raamkruk Ton 400 afsluitbaar op ovaal rozet. Nikkel mat/ebbenhout.



Lockable window handle Ton 400 on oval rose. Satin nickel/ebony

Fenstergriff Ton 400 Abschließbar auf ovaler Rosette. Nickel matt/Ebenholz.

Béquille de fenêtre Ton 400 verrouillable sur rosace ovale. Nicklé mat/bois d'ébène.



6616

0019.661646

Raamkruk Ton 222. afsluitbaar op ovaal rozet. Nikkel mat/ebbenhout.



Lockable window handle Ton 222 on oval rose. Satin nickel/ebony.

Fenstergriff Ton 222. Abschließbar auf ovaler Rosette. Nickel matt/Ebenholz.

Béquille de fenêtre Ton 222. Verrouillable sur rosace ovale. Nicklé mat/bois d'ébène.

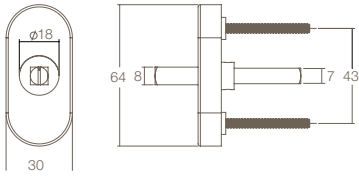

6050

0019.605000

Onderconstructie tbv raamkruk met hals
 ø18mm. nikkel mat.



Baseplate for window handle with a ø18mm
 insert. Satin nickel.

Unterkonstruktion für Fenstergriffe mit
 ø18mm Drückerhals. Nickel matt.

Sous-construction pour bécuille de fenêtre
 cou ø18mm. Nicklé mat.

Optie: Te combineren met deurkrukken op pagina
 154 - 158.

Option: Combine with doorhandles from page
 154 - 158.

Option: Zu kombinieren mit Türdrücker auf
 Seite 154 - 158.

Option: Une combinaison possible avec les béquilles
 de la page 154 - 158.

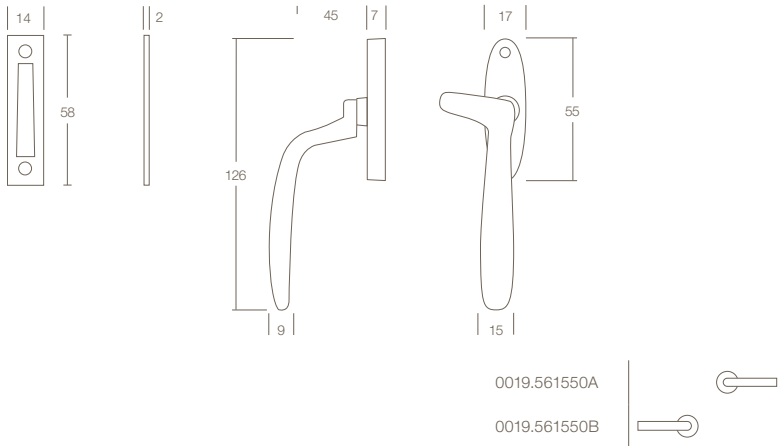

561550

0019.561550A Raamsluiting Dudok, rechts. Nikkel mat.



Window closer Dudok, right. Satin nickel.

Fenstersicherung Dudok, rechts. Nikkel matt.

Crémone Dudok, droite. Nicklé mat.

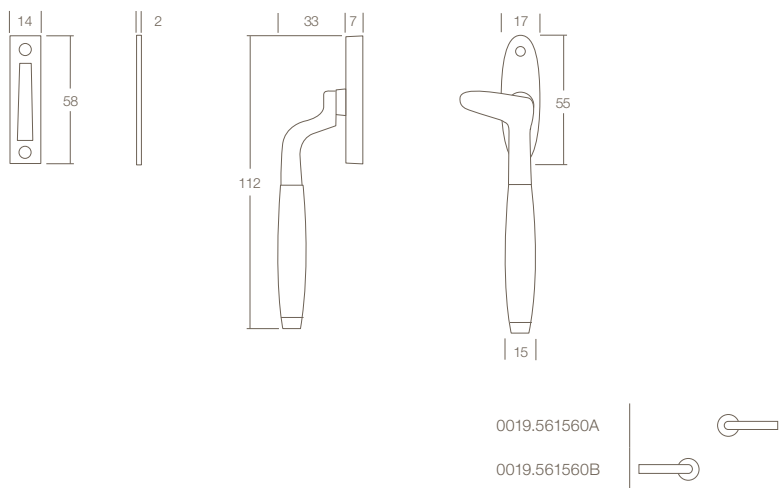

561560

0019.561560A Raamsluiting, rechts. Nikkel mat/zwart hout.



Window closer, right. Satin nickel/black wood.

Fenstersicherung, rechts.
Nickel matt/Schwarzes Holz.

Crémone, droite. Nicklé mat/bois noir.

Accessoires

Accessories
Zubehör



0019.561540

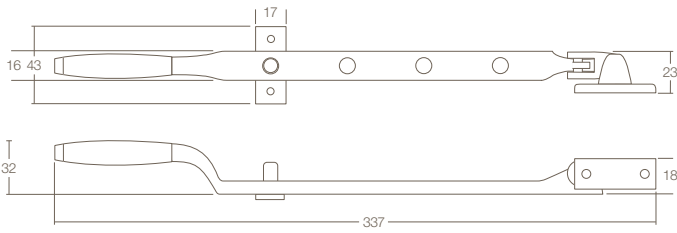

561580

0019.561580 Raamuitzetter Dudok met stelpen. Nikkel mat.



Window casement stay Dudok.
With casement stay pin. Satin nickel.

Fensteraufsteller Dudok mit Stellstift. Nickel matt.

Entrebâilleur Dudok avec cheville de positionnement.
Nicklé mat.

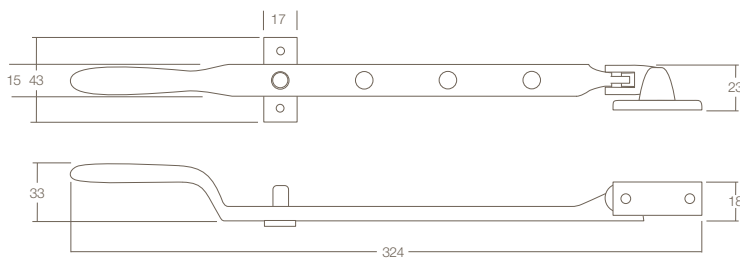

561581

0019.561581 Raamuitzetter met stelpen.
Nikkel mat/zwart hout.



Window casement stay. With casement stay pin.
Satin nickel/black wood.

Fensteraufsteller mit Stellstift.
Nickel mat/schwarzes Holz.

Entrebâilleur avec cheville de positionnement.
Nicklé mat/bois noir.

Accessoires

Accessories
Zubehör



0019.561589

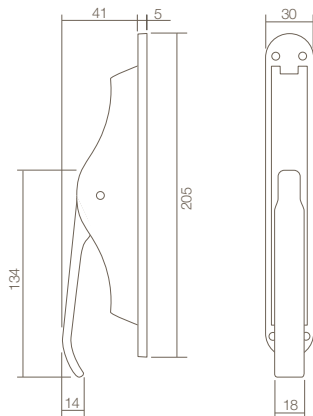
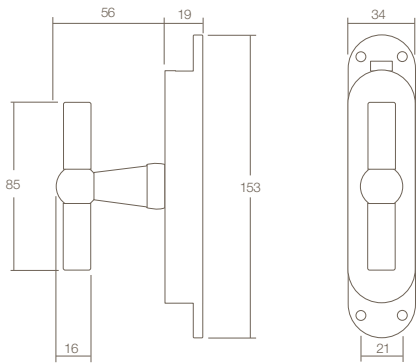

0019.562020

Espagnolet T-kruk. Nikkel mat.



Espagnolette T-model. Satin nickel.

Espagnolette T-Modell. Nickel matt.

Crémone kit "T". Nicklé mat.

5620



0019.562030

Pomp-espagnolet. nikkel mat.



Espagnolette. Satin nickel.

Espagnolette. Nickel matt.

Espagnolette à levier. Nicklé mat.

5620

Accessoires

Accessories
Zubehör



0019.562000



0019.562002

0019.562004
2 x 125cm0019.562007
2 x 125cm

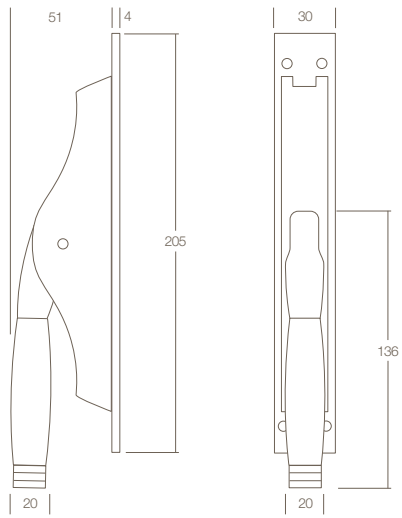

5620

0019.562035

Pomp-espagnolet Ton 222.
Nikkel mat/ebbenhout.



Espagnolette Ton 222. Satin nickel/ebony.

Espagnolette Ton 222.
Nikkel matt/Ebenholz.

Espagnolette à levier Ton 222.
Nicklé mat/bois d'ébène.

Accessoires

Accessories
Zubehör



0019.562000



0019.562002



0019.562004
2 x 125cm

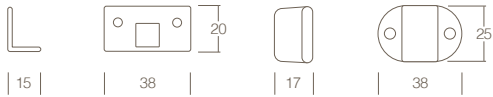
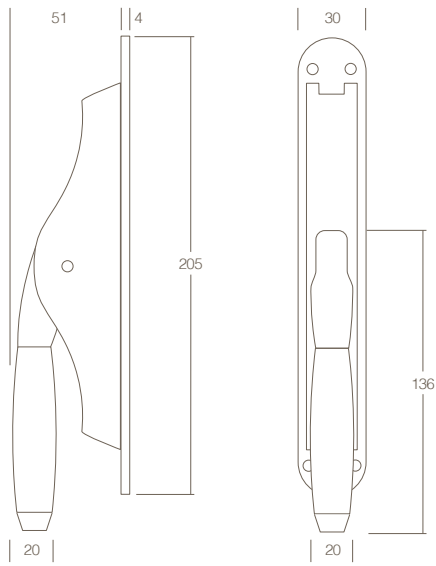

5620

0019.562036

Pomp-espagnolet Ton 400.
Nikkel mat/ebbenhout.



Espagnolette Ton 400.
Satin nickel/ebony.

Espagnolette Ton 400.
Nikkel matt/Ebenholz.

Espagnolette à levier Ton 400.
Nicklé mat/bois d'ébène.

Accessoires

Accessories
Zubehör



0019.562000



0019.562002



0019.562004
2 x 125cm

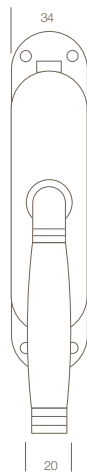
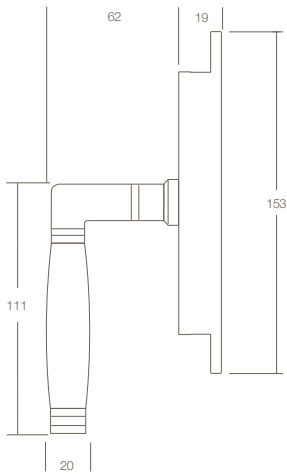

0019.562060A

0019.562060B

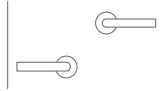

5620

0019.562060A

Kruk-espagnolet Ton 222, rechts.
Nikkel mat/ebbenhout.

Espagnolette Ton 222, right. Satin nickel/ebony.

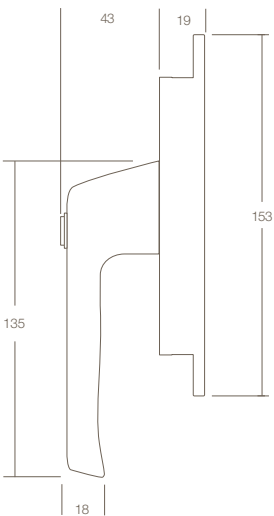
Espagnolette Ton 222, rechts.
Nikkel matt/Ebenholz.Crémone kit "Ton 222", droite.
Nicklé mat/bois d'ébène.

0019.562070A

0019.562070B

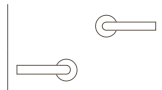

5620

0019.562070A

Afsluitbare kruk-espagnolet, rechts. Nikkel mat.



Lockable espagnolette, right. Satin nickel.

Espagnolette Abschließbar, rechts. Nickel matt.

Crémone kit "béquille verrouillable", droite.
Nicklé mat.

Accessoires

Accessories
Zubehör



0019.562000



0019.562002

0019.562007
2 x 125cm

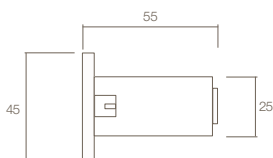
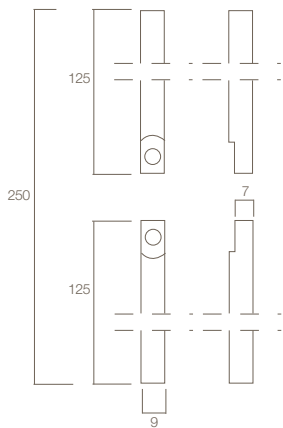
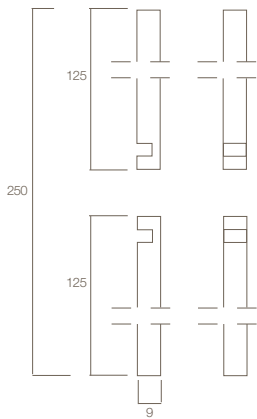

Accessoires

Accessories
Zubehör



0019.562000



0019.562001

562004



0019.562004

Stangenset tbv. **pomp-espagnolet**.
2 x 125cm. Nikkel mat.



Rods set for espagnolette. 2 x 125cm.
Satin nickel.

Stangen set für Espagnolette. 2 x 125cm.
Nickel matt.

Set tringles pour espagnolette à levier.
2 x 125cm. Nicklé mat.

562007



0019.562007

Stangenset tbv. **kruk-espagnolet**. 2 x 125cm.
Nikkel mat.



Rods set for Espagnolette. 2 x 125cm.
Satin nickel.

Stangen set für Espagnolette. 2 x 125cm.
Nickel matt.

Set tringles pour crémons. 2 x 125cm.
Nicklé mat.

562002



0019.562002

Espagnoletslot. Nikkel mat.



Espagnolette lock. Satin nickel.

Espagnolette Sperren. Nickel matt.

Verrou pour espagnolette. Nicklé mat.

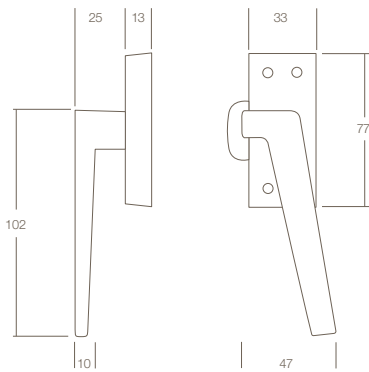

0019.561510A

0019.561510B

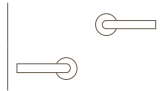
**561510****0019.561510A**

Raamsluiting met nok, rechts. Nikkel mat.



Window closer with lug, right. Satin nickel.

Fenstersicherung mit Stütznock, rechts. Nickel matt.

Béquille de fenêtre en applique, droite. Nicklé mat.

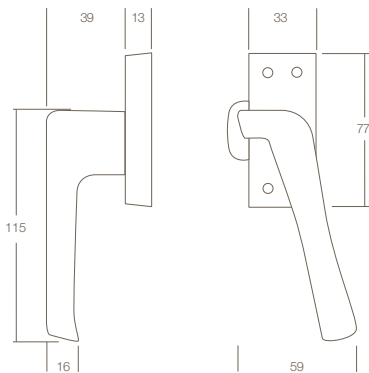

0019.561520A

0019.561520B

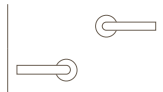
**561520****0019.561520A**

Raamsluiting met nok, rechts. Nikkel mat.



Window closer with lug, right. Satin nickel.

Fenstersicherung mit Stütznock, rechts. Nickel matt.

Béquille de fenêtre en applique, droite. Nicklé mat.

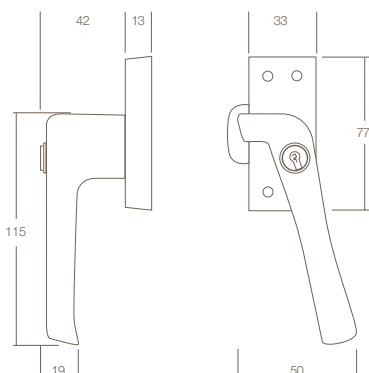

0019.561530A

0019.561530B

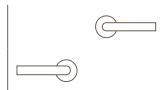
**561530****0019.561530A**

Afsluitbare raamsluiting met nok, rechts. Nikkel mat.



Lockable window closer with lug, right. Satin nickel.

Fenstersicherung. Abschließbar mit Stütznock, rechts. Nickel matt.

Béquille de fenêtre en applique verrouillable, droite. Nicklé mat.

Accessoires

Accessories
Zubehör



0019.561500

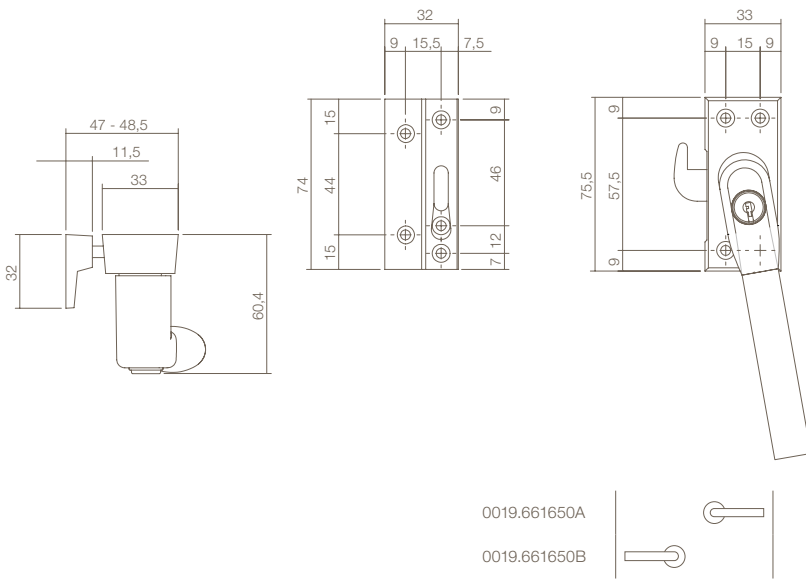

661650

0019.661650A Afsluitbare raamsluiting recht, rechts. Compleet Nikkel mat.



Lockable window closer straight, right. Complete Satin nickel.



Fenstersicherung. Abschließbar. Recht, rechts. Komplett. Nickel matt.

Béquille de fenêtre en applique verrouillable. Modèle droite. Complet. Nicklé mat.

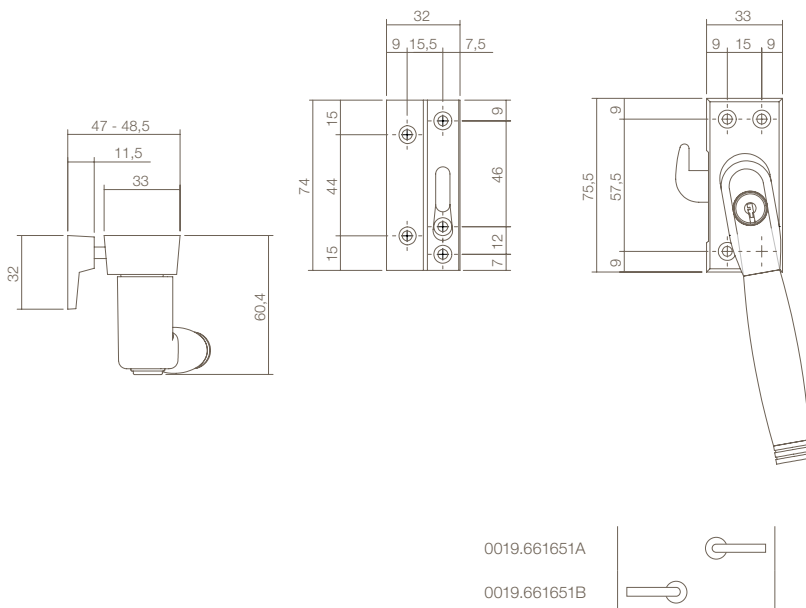

661651

0019.661651A Afsluitbare raamsluiting Ton 222, rechts. Compleet. Nikkel mat/ebbenhout.



Lockable window closer Ton 222, rechts. Complete. Satin nickel/ebony.



Fenstersicherung. Abschließbar. Ton 222, rechts. Komplett. Nickel matt/Ebenholz.

Béquille de fenêtre en applique verrouillable. Modèle Ton 222, droite. Complet. Nicklé mat/bois d'ébène.

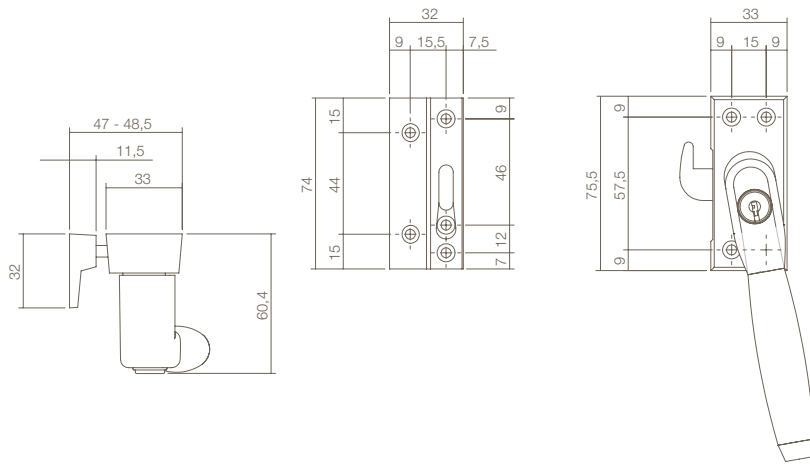

0019.661652A

0019.661652B

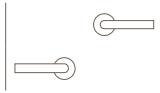

661652

0019.661652A Afsluitbare raamsluiting Ton 400, rechts. Compleet
Nikkel/ebenhout.



Lockable window closer Ton 400, right. Complete.
Nickel/ebony.



Fenstersicherung. Abschießbar. Ton 400, rechts.
Komplett. Nickel matt/Ebenholz.

Béquille de fenêtre en applique verrouillable.
Modèle Ton 400, droite. Complet.
Nicklé/bois d'ébène.

Nikkel mat - Satin nickel - Nickel matt - Nicklé mat

Toebehoren - Sierhulzen

0019

Accessories - Hinge covers

Zubehör - Übersteckhüls

Accessoires - Caches-paumelles



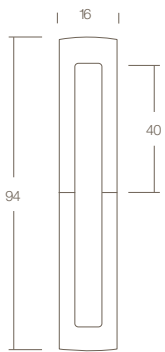

ø14mm



4540

0019.454000

Sierhuls stomp 40/40 voor paumel ø14mm.
Nikkel mat.



Decorative hinge cover blunt 40/40. Satin nickel.

Übersteckhüls Stumpf 40/40. Nickel matt.

Caches-paumelles modern 40/40 pour paumelles
ø14mm. Nicklé mat.

Nikkel mat - Satin nickel - Nickel matt - Nicklé mat

Toebehoren - Deurstoppers

0019

Accessories - Doorstops

Zubehör - Türstopper

Accessoires - Butoirs de porte

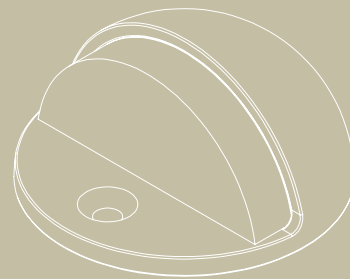

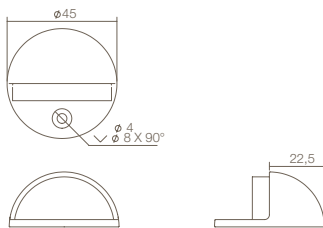
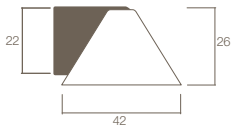
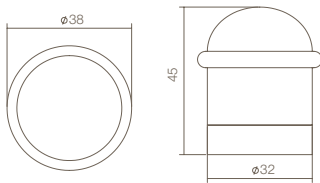

4420

0019.442000

Deurstop met ring. Nikkel mat.
Vloermontage.



Doorstop with ring. Satin nickel.
Floor mounting.

Türstopper mit Ring. Nickel matt.
Bodenmontage.

Butoir de porte avec bague. Nicklé mat.
Pose au sol.



4420

0019.442010

Deurstop taps. Nikkel mat.
Vloermontage.



Door stop conical. Satin nickel.
Floor mounting.

Türstopper Kegelförmig. Nickel matt.
Bodenmontage.

Butoir de porte conique. Nicklé mat.
Pose au sol.



4420

0019.442020

Deurstop rond model. Nikkel mat.
Vloermontage.



Doorstop round. Satin nickel.
Floor mounting.

Türstopper Rund. Nickel matt.
Bodenmontage.

Butoir de porte modèle rond. Nicklé mat.
Pose au sol.

Nikkel mat - Satin nickel - Nickel matt - Nicklé mat

Toebehoren - Garderobe

0019

Accessories - Coat rack

Zubehör - Garderoben

Accessoires - Porte-manteaux

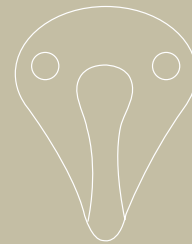

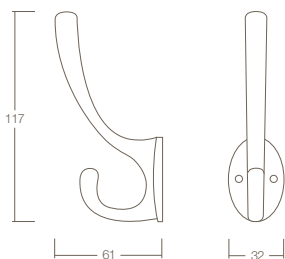
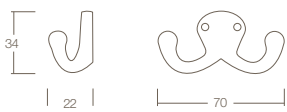
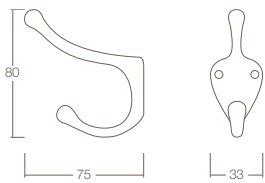
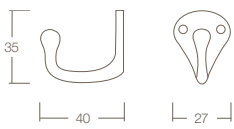
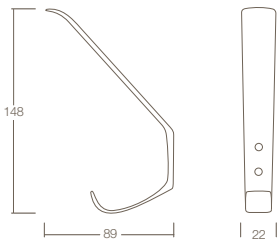

6926

0019.692600

Kapstokhaak 150mm. Nikkel mat.



Hat & coat hook 150mm. Satin nickel.

Kleiderhaken 150mm. Nickel matt.

Crochet porte-manteaux. Nicklé mat.



6926

0019.692611

Jashaak scheepsmodel. Nikkel mat



Coat hook. Satin nickel.

Mantelhaken. Nickel matt.

Crochet modèle bateau simple. Nicklé mat.



6926

0019.692612

Kapstokhaak scheepsmodel lang. Nikkel mat



Hat & coat hook. Satin nickel.

Kleiderhaken. Nickel matt.

Crochet porte-manteau modèle bateau. Nicklé mat.



6926

0019.692613

Kapstokhaak scheepsmodel dubbel. Nikkel mat



Hat & coat hook. Satin nickel.

Kleiderhaken. Nickel matt.

Crochet modèle bateau double. Nicklé mat.



6926

0019.692620

Kapstokhaak ovaal. Nikkel mat



Hat & coat hook oval. Satin nickel.

Kleiderhaken Oval. Nickel matt.

Crochet porte-manteau modèle ovale. Nicklé mat.

Nikkel mat - Satin nickel - Nickel matt - Nicklé mat

Toebehoren - Schuifdeurbeslag

0019

Accessories - Sliding door fittings

Zubehör - Schiebetürbeschläge

Accessoires - Ferrures de portes coulissantes

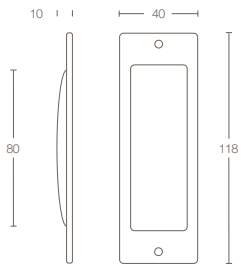

4476

0019.447600

Schuifdeurkom 120x40mm. Nikkel mat.



Flush pull 120x40mm. Satin nickel

Schiebetürmuschel 120x40mm. Nikkel matt.

Poignée cuvette à encastrer rectangulaire, montage par vis, 120x40mm. Nikkel mat.

Nikkel mat - Satin nickel - Nickel matt - Nicklé mat

Toebehoren - Deurgrepen

0019

Accessories - Pull handles

Zubehör - Stoßgriffe

Accessoires - Tirants

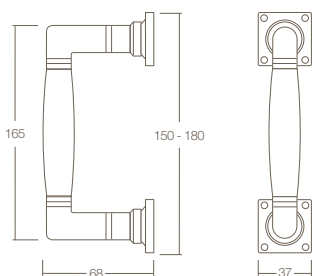
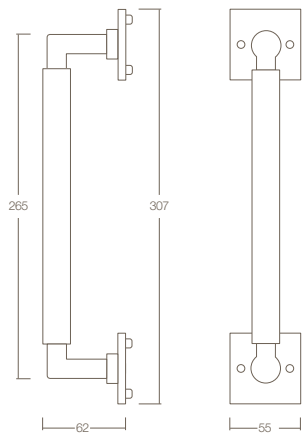
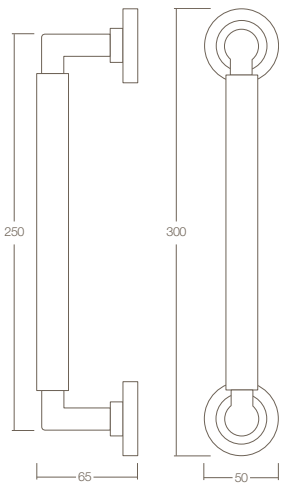

0019.426192	75/150mm
0019.426193	110/180mm



426180

0019.426180

Deurgreep Bau-Stil 250mm op rond rozet.
Eenzijdige bevestiging. Nikkel mat.



Pull handle Bau-Stil 250mm on round rose.
One side fixing. Satin nickel.

Stoßgriff Bau-Stil 250mm auf runder Rosette.
Einseitiger Befestigung. Nickel matt.

Tirant modèle Bau-Stil 250mm avec rosace ronde.
Montage unilatérale. Nicklé mat.



426190

0019.426190

Deurgreep Bau-Stil 250mm op vierkant rozet.
Eenzijdige bevestiging. Nikkel mat.



Pull handle Bau-Stil 250mm on square rose.
One side fixing. Satin nickel.

Stoßgriff Bau-Stil 250mm auf eckiger Rosette.
Einseitiger Befestigung. Nickel matt.

Tirant modèle Bau-Stil 250mm avec rosace
carrée. Montage unilatérale. Nicklé mat.



426192

0019.426193

Deurgreep Ton 110/180mm op vierkant rozet.
Eenzijdige bevestiging. Nikkel mat/ebbenhout.



Pull handle Ton 110/180mm on square rose.
One side fixing. Satin nickel/ebony.

Stoßgriff Ton 110/180mm auf eckiger Rosette.
Einseitiger Befestigung. Nickel matt/Ebenholz.

Tirant modèle Ton 110/180mm avec rosace
carrée. Montage unilatérale.
Nicklé mat/bois d' ébène.

Nikkel mat - Satin nickel - Nickel matt - Nickel mat

Toebehoren - Meubelgrepen

0019

Accessories - Furniture handles

Zubehör - Möbelgriffe

Accessoires - Poignées de meubles

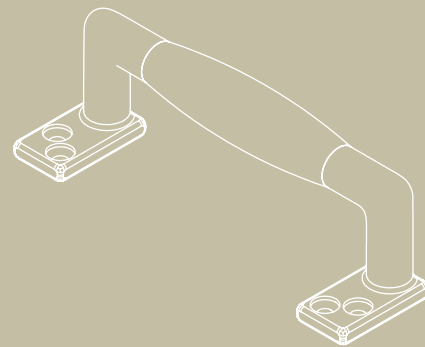

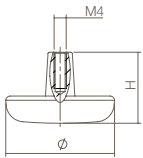

	Ø	H
0019.847600	28mm	22mm
0019.847601	36mm	23,5mm

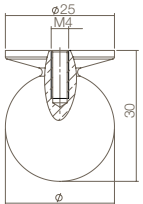
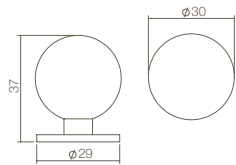

	Ø
0019.847661	20mm
0019.847662	25mm
0019.847663	30mm
0019.847664	35mm

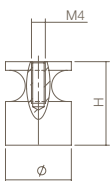

	Ø	H
0019.847700	16mm	20
0019.847701	19mm	24
0019.847702	25mm	32,5

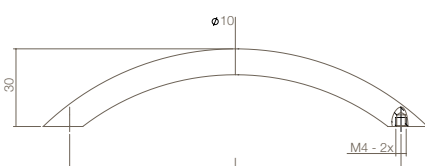

	Ø	L
0019.875040	10mm	96mm
0019.875041	10mm	128mm
0019.875042	10mm	160mm
0019.875043	10mm	192mm
0019.875045	10mm	288mm



847600

0019.847600 Knop plat. Nikkel mat.



Knob flat. Satin nickel

Knopf Flach. Nickel matt.

Bouton de meuble plat. Nicklé mat.



847610

0019.847610 Knop bol met plaat 30mm. Nikkel mat.



Knob sphere with plate 30mm. Satin nickel

Knopf Sphäre mit Platte 30mm. Nickel matt.

Bouton de meuble boule 30mm avec rosace. Nicklé mat.



847661

0019.847661 Knop bolrond. Nikkel mat.



Knob round. Satin nickel

Knopf Rund. Nickel matt.

Bouton de meuble boule avec rosace fixe. Nicklé mat.



847700

0019.847700 Knop rech. Nikkel mat.



Knob straight. Satin nickel

Knopf Rech. Nickel matt.

Bouton de meuble droit avec rosace fixe. Nicklé mat.



875040

0019.875040 Greep gebogen. Nikkel mat.



Handle bended. Satin nickel

Möbelgriff gebogen. Nickel matt.

Poignée de meuble courbe. Nicklé mat.

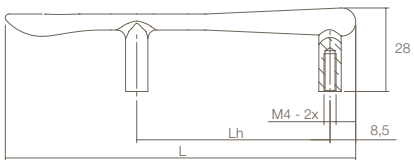
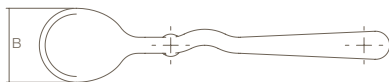
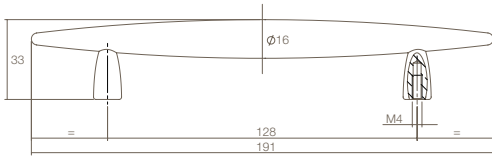

0019.875060

0019.875061

Lh

64mm

128mm

L

116mm

190mm

B

24,5

30,5

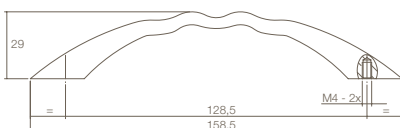
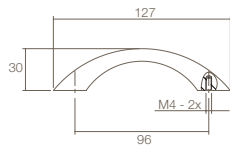
**875050****0019.875050**

Greep sigaar 128mm. Nikkel mat.



Grip cigar 128mm. Satin nickel

Möbelgriffe Zigarre 128mm. Nickel matt.

Poignée de meuble modèle Cigare. Nicklé mat.

**875060****0019.875060**

Greep lepel. Nikkel mat.



Grip spoon. Satin nickel

Möbelgriffe Löffel. Nickel matt.

Poignée de meuble modèle cuillère.
Nicklé mat.**875110****0019.875110**

Greep ellips 96/127mm. Nikkel mat.



Grip ellipse 96/127mm. Satin nickel

Möbelgriffe Ellipse 96/127mm. Nickel matt.

Poignée de meuble modèle Ellipse 96/127mm.
Nicklé mat.**875130****0019.875130**

Greep W-geribbeld 128mm. Nikkel mat.



Grip W twilled 128mm. Satin nickel

Möbelgriffe W Gerippt 128mm. Nickel matt.

Poignée de meuble modèle W 128mm.
Nicklé mat.

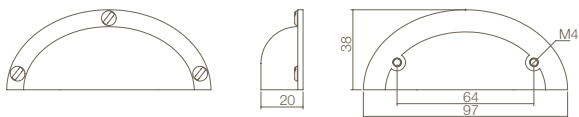
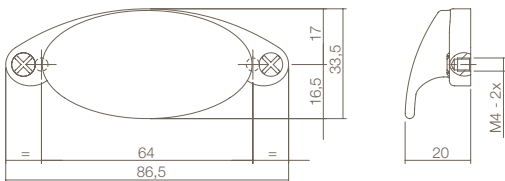
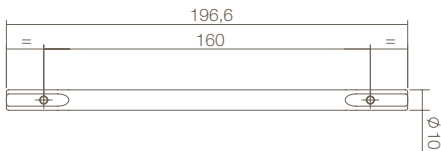
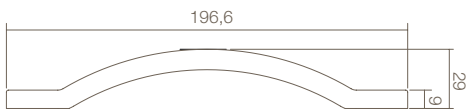
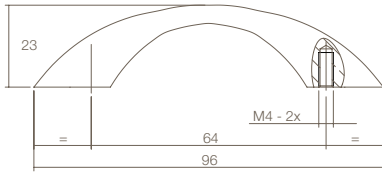

875140

0019.875140 Greep S-vormig. Nikkel mat.



Grip S model. Satin nickel.

Möbelgriffe S Form. Nickel matt.

Poignée de meuble modèle S. Nicklé mat.



875170

0019.875170 Greep gebogen ophliggend ø10/160mm. Nikkel mat.



Handle bended ø10/160mm. Satin nickel.

Möbelgriff ø10/160mm. Nickel matt.

Poignée de meuble courbe/droite ø10/160mm. Nicklé mat.



875240

0019.875240 Ladegreep klein. Nikkel mat.



Drawer handle small. Satin nickel.

Schublade Griff klein. Nickel matt.

Poignée de tiroir petit modèle. Nicklé mat.



875250

0019.875250 Komgreep 64/97mm. Nikkel mat.



Grip 64/97mm. Satin nickel.

Möbelgriff 64/97mm. Nickel matt.

Poignée Coquille 64/97mm. Nicklé mat.

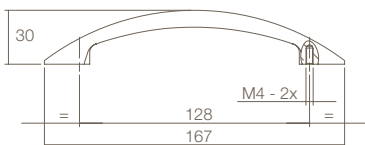
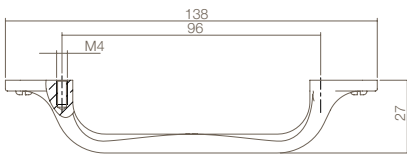
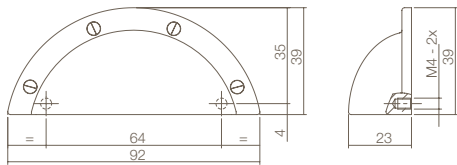
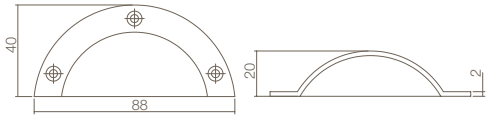

875260

0019.875260 Komgreep opschroevend. Nikkel mat.



Grip screw mounting. Satin nickel.

Möbelgriff schraubbar. Nickel matt.

Poignée Coquille avec trous de vis. Nicklé mat.



875270

0019.875270 Komgreep zwaar 64mm. Nikkel mat.



Grip 64mm. Satin nickel.

Möbelgriff 64mm.. Nickel matt.

Poignée Coquille massive 64mm. Nicklé mat.



875280

0019.875280 Handgreep kort 96mm. Nikkel mat.



Handle short 96mm. Satin nickel

Möbelgriff kurz 96mm. Nickel matt.

Poignée de meuble courte 96mm. Nicklé mat.



875300

0019.875300 Handgreep 128/167mm. Nikkel mat.



Grip 128/167mm. Satin nickel.

Möbelgriff 128/167mm. Nickel matt.

Poignée de meuble 128/167mm. Nicklé mat.

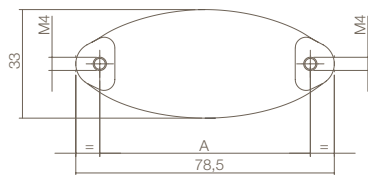
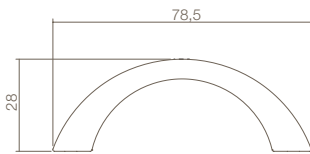
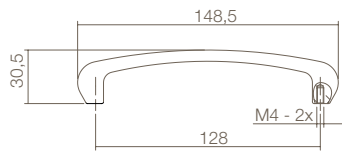

0019.875330
0019.875331

A
64mm
96mm

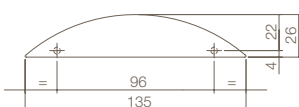
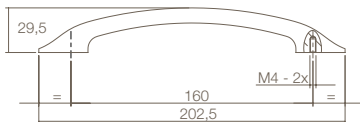

875310

0019.875310 Greep met bolle voet 128mm. Nikkel mat.



Grip with convex base 128mm. Satin nickel.

Möbelgriff mit konvexen Basis 128mm. Nickel matt.

Poignée de meuble avec une base convexe 128mm. Nicklé mat.



875330

0019.875330 Greep ellips breed. Nikkel mat.



Grip ellipse. Satin nickel.

Möbelgriff Ellipse. Nickel matt.

Poignée de meuble Ellipse. Nickel mat.



875350

0019.875350 Handgreep met ronde voet. Nikkel mat.



Drawer handle with round base. Satin nickel

Möbelgriff mit runde Basis. Nickel matt.

Poignée de meuble avec pied ronde. Nicklé mat.



875380

0019.875380 Ladegreep 96/135mm. Nikkel mat.



Drawer handle 96/135mm. Satin nickel

Schublade Griff 96/135mm. Nickel matt.

Poignée de tiroir 96/135mm. Nicklé mat.

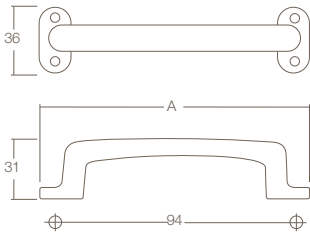

0019.561590
0019.561591

A
110mm
140mm

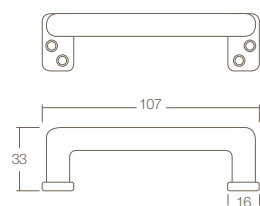
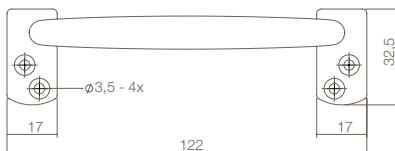
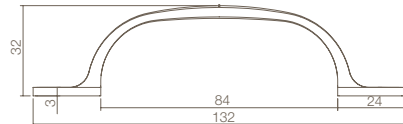

561590

0019.561590 Handgreep 777. Nikkel mat.
Handle 777. Satin nickel.
Möbelgriff 777. Nickel matt.
Poignée 777. Nicklé mat.



561600

0019.561600 Handgreep op vierkante voet 130mm. Nikkel mat.
Grip on square base 130mm. Satin nickel.
Möbelgriff mit eckiger Basis 130mm. Nickel matt.
Poignée base carrée. 130mm. Nicklé mat.



561601

0019.561601 Handgreep Haags model 122mm. Nikkel mat.
Grip 122mm. Satin nickel.
Möbelgriff 122mm. Nickel matt.
Poignée modèle La Haye 122mm. Nicklé mat.



561620

0019.561620 Handgreep recht 107mm. Nikkel mat.
Handle straight 107mm. Satin nickel.
Möbelgriff Recht 107mm. Nickel matt.
Poignée modèle droit 107mm. Nicklé mat.



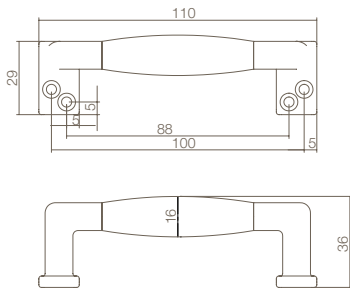

561640

0019.561640

Handgreep recht 110mm.
Nikkel mat/ebbenhout.



Handle straight 110mm. Satin nickel/ebony.

Möbelgriff Recht 110mm. Nickel matt/Ebenholz.

Poignée modèl droite 110mm.
Nicklé mat/bois d'ébène.

Nikkel mat - Satin nickel - Nickel matt - Nicklé mat

Toebehoren - Leuninghouders

0019

Accessories - Handrail brackets

Zubehör - Handlaufstützen

Accessoires - Supports de rampe

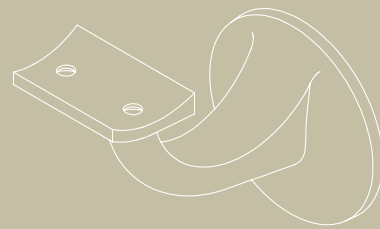

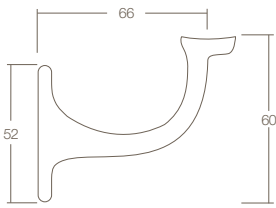

0019.724520

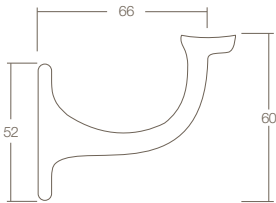

0019.724521



724520

0019.724520

Leuninghouder met schroefgaten. Vlak zadel.
Nikkel mat.



Handrail bracket screw mounting. Flat saddle.
Satin nickel.

Handlaufstütze schraubbar. Flach Sattel.
Nikkel matt.

Support de rampe. Plaque avec trous de vis.
Selle plate. Nicklé mat.



724521

0019.724521

Leuninghouder met schroefgaten. Hol zadel.
Nikkel mat.



Handrail bracket screw mounting. Hollow saddle.
Satin nickel.

Handlaufstütze, schraubbar. Hohl Sattel.
Nikkel matt.

Support de rampe. Plaque avec trous de vis.
Selle creuse. Nicklé mat.





Mat zwart - Satin black - Matt Schwarz - Noir mat

Binnendeurbeslag, vastdraaibaar - Rond

0023

Interior door hardware, springloaded - Round

Innentürbeschläge, Festdrehbar - Rund

Garnitures de porte intérieure, avec ressort - Ronde

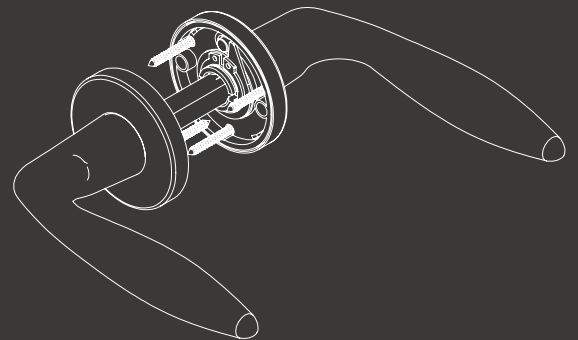

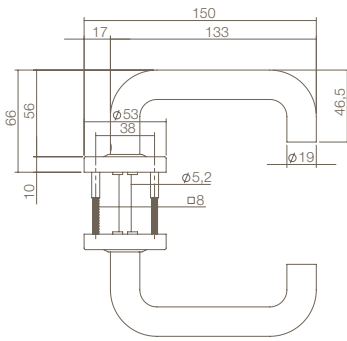

0023.057302



0023.057302A



0023.057302B

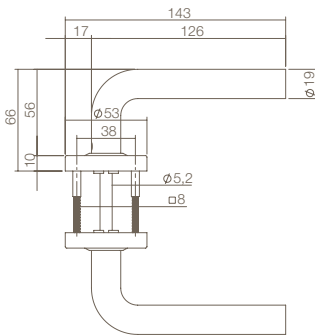

0023.057002



0023.057002A



0023.057002B

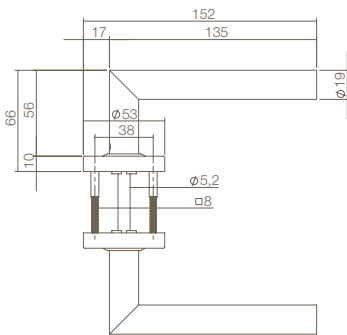

0023.058302



0023.058302A



0023.058302B

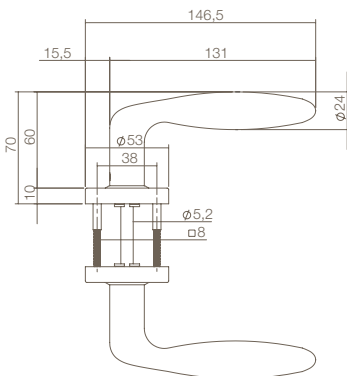

0023.058702



0023.058702A



0023.058702B



0573

0023.057302

Deurkruk Bern rond vastdraaibaar met dubbele veer op ronde rozet. RVS. Mat zwart.



Springloaded door handle Bern round on round rose. Stainless steel. Satin black.



Türdrücker Bern festdrehbar gelagert mit Feder auf runder Rosette. Edelstahl. Matt Schwarz.



Béquille Bern modèle U sertie sur rosace ronde avec double ressorts. Inox. Noir mat.



0570

0023.057002

Deurkruk Luzern recht vastdraaibaar met dubbele veer op ronde rozet. RVS. Mat zwart.



Straight springloaded door handle Luzern on round rose. Stainless steel. Satin black.



Türdrücker Luzern festdrehbar gelagert mit Feder recht auf runder Rosette. Edelstahl. Matt Schwarz.



Béquille Luzern modèle L sertie sur rosace ronde avec double ressorts. Inox. Noir mat.



0583

0023.058302

Deurkruk Jura hoek 90° vastdraaibaar met dubbele veer op ronde rozet. RVS. Mat zwart.



90° springloaded door handle Jura on round rose. Stainless steel. Satin black.



Türdrücker 90° Jura festdrehbar gelagert mit Feder auf runder Rosette. Edelstahl. Matt Schwarz.



Béquille Jura modèle L 90° sertie sur rosace ronde avec double ressorts. Inox. Noir mat.



0587

0023.058702

Deurkruk Jupiter vastdraaibaar met dubbele veer op ronde rozet. RVS. Mat zwart.



Springloaded door handle Jupiter on round rose. Stainless steel. Satin black.



Türdrücker Jupiter festdrehbar gelagert mit Feder auf runder Rosette. Edelstahl. Matt Schwarz.



Béquille Jupiter sertie sur rosace ronde avec double ressorts. Inox. Noir mat.

Accessoires

Accessories
Zubehör



0023.341016



0023.341017



0023.341019



0023.341060

8mm 

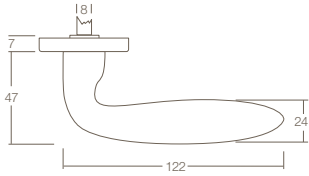
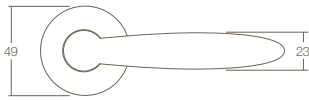

0023.019902

0023.019902A

0023.019902B

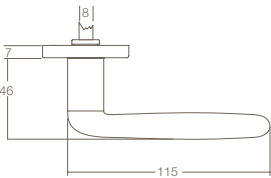
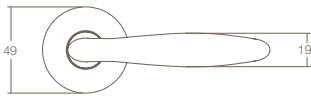
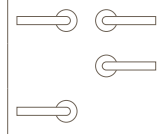

0023.020002

0023.020002A

0023.020002B

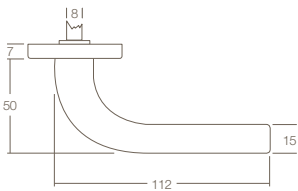
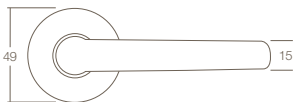
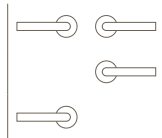

0023.023102

0023.023102A

0023.023102B

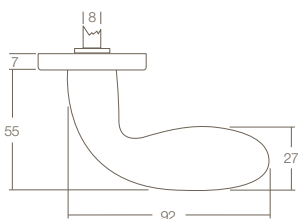
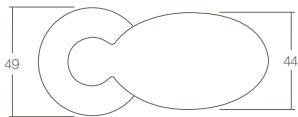
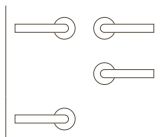

0023.026302

0023.026302A

0023.026302B

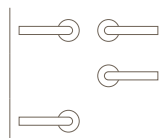

0199

0023.019902

Deurkruk Sigaar vastdraaibaar met veer op ronde rozet. Mat zwart.



Springloaded door handle cigar on round rose. Satin black.



Türdrücker Zigarre festdrehbar gelagert mit Feder auf runder Rosette. Matt Schwarz.

Béquille Sigare sertie sur rosace ronde avec ressort. Noir mat.



0200

0023.020002

Deurkruk Phobos vastdraaibaar met veer op ronde rozet. Mat zwart.



Springloaded door handle Phobos on round rose. Satin black.



Türdrücker Phobos festdrehbar gelagert mit Feder auf runder Rosette. Matt Schwarz.

Béquille Phobos sertie sur rosace ronde avec ressort. Noir mat.



0231

0023.023102

Deurkruk Elena vastdraaibaar met veer op ronde rozet. Mat zwart.



Springloaded door handle Elena on round rose. Satin black.



Türdrücker Elena festdrehbar gelagert mit Feder auf runder Rosette. Matt Schwarz.

Béquille Elena sertie sur rosace ronde avec ressort. Noir mat.



0263

0023.026302

Knopkruk Druppel vastdraaibaar met veer op ronde rozet. Mat zwart.



Springloaded door handle Drop on round rose. Satin black.



Türdrücker Tropf festdrehbar gelagert mit Feder auf runder Rosette. Matt Schwarz.

Béquille Bouton sertie sur rosace ronde avec ressort. Noir mat.

Accessoires

Accessories
Zubehör

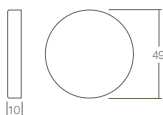

0023.318616



0023.318617



0023.318660



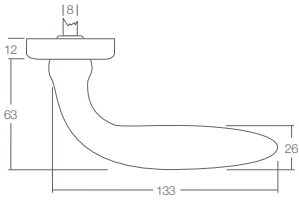
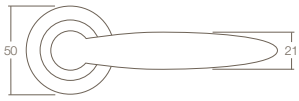

0023.020302



0023.020302A



0023.020302B



0203

0023.020302

Deurkruk Kuba vastdraaibaar met veer op ronde rozet. Mat zwart.



Springloaded door handle Kuba on round rose. Satin black.



Türdrücker Kuba festdrehbar gelagert mit Feder auf runder Rosette. Matt Schwarz.

Béquille Kuba sertie sur rosace ronde avec ressort. Noir mat.

Accessoires

Accessories
Zubehör



0023.316416



0023.316417



0023.316460



8mm 



Mat zwart - Satin black - Matt Schwarz - Noir mat

Binnendeurbeslag - Vierkant

0023

Interior door hardware - Square

Innentürbeschläge - Eckig

Garnitures de porte intérieure - Carrée

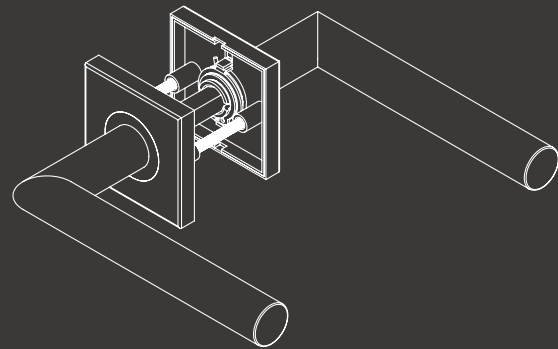

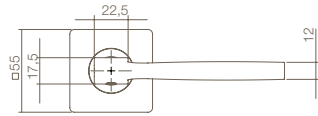
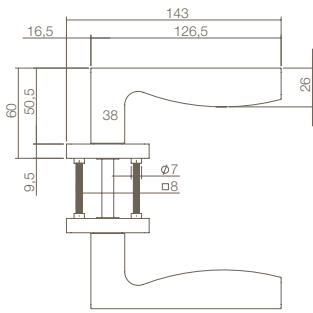

0023.171002

0023.171002A

0023.171002B

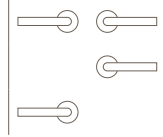

1710

0023.171002

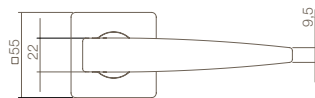
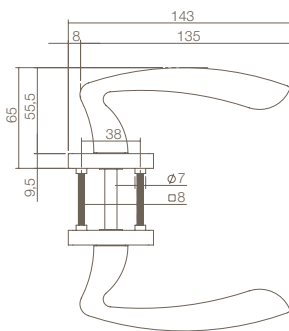
Deurkruk Apollo vastdraaibaar met veer op vierkant rozet. Nokken $\varnothing 7$ mm. Mat zwart.Springloaded door handle Apollo on square rose. Lugs $\varnothing 7$ mm. Satin black.Türdrücker Apollo festdrehbar gelagert mit Feder auf eckiger Rosette. Stütznocken $\varnothing 7$ mm. Matt Schwarz.Béquille Apollo sertie sur rosace carrée avec ressort. Tenons $\varnothing 7$ mm. Noir mat.

0023.171102

0023.171102A

0023.171102B

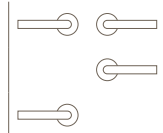

1711

0023.171102

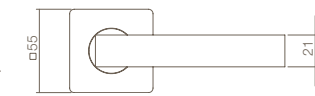
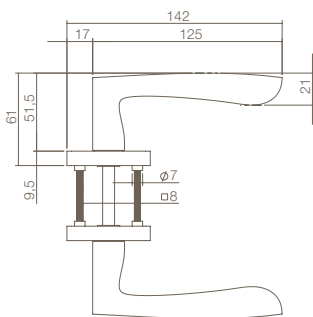
Deurkruk Zeus vastdraaibaar met veer op vierkant rozet. Nokken $\varnothing 7$ mm. Mat zwart.Springloaded door handle Zeus on square rose. Lugs $\varnothing 7$ mm. Satin black.Türdrücker Zeus festdrehbar gelagert mit Feder auf eckiger Rosette. Stütznocken $\varnothing 7$ mm. Matt Schwarz.Béquille Zeus sertie sur rosace carrée avec ressort. Tenons $\varnothing 7$ mm. Noir mat.

0023.171202

0023.171202A

0023.171202B

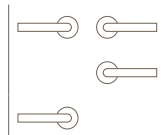

1712

0023.171202

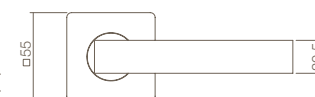
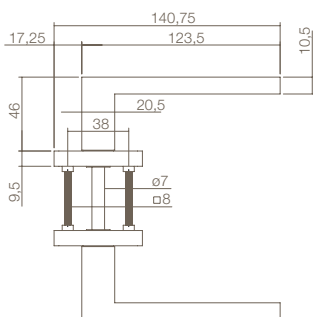
Deurkruk Minos vastdraaibaar met veer op vierkant rozet. Nokken $\varnothing 7$ mm. Mat zwart.Springloaded door handle Minos on square rose. Lugs $\varnothing 7$ mm. Satin black.Türdrücker Minos festdrehbar gelagert mit Feder auf eckiger Rosette. Stütznocken $\varnothing 7$ mm. Matt Schwarz.Béquille Minos sertie sur rosace carrée avec ressort. Tenons $\varnothing 7$ mm. Noir mat.

0023.171302

0023.171302A

0023.171302B

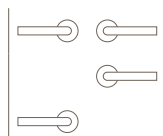

1713

0023.171302

Deurkruk Hera vastdraaibaar met veer op vierkant rozet. Nokken $\varnothing 7$ mm. Mat zwart.Springloaded door handle Hera on square rose. Lugs $\varnothing 7$ mm. Satin black.Türdrücker Hera festdrehbar gelagert mit Feder auf eckiger Rosette. Stütznocken $\varnothing 7$ mm. Matt Schwarz.Béquille Hera sertie sur rosace carrée avec ressort. Tenons $\varnothing 7$ mm. Noir mat.

Accessoires

Accessories
Zubehör

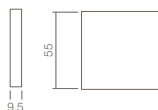

0023.318516



0023.318517



0023.318560



8mm

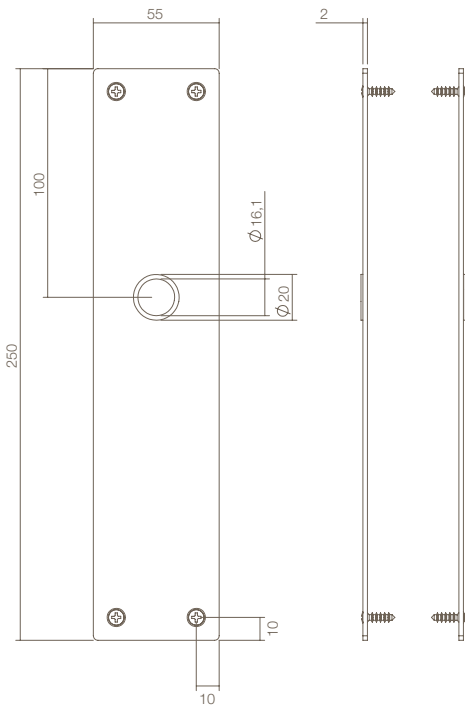

0023.268811		72mm
0023.268826		55mm
0023.268829		72mm
0023.268836		72mm
0023.268865		63/8mm

2688

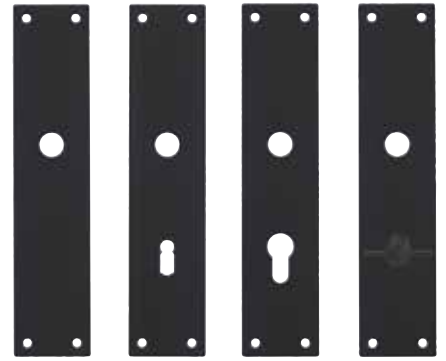
**0023.268811**

Renovatie schild rechthoekig voor krukken met krukhalshals $\varnothing 16\text{mm}$. RVS. Mat zwart. 250mm x 55mm x 2mm.



Renovationplate. For door handles with insert $\varnothing 16\text{mm}$. Stainless steel. Satin black. 250mm x 55mm x 2mm

Renovationslängschild eckig. Für Türdrücker mit Drücker Hals $\varnothing 16\text{mm}$. Edelstahl. Matt Schwarz. 250mm x 55mm x 2mm.

Plaque de renovation rectangulaire 250 x 55 x 2mm. Pour l'usage des béquilles avec cou de $\varnothing 16\text{mm}$. Inox. Noir mat.

Optie:

Te combineren met deurkrukken 0023.057300, 0023.057000, 0023.058300, 0023.058700, 0023.057100

Option:

Combine with doorhandles 0023.057300, 0023.057000, 0023.058300, 0023.058700, 0023.057100

Option:

Zu kombinieren mit Türdrücker 0023.057300, 0023.057000, 0023.058300, 0023.058700, 0023.057100

Option:

Combinaison avec les béquilles 0023.057300, 0023.057000, 0023.058300, 0023.058700, 0023.057100

**Bern** 0023.057300**Luzern** 0023.057000**Jura** 0023.058300**Jupiter** 0023.058700**Amsterdam** 0023.057100



Mat zwart - Satin black - Matt Schwarz - Noir mat

Binnendeurbeslag

0023

Losse krukken, schilden, rozetten en accessoires

Interior door hardware - Door handles, security plates, escutcheons and accessories

Innentürbeschläge - Türdrucker, Sicherheitsgarnituren, Rosetten und Zubehör

Garnitures de porte intérieure - Béquilles, Garnitures de sécurité, Entrée de cylindre et accessoires

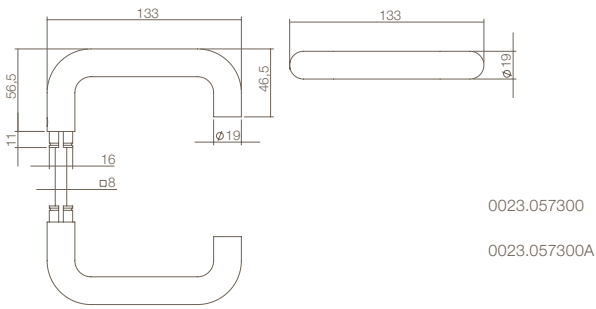

0023.057300

0023.057300A

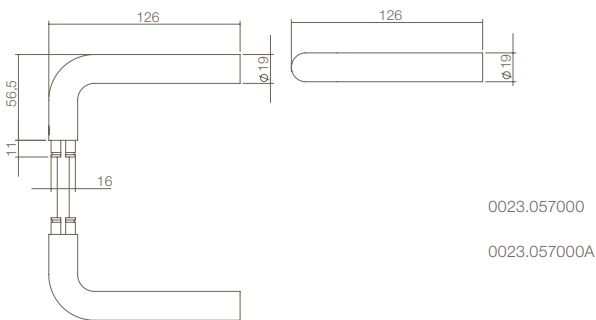
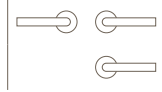

0023.057000

0023.057000A

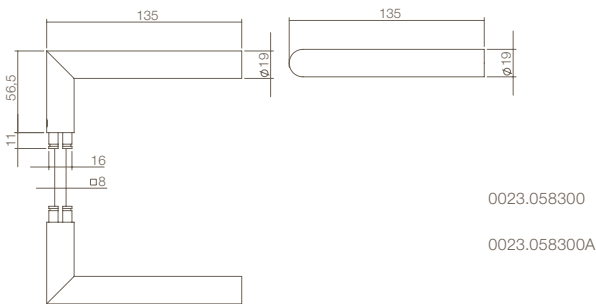
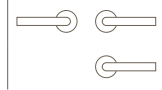

0023.058300

0023.058300A

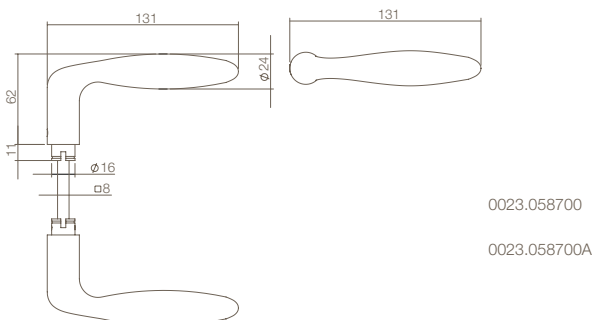
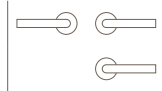

0023.058700

0023.058700A

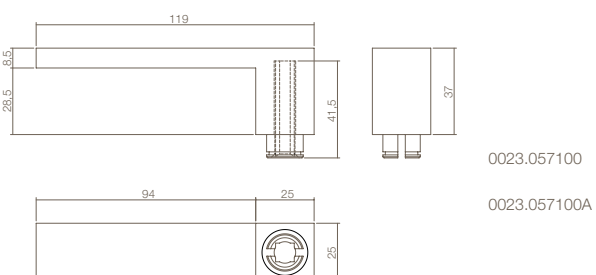
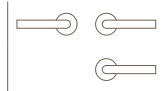

0023.057100

0023.057100A

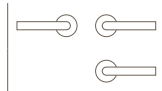

0573



0023.057300 Deurkruk Bern rond met krukhalshals ϕ 16mm.
RVS. Mat zwart.



Door handle Bern round. Insert ϕ 16mm.
Stainless steel. Satin black.

Türdrücker Bern Rund. Drücker Hals ϕ 16mm.
Edelstahl. Matt Schwarz.

Béquille Bern modèle U avec cou de ϕ 16mm.
Inox. Noir mat.

0570



0023.057000 Deurkruk Luzern recht met krukhalshals ϕ 16mm.
RVS. Mat zwart.



Door handle Luzern straight. Insert ϕ 16mm.
Stainless steel. Satin black.

Türdrücker Luzern recht. Drücker Hals ϕ 16mm.
Edelstahl. Matt Schwarz.

Béquille Luzern modèle L avec cou de ϕ 16mm.
Inox. Noir mat.

0583



0023.058300 Deurkruk Jura hoek 90° met krukhalshals ϕ 16mm.
RVS. Mat zwart.



90° door handle Jura. Insert ϕ 16mm.
Stainless steel. Satin black.

Türdrücker Jura 90°. Drücker Hals ϕ 16mm.
Edelstahl. Matt Schwarz.

Béquille Jura modèle L 90° avec cou de ϕ 16mm.
Inox. Noir mat.

0587



0023.058700 Deurkruk Jupiter met krukhalshals ϕ 16mm.
RVS. Mat zwart.



Door handle Jupiter. Insert ϕ 16mm.
Stainless steel. Satin black.

Türdrücker Jupiter. Drücker Hals ϕ 16mm.
Edelstahl. Matt Schwarz.

Béquille Jupiter avec cou de ϕ 16mm.
Inox. Noir mat.

0571



0023.057100 Deurkruk Amsterdam met krukhalshals ϕ 16mm.
RVS. Mat zwart.



Door handle Amsterdam. Insert ϕ 16mm.
Stainless steel. Satin black.

Türdrücker Amsterdam. Drücker Hals ϕ 16mm.
Edelstahl. Matt Schwarz.

Béquille Amsterdam avec cou de ϕ 16mm.
Inox. Noir mat.

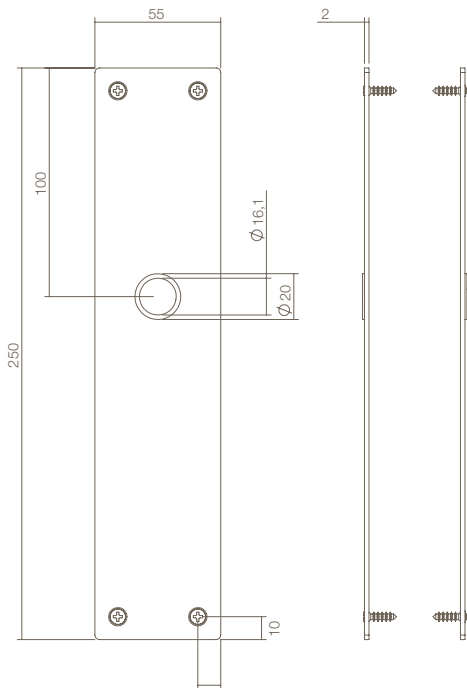
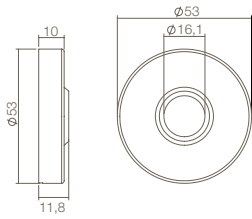

0023.268811		72mm
0023.268826		55mm
0023.268829		72mm
0023.268836		72mm
0023.268865		63/8mm



341004



0023.341004 Rond rozet verdekt. RVS. Mat zwart.



Round escutcheon. With visible fixing.
Stainless steel. Satin black.

Rosette rond. Verdeekt. Edelmetal. Matt Schwarz.

Rosace ronde. Fixation invisible. Inox. Noir mat.

2688

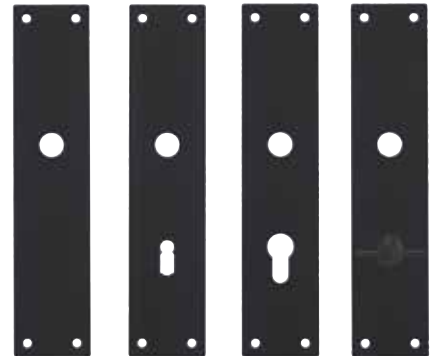

0023.268811 Renovatie schild rechthoekig voor krukken met krukhalshals \varnothing 16mm. RVS. Mat zwart. 250mm x 55mm x 2mm



Renovationplate. For door handles with Insert \varnothing 16mm. Stainless steel. Satin black. 250mm x 55mm x 2mm

Renovationslangschild eckig. Für Türdrücker mit Drücker Hals \varnothing 16mm. Edelmetal. Matt Schwarz. 250mm x 55mm x 2mm

Plaque de renovation rectangulaire. 250 x 55 x 2mm. Pour l'usage des béquilles avec cou de \varnothing 16mm. Inox. Noir mat.

Optie: Alleen te combineren met deurkrukken op vorige pagina.

Option: Only be combined with doorhandles from the previous page.

Option: Nur zu kombinieren mit Türdrücker auf der vorherigen Seite.

Option: Combinaison seulement possible avec les béquilles de la page précédente.

Accessoires

Accessories
Zubehör

Zelfklevend

Self-adhesive
Zum aufkleben
Auto-adhésif



0023.340304



0023.340316



0023.340317



0023.340319



0023.340357



0023.340360

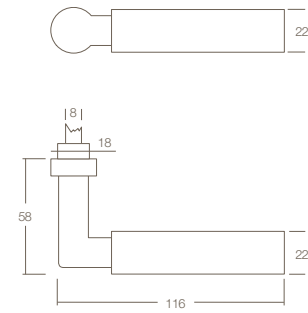

5mm

8mm



0023.037800		
0023.037800A		
0023.037800B		



0378

0023.037800 Deurkruk Bau-stil met krukhals ø18mm. Mat zwart.





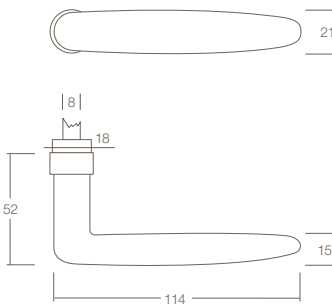

Door handle Bau-stil. Insert ø18mm. Satin black.

Türdrücker Bau-stil. Drücker Hals ø18mm. Matt Schwarz.

Béquille Bau-stil avec cou de ø18mm. Noir mat.



0023.022500		
0023.022500A		
0023.022500B		



0225

0023.022500 Deurkruk Sophie met krukhals ø18mm. Mat zwart.





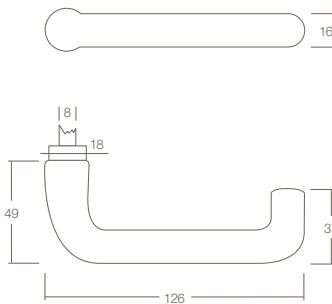

Door handle Sophie. Insert ø18mm. Satin black.

Türdrücker Sophie. Drücker Hals ø18mm. Matt Schwarz.

Béquille Sophie avec cou de ø18mm. Noir mat.



0023.023400		
0023.023400A		
0023.023400B		



0234

0023.023400 Deurkruk Rond met krukhals ø18mm. Mat zwart.





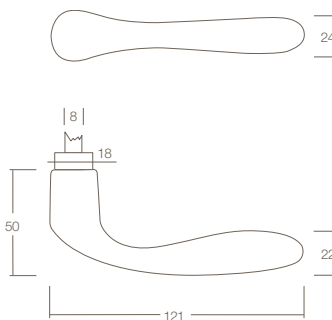

Door handle Round. Insert ø18mm. Satin black.

Türdrücker Rund. Drücker Hals ø18mm. Matt Schwarz.

Béquille modèle U avec cou de ø18mm. Noir mat.



0023.020100		
0023.020100A		
0023.020100B		



0201

0023.020100 Deurkruk Banaan met krukhals ø18mm. Mat zwart.



Door handle Banana. Insert ø18mm. Satin black.

Türdrücker Banane. Drücker Hals ø18mm. Matt Schwarz.

Béquille Banane avec cou de ø18mm. Noir mat.

Accessoires Accessories Zubehör



0023.317304 0023.317316 0023.317317 0023.317360 8mm



0023.318404 0023.318416 0023.318417 0023.318460 8mm 0023.318304 0023.318316 0023.318317 0023.318360 8mm

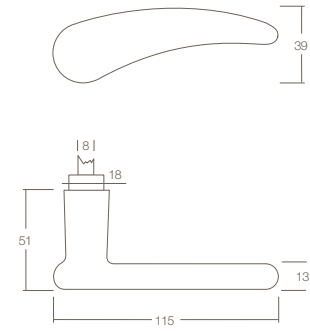

- 0023.029700
- 0023.029700A
- 0023.0297000B

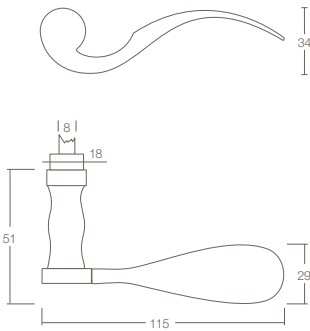

- 0023.029200
- 0023.029200A
- 0023.029200B

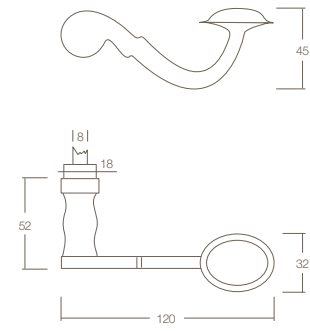

- 0023.029300
- 0023.029300A
- 0023.029300B

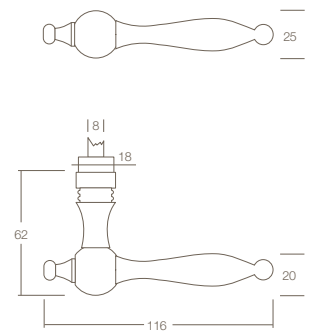

- 0023.031500
- 0023.031500A



0023.029700 Deurkruk Philite met krukhals ø18mm. Mat zwart.
 Door handle Philite. Insert ø18mm. Satin black.
 Türrücker Philite. Drücker Hals ø18mm. Matt Schwarz.
 Béquille Philite avec cou de ø18mm. Noir mat.



0023.029200 Deurkruk Lepel met krukhals ø18mm. Mat zwart.
 Door handle Spoon. Insert ø18mm. Satin black.
 Türrücker Löffel. Drücker Hals ø18mm. Matt Schwarz.
 Béquille Cuillère avec cou de ø18mm. Noir mat.



0023.029300 Deurkruk Posthoorn met krukhals ø18mm. Mat zwart.
 Door handle Post horn. Insert ø18mm. Satin black.
 Türrücker Posthorn. Drücker Hals ø18mm. Matt Schwarz.
 Béquille Cor Postal avec cou de ø18mm. Noir mat.



0023.031500 Deurkruk Peer met krukhals ø18mm. Mat zwart.
 Door handle Pear. Insert ø18mm. Satin black.
 Türrücker Birne. Drücker Hals ø18mm. Matt Schwarz.
 Béquille Poire avec cou de ø18mm. Noir mat.



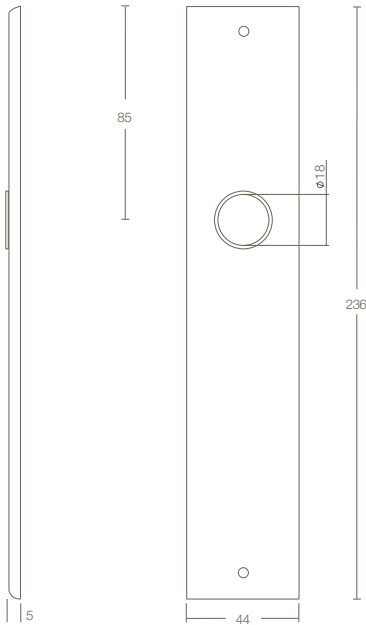

Accessoires
Accessories
Zubehör



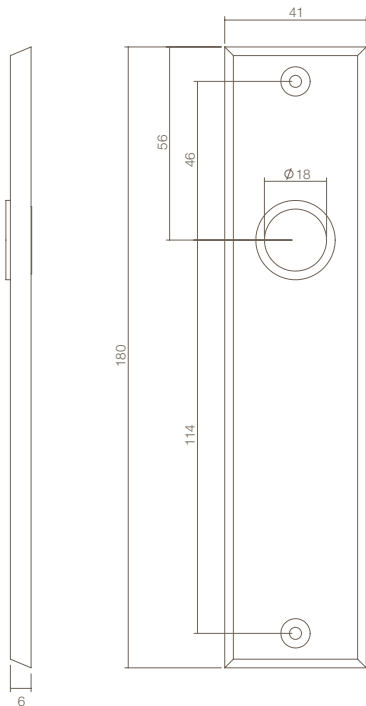

0023.257711		56mm
0023.257724		72mm
0023.257726		55mm
0023.257729		72mm
0023.257736		92mm
0023.257749		55/8mm
0023.257762		57/5mm
0023.257763		63/8mm
0023.257765		72/8mm



0023.256811		56mm
0023.256824		72mm
0023.256826		55mm
0023.256829		72mm
0023.256836		55/8mm
0023.256862		57/5mm
0023.256863		63/8mm
0023.256865		72/8mm

2577

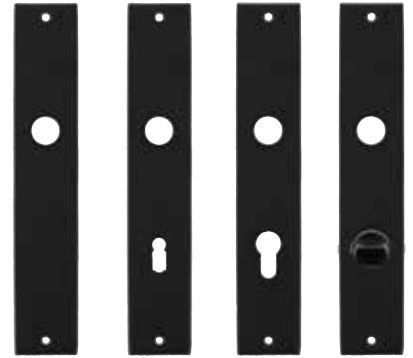
**0023.257711**

Langschild rechthoekig, voor krukken met krukhalshals \varnothing 18mm. Mat zwart. 236mm x 44mm x 5mm.



Renovationplate. For door handles with insert \varnothing 18mm. Satin black. 236mm x 44mm x 5mm.

Renovationslangschild eckig. Für Türdrücker mit Drücker Hals \varnothing 18mm. Matt Schwarz. 236mm x 44mm x 5mm.

Plaque longue rectangulaire. Pour l'usage des béquilles avec cou de \varnothing 18mm. Noir mat. 236mm x 44mm x 5mm.

Optie: Te combineren met deurkrukken op pagina 248 - 249.

Option: Combine with doorhandles from page 248 - 249.

Option: Zu kombinieren mit Türdrücker auf Seite 248 - 249.

Option: Une combinaison possible avec les béquilles de la page 248 - 249.

2568

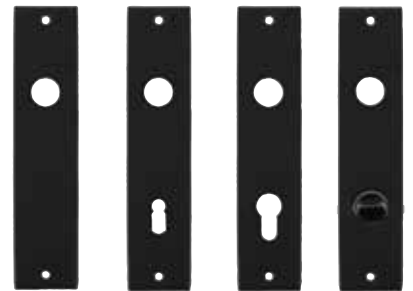
**0023.256811**

Kortschild rechthoekig, voor krukken met krukhalshals \varnothing 18mm. Mat zwart. 180mm x 41mm x 6mm.



Plate for door handles with insert \varnothing 18mm. Satin black. 180mm x 41mm x 6mm.

Kurzschild eckig. Für Türdrücker mit Drücker Hals \varnothing 18mm. Matt Schwarz. 180mm x 41mm x 6mm.

Plaque courte rectangulaire. Pour l'usage des béquilles avec cou de \varnothing 18mm. Noir mat. 180mm x 41mm x 6mm.

Optie: Te combineren met deurkrukken op pagina 248 - 249.

Option: Combine with doorhandles from page 248 - 249.

Option: Zu kombinieren mit Türdrücker auf Seite 248 - 249.

Option: Une combinaison possible avec les béquilles de la page 248 - 249.

Mat zwart - Satin black - Matt Schwarz - Noir mat

Buitendeurbeslag - Rond / Ovaal

0023

Exterior door hardware - Round / Oval

Außertürbeschläge - Rund / Oval

Garnitures de porte extérieure - Rond / Ovale

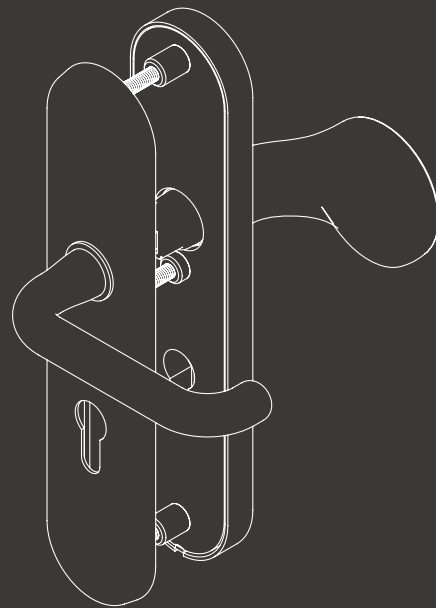

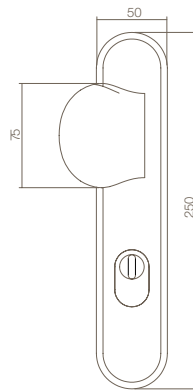
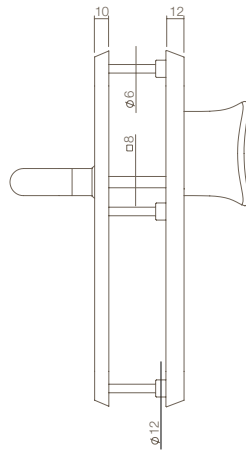
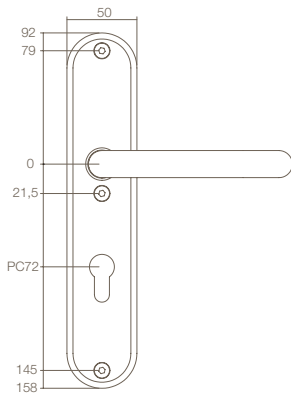

0023.396029		55mm
0023.396036		72mm
0023.396049		92mm

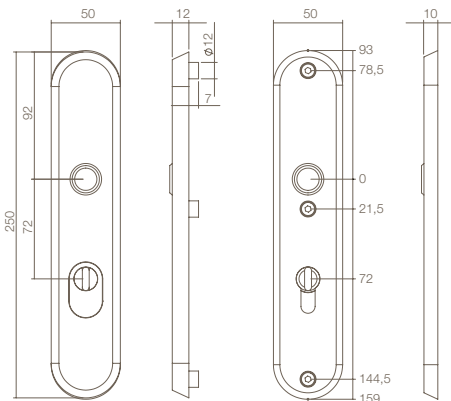

0023.396129		55mm
0023.396136		72mm
0023.396149		92mm



3960

0023.396036

Veiligheidschilden met kerntrekbeveiliging greep/kruk los. Krukhals ϕ 16mm. Links of rechts te monteren. Stift M6 x 8 x 70mm. RVS. Mat zwart.



Security plates pull/lever with cylinder protection. Pull is reversible. Insert ϕ 16mm. Spindle M6 x 8 x 70mm. Stainless steel. Satin black.

Sicherheitsgarnitur Drücker/Griffplatte mit Kernziehschutz. Rechts/links verwendbar. Drücker Hals ϕ 16mm. Stift M6 x 8 x 70mm. Edelstahl. Matt Schwarz.

Garnitures de sécurité avec cache anti-forage et tirant fixe. Tirant réversible. Béquille seule, cou de ϕ 16mm, droite ou gauche. Tige M6 x 8 x 70mm. Inox. Noir mat.



3961

0023.396136

Veiligheidsschilden doorgaand met kerntrek beveiliging. Krukhals ϕ 16mm. RVS. Mat zwart.



Security plates with cylinder protection. Insert ϕ 16mm. Stainless steel. Satin black.

Schutzbeschlag mit Kernziehschutz. Drücker Hals ϕ 16mm. Edelstahl. Matt Schwarz.

Garnitures de sécurité avec cache anti-forage. Béquille, cou de ϕ 16mm. Inox. Noir mat.

Optie:

Alleen te combineren met deurkrukken 0023.057300, 0023.057000, 0023.058300, 0023.058700, 0023.057100

Option:

Only be combined with doorhandles 0023.057300, 0023.057000, 0023.058300, 0023.058700, 0023.057100

Option:

Nur zu kombinieren mit Türdrücker 0023.057300, 0023.057000, 0023.058300, 0023.058700, 0023.057100

Option:

Combinaison seulement possible avec les béquilles 0023.057300, 0023.057000, 0023.058300, 0023.058700, 0023.057100

Accessoires

Accessories
Zubehör



0035.990260	M6	53mm	58 - 64	0099.975183	125mm	75	0099.975440	M6	70mm	<= 50mm	
0035.990261	M6	67mm	68 - 74	0099.975205	150mm	100	0099.975380	M6	90mm	<= 65mm	
0035.990262	M6	73mm	78 - 84				0099.975460	M6	110mm	<= 85mm	
0035.990263	M6	80mm	66 - 72								
0035.990270	M6	90mm	76 - 82								
0035.990265	M6	100mm	86 - 92								
0035.990280	M6	115mm	101 - 107								

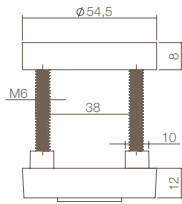

0023.375561

M6



3755

0023.375561

PC veiligheidsrozet rond verdekt, met kerntrekbeveiliging M6. RVS. Mat zwart.



Security euro profile cylinder escutcheon round, with cylinder protection. With invisible fixing M6. Stainless steel. Satin black.



PZ Schutzrosette verdeckt Rund, mit Kernziehschutz M6. Edelstahl. Matt Schwarz.

Entrée de cylindre de haute sécurité, avec cache anti-forage, fixation invisible M6. Inox. Noir mat.

Accessoires

Accessories
Zubehör



			
0099.990120	M6	70mm	58 - 64
0099.990122	M6	80mm	68 - 74
0099.990121	M6	90mm	78 - 84

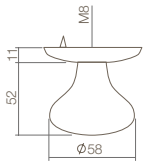
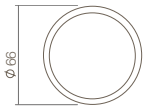

0023.393029

M8



3930

0023.393029

Voordeurknop vast. Doorgaande bevestiging M8. RVS. Mat zwart.



Front door knob fixed. Bolt through fixing M8. Stainless steel. Satin black.

Haustürknopf fest mit durchgehender Befestigung, M8. Edelstahl. Matt Schwarz.

Bouton d'entrée fixe. Fixation traversante M8. Inox. Noir mat.

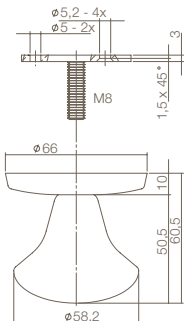

0023.393030

M8



3930

0023.393030

Voordeurknop vast. Eezijdige montage, opschroevend op onderplaat, M8. Bevestiging d.m.v. inbusboutje. RVS. Mat zwart.



Front door knob not turnable with bolt one side fixing M8. Stainless steel. Satin black.

Haustürknopf fest mit einseitiger Befestigung M8. Edelstahl. Matt Schwarz.

Bouton d'entrée fixe. Fixation unilatérale, tournante sur plaque. Fixation par vis pointeau M8. Inox. Noir mat.

Accessoires Accessories Zubehör



0099.997470



Schroefdraad met rvs eindkap t.b.v. bevestiging voordeurknop. 304 RVS geborsteld.

Change spindle for front door knob, including a cover plate. 304 brushed stainless steel.

Gewindesttift mit Hutmutter für Haustürknopf. Edelstahl 304 gebürstet.

Fixation traversante pour bouton d'entrée. Inox mat AISI 304.

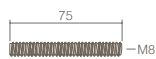

0023.397500

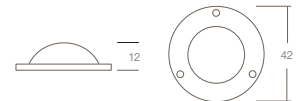

Afdekkplaatje t.b.v. bout. Mat zwart.

Bolt cover plate. Satin black.

Abdeckplatte für Bolzen. Matt Schwarz.

Ce cache boulon couvre la vis du bouton. Noir mat.

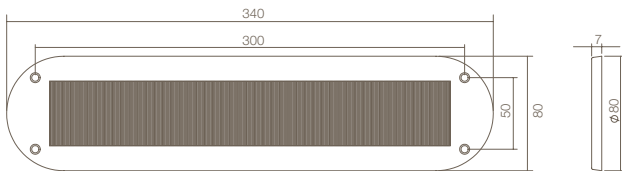
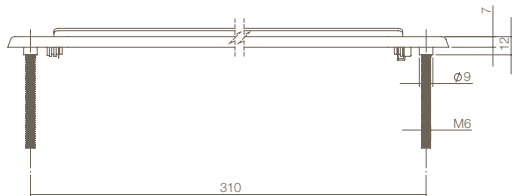
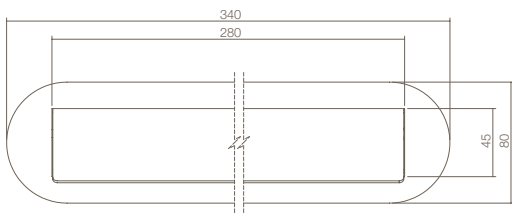

4000



0023.400011

Briefplaat ovaal met regenrand.
Klep half naar buitendraaiend. RVS. Mat zwart.



Oval letter plate with rain edge, opens
half outwards. Stainless steel. Satin black.

Briefeinwurf ovaal mit Tropfkante. Klappe
halb nach aussen öffnend. Edelstahl. Matt Schwarz.

Plaque-à-lettres ovale, s'ouvrant à moitié
vers l'extérieur. Inox. Noir mat.

4015



0023.401502

Tochtwering ovaal met borstel. RVS. Mat zwart.



Draught flap oval with brush. Stainless steel.
Satin black.

Zugklappe oval mit Bürstenleiste.
Edelstahl. Matt Schwarz.

Plaque-à-lettres ovale, anti courants d'air.
Inox. Noir mat.

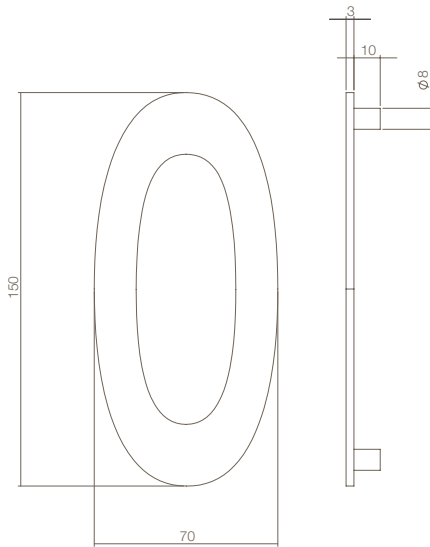

0023.402040	0	150mm
0023.402041	1	150mm
0023.402042	2	150mm
0023.402043	3	150mm
0023.402044	4	150mm
0023.402045	5	150mm
0023.402046	6	150mm
0023.402047	7	150mm
0023.402048	8	150mm
0023.402049	9	150mm

0

0023.40204x



Huiscijfer. Inclusief bevestiging.
RVS. Mat zwart.

House number. Including mounting material.
Stainless steel. Satin black.

Hausnummer breit inkl. Befestigung.
Edelstahl. Matt Schwarz.

Numéro de maison. Fixation fournie.
Inox. Noir mat.

01234
56789

4020

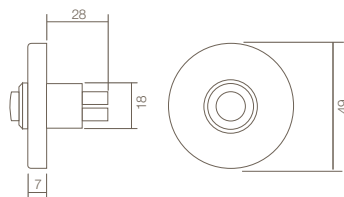

0023.399040



Beldrukker, rond, verdekt. RVS. Mat zwart.

Round concealed bell push. Stainless steel.
Satin black.

Klingelplatte rond, verdekt. Edelstahl.
Matt Schwarz.

Sonnette ronde, fixation invisible. Inox.
Noir mat.

3990

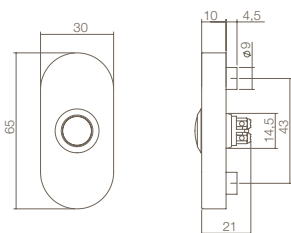

0023.399026



Beldrukker ovaal, verdekt. RVS. Mat zwart.

Concealed oval bell push. Stainless steel.
Satin black.

Klingelplatte oval verdekt. Edelstahl.
Matt Schwarz.

Sonnette ovale, fixation invisible. Inox.
Noir mat.

3990

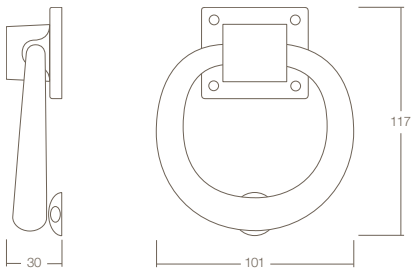
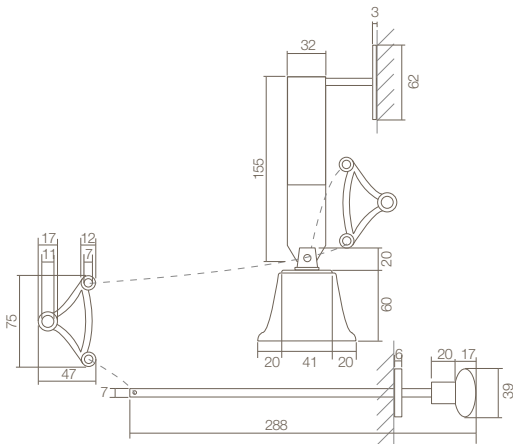

3990

0023.399010

Trekbel set ø80mm. Mat zwart.



Bell pull set. ø80mm. Satin black.

Zugklingel garnitur. ø80mm. Matt Schwarz.

Cloche d'appel complète. ø80mm. Noir mat.



4035

0023.403500

Deurklopper rond. Mat zwart.



Doorknocker round. Satin black.

Türklopper Rund. Matt Schwarz.

Heurtoir de porte rond. Noir mat.



Mat zwart - Satin black - Matt Schwarz - Noir mat

Buitendeurbeslag - Vierkant

0023

Exterior door hardware - Square

Außertürbeschläge - Eckig

Garnitures de porte extérieure - Carrée

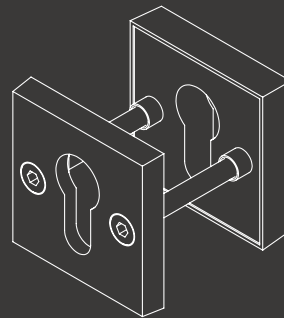

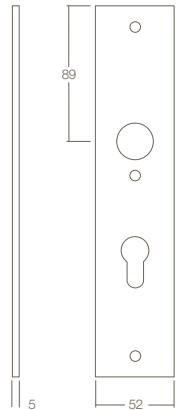
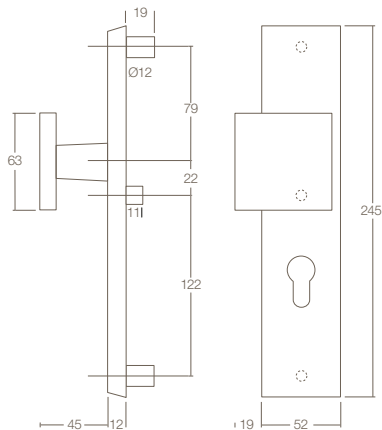

0023.396229		55mm
0023.396236		72mm
0023.396249		92mm

Optie: Alleen te combineren met deurkrukken
0023.057300A, 0023.057000A,
0023.058300A, 0023.058700A, 0023.057100A

Option: Only be combined with doorhandles
0023.057300A, 0023.057000A,
0023.058300A, 0023.058700A, 0023.057100A

Option: Nur zu kombinieren mit Türdrücker
0023.057300A, 0023.057000A,
0023.058300A, 0023.058700A, 0023.057100A

Option: Une combinaison seulement avec les béquilles
0023.057300A, 0023.057000A,
0023.058300A, 0023.058700A, 0023.057100A

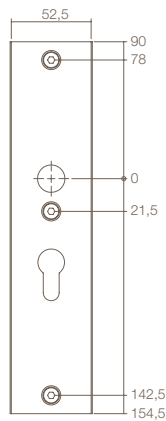
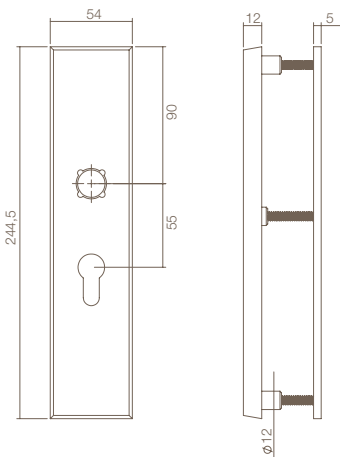

0023.396329		55mm
0023.396336		72mm
0023.396349		92mm

Optie: Alleen te combineren met deurkrukken
0023.057300, 0023.057000,
0023.058300, 0023.058700, 0023.057100

Option: Only be combined with doorhandles
0023.057300, 0023.057000,
0023.058300, 0023.058700, 0023.057100

Option: Nur zu kombinieren mit Türdrücker
0023.057300, 0023.057000,
0023.058300, 0023.058700, 0023.057100

Option: Une combinaison seulement avec les béquilles
0023.057300, 0023.057000,
0023.058300, 0023.058700, 0023.057100

3962



0023.396236

Veiligheidschilden rechthoekig met kerntrek-beveiliging. Greep/geen kruk. Krukhals \varnothing 16mm. Stift M6 x 8 x 70mm. RVS. Mat zwart.



Security plates escutcheon, pull/no lever. Insert \varnothing 16mm. Spindle M6 x 8 x 70mm. Stainless steel. Satin black.



Sicherheitsgarnitur Langschild Drücker/ ohne Griff. Drücker Hals \varnothing 16mm. Stift M6 x 8 x 70mm. Edelstahl. Matt Schwarz.



Garniture de sécurité rectangulaire avec cache anti-forage et tirant fixe. Sans béquille. Cou de \varnothing 16mm. Tige M6 x 8 x 70mm. Inox. Noir mat.

3963



0023.396336

Veiligheidschilden rechthoekig doorgaand met kerntrekbeveiliging. Krukhals \varnothing 16mm. RVS. Mat zwart.



Security plates with cylinder protection. Insert \varnothing 16mm. Stainless steel. Satin black.



Schutzbeschlag mit Kernziehschutz. Drücker Hals \varnothing 16mm. Edelstahl. Matt Schwarz.



Garniture de sécurité rectangulaire avec cache anti-forage. Sans béquille. Cou de \varnothing 16mm. Inox. Noir mat.

Accessoires

Accessories

Zubehör



0035.990260	M6	53mm	58 - 64
0035.990261	M6	67mm	68 - 74
0035.990262	M6	73mm	78 - 84
0035.990263	M6	80mm	66 - 72
0035.990270	M6	90mm	76 - 82
0035.990265	M6	100mm	86 - 92
0035.990280	M6	115mm	101 - 107



0099.975183	125mm	75
0099.975205	150mm	100



0099.975440	M6	70mm	\leq 50mm
0099.975380	M6	90mm	\leq 65mm
0099.975460	M6	110mm	\leq 85mm

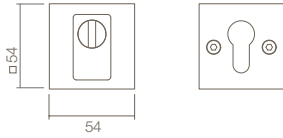
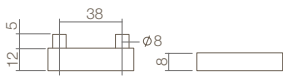

0023.375570 | | M6

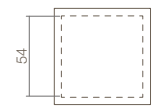
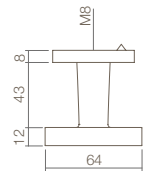

0023.393047 | | M8

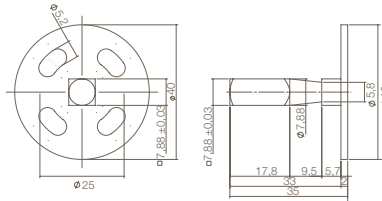
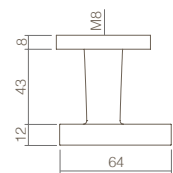

0023.393049 | |

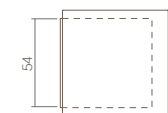

3755

0023.375570 PC veiligheidsrozet vierkant met kerntrek-beveiliging, zichtbare bevestiging, RVS. Mat zwart.



Security euro profile cylinder escutcheon with cylinder protection. With visible fixing. Stainless steel. Satin black.

PZ Sicherheitsrosette eckig mit Kernziehschutz. Sichtbarer Befestigung. Edelstahl. Matt Schwarz.

Entrée de cylindre de haute sécurité carrée avec cache anti-forage. Fixation visible. Inox. Noir mat.



3930

0023.393047 Voordeurknop vast centraal. Doorgaande bevestiging M8. RVS. Mat zwart.



Front door knob fixed on round rose and centered. Bolt through fixing M8. Stainless steel. Satin black

Haustürkноп fest mittig mit durchgehender Befestigung M8. edelstahl. Matt Schwarz.

Bouton d'entrée central fixe. Fixation traversante M8. Inox. Noir mat.



3930

0023.393049 Voordeurknop vast verkröpt. Eenzijdige bevestiging op onderplaat. Bevestiging d.m.v. inbusboutjes. RVS. Mat zwart.



Front door knob fixed and out of centre on round rose and out of the centre. One side fixing. Stainless steel. Satin black

Haustürkноп fest gekröpt mit einseitiger Befestigung. Edelstahl. Matt Schwarz.

Bouton d'entrée déporté fixe. Fixation sur plaque par vis pointeau. Inox. Noir mat.

Accessoires

Accessories

Zubehör



0099.997470

Schroefdraad met rvs eindkap t.b.v. bevestiging voordeurknop.

304 RVS geborsteld.

Change spindle for front door knob, including a cover plate. 304 brushed stainless steel.

Gewindestift mit Hutmutter für Haustürkноп. Edelstahl 304 gebürstet.

Fixation traversante pour bouton d'entrée. Inox mat AISI 304.

0035.990242

0035.990243

0035.990271

0035.990280



M6

76mm

58 - 61

M6

84mm

66 - 69

M6

100mm

82 - 85

M6

115mm

97 - 100

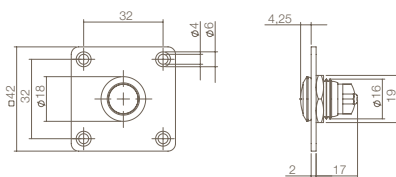
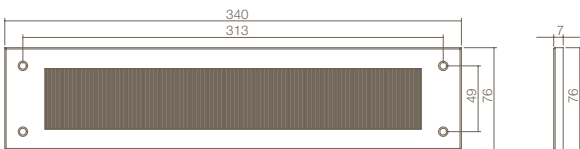
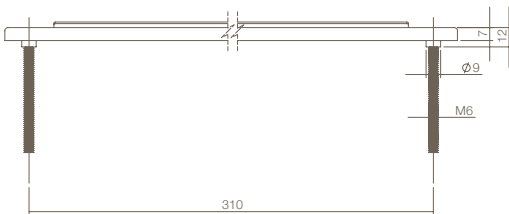
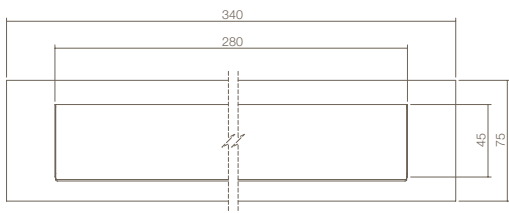

4000



0023.400002

Briefplaat rechthoekig met regenrand.
Klep half naar buitendraaiend. RVS. Mat zwart.



Letter plate square with rain edge,
opens half outwards. Stainless steel. Satin black.

Briefeinwurf rechteckig mit Tropfkante.
Klappe halb nach innen öffnend.
Edelstahl. Matt Schwarz.

Plaque-à-lettres rectangulaire.
S'ouvrant à moitié vers l'extérieur. Inox.
Noir mat.

4015



0023.401501

Tochtwering rechthoek met borstel.
RVS. Mat zwart.



Draught flap rectangular with brush.
Stainless steel. Satin black.

Zugklappe rechteckig mit Bürstenleiste.
Edelstahl. Matt Schwarz.

Plaque-à-lettres anti courants d'air,
rectangulaire. Inox. Noir mat.

3419



0023.341926

Bedrukker vierkant, plat 2mm. RVS. Mat zwart.



Square bell push. Stainless steel. Satin black.

Klingelplatte eckig. Edelstahl. Matt schwarz.

Sonnette carrée, plat 2mm. Inox. Noir mat.





Mat zwart - Satin black - Matt Schwarz - Noir mat

Toebehoren - Deurstoppers

0023

Accessories - Doorstops

Zubehör - Türstopper

Accessoires - Butoirs de porte

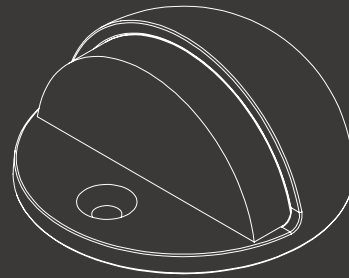

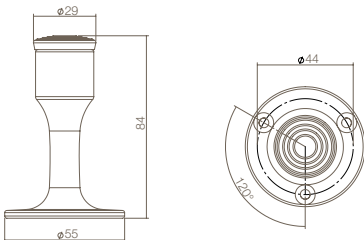
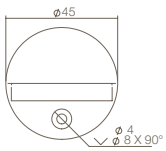
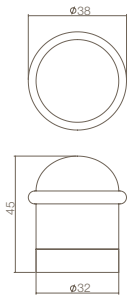

442000

0023.442000 Deurstop met ring. Mat zwart.
Vloermontage.



Doorstop with ring. Satin black.
Floor mounting.

Türstopper mit Ring, Matt Schwarz.
Bodenmontage.

Butoir de porte avec bague. Noir mat.
Pose au sol.



442020

0023.442020 Deurstop rond model. Mat zwart.
Vloermontage.



Doorstop round. Satin black.
Floor mounting.

Türstopper Rund. Matt Schwarz.
Bodenmontage.

Butoir de porte modèle rond. Noir mat.
Pose au sol.



442040

0023.442040 Deurstop recht model. Mat zwart.
Wandmontage.



Door stop straight. Satin black.
Wall mounting.

Türstopper recht. Matt Schwarz.
Wandmontage.

Butoir de porte modèle droit. Noir mat.
Pose mural.

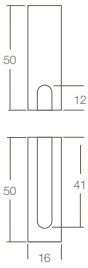

ø14mm

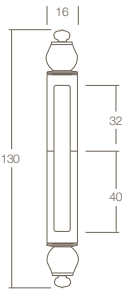

ø14mm



4540

0023.454000

Sierhuls stomp 50/50mm voor paumel ø14mm. Mat zwart.



Decorative hinge cover blunt 50/50mm. Satin black.

Übersteckhüls 50/50mm Stumpf. Matt Schwarz.

Cache-paumelles modern 50/50mm pour paumelles ø14mm. Noir mat.



4540

0023.454001

Sierhuls met knop 32/40mm voor paumel ø14mm. Mat zwart.



Decorative hinge cover 32/40mm. Satin black.

Übersteckhüls 32/40mm. Matt Schwarz.

Cache-paumelles Avec bouton. 32/40mm pour paumelles ø14mm. Noir mat.

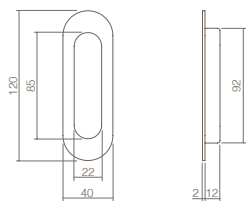

447681



0023.447681 Schuifdeurkom ovaal. 120x40mm.
Blind. RVS. Mat zwart.



Flush pull oval. 120x40mm. Blind.
Stainless steel. Satin black.

Schiebetürmuschel oval. 120x40mm.
Blind. Edielstahl. Matt Schwarz.

Cuvette à bord ovale, 120x40mm. Aveugle.
Inox. Noir mat.

450101

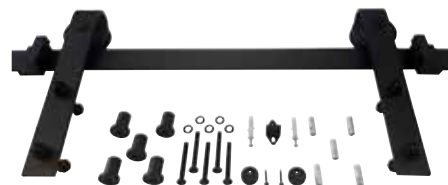

0023.450101 Schuifdeursysteem 2 meter, staal. Mat Zwart.



Sliding door system. 2 meters, steel. Satin black

Schiebetürsystem. 2 meter, Stahl. Matt Schwarz.

Mécanisme de porte coulissante. 2 mètre.
Acier. Noir mat.





Mat zwart - Satin black - Matt Schwarz - Noir mat

Raambeslag - Raamsluitingen

0023

Window fittings - Window closers

Fensterbeschläge - Fenstersicherung

Garnitures de fenêtre - Béquilles de fenêtre

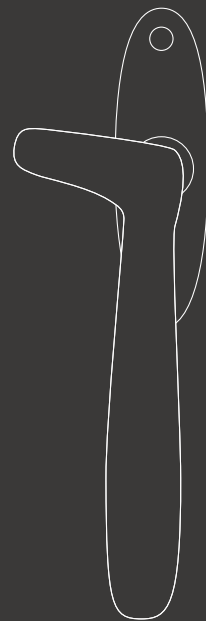

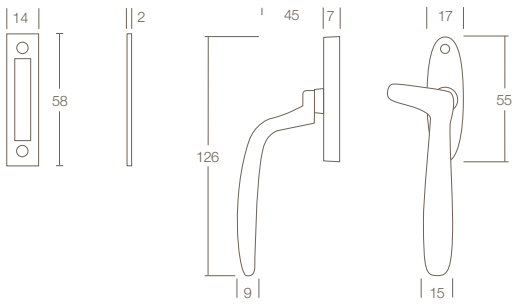

0023.561550A



0023.561550B

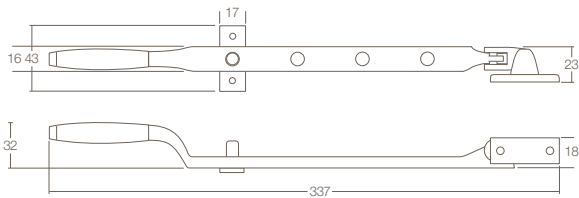

5615

0023.561550A Raamsluiting Dudok, rechts. Mat zwart.

Window closer Dudok, right. Satin black.

Fenstersicherung Dudok, rechts. Matt Schwarz.

Crémone Dudok, droite. Noir mat.



5615

0023.561580 Raamuitzetter Dudok met stelpen. Mat zwart.

Window casement stay with casement stay pin. Satin black.

Fensteraufsteller met Stellstift. Matt Schwarz.

Entrebâilleur Dudok avec cheville de positionnement. Noir mat.

Accessoires

Accessories
Zubehör



0023.561540



0023.561589

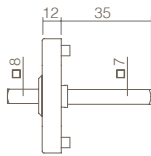
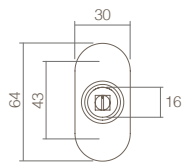
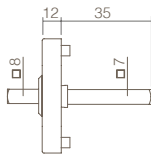
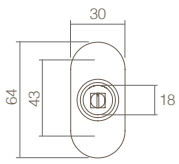

Bern 0023.057300A



Luzern 0023.057000A



Jura 0023.058300A



Jupiter 0023.058700A



Amsterdam 0023.057100A

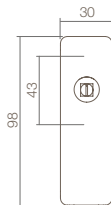
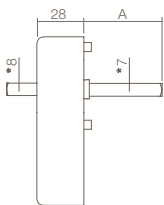

0023.666100

A

32mm
Mat zwart
Satin black
Matt Schwarz

0023.666200

32mm
Mat zwart, structuur
Satin black, grain texture
Matt Schwarz, Struktur
Noir mat, veine

605000

0023.605000



Onderconstructie tbv. raamkruk met hals \varnothing 18mm. Standborging 4x90°. Mat zwart.

Baseplate for window handle with a \varnothing 18mm insert. Mechanism click-stop 4x90° turn. Satin black.

Unterkonstruktion für Fenstergriffe mit \varnothing 18mm Drückerhals. Rasterung: 4x90°. Matt Schwarz.

Sous-construction pour béquille de fenêtre. Cou \varnothing 18mm. Clic-stop 4x90°. Noir mat.



605001

0023.605001



Onderconstructie tbv. raamkruk met hals \varnothing 16mm. Standborging 4x90°. RVS. Mat zwart.

Baseplate for window handle with a \varnothing 16mm insert. Mechanism click-stop 4x90° turn. Stainless steel. Satin black.

Unterkonstruktion für Fenstergriffe mit \varnothing 16mm Drückerhals. Rasterung: 4x90°. Edelstahl. Matt Schwarz.

Sous-construction pour béquille de fenêtre. Cou \varnothing 16mm. Clic-stop 4x90°. Inox. Noir mat.

Optie:

Te combineren met deurhandles 0023.057300A, 0023.057000A, 0023.058300A, 0023.058700A, 0023.057100A

Option:

Combine with doorhandles 0023.057300A, 0023.057000A, 0023.058300A, 0023.058700A, 0023.057100A

Option:

Zu kombinieren mit Türdrücker 0023.057300A, 0023.057000A, 0023.058300A, 0023.058700A, 0023.057100A

Option:

En association avec les béquilles 0023.057300A, 0023.057000A, 0023.058300A, 0023.058700A, 0023.057100A



666100

0023.666100



Afsluitbare onderconstructie tbv. raamkruk met hals \varnothing 16mm. Standborging 4x90°. RVS. Mat zwart.

Lockable Baseplate for window handle with a \varnothing 16mm insert. Mechanism click-stop 4x90° turn. Stainless steel. Satin black.

Abschließbare Unterkonstruktion für Fenstergriffe mit \varnothing 16mm Drückerhals. Rasterung: 4x90°. Edelstahl. Matt Schwarz.

Sous-construction pour béquille de fenêtre avec clé. Cou \varnothing 16mm. Clic-stop 4x90°. Inox. Noir mat.



Mat zwart - Satin black - Matt Schwarz - Noir mat

Toebehoren - Meubelgrepen

0023

Accessories - Furniture handles

Zubehör - Möbelgriffe

Accessoires - Poignées de meuble

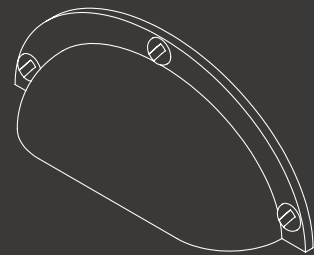

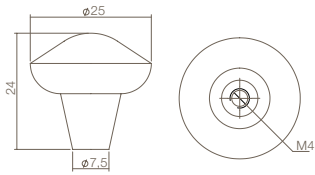

0023.847890
0023.847891
0023.847892

Ø
20mm
25mm
30mm

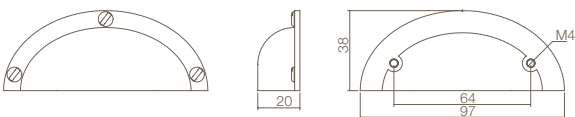
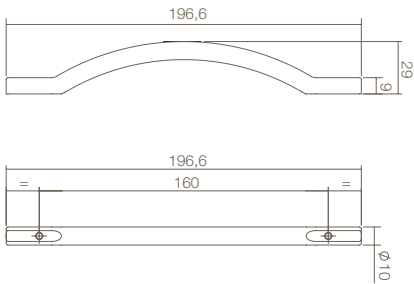
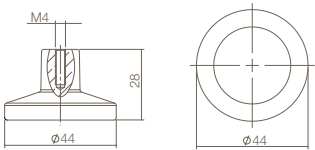

847890

0023.847890

Knop punt rond. Mat zwart.



Knob point round. Satin black.

Knopf Punkt Rund. Matt Schwarz.

Bouton de meuble pointu rond. Noir mat.



847900

0023.847900

Knop rond groot. Mat zwart.



Knob round. Satin black.

Knopf Rund. Matt Schwarz.

Bouton de meuble rond avec prise. Noir mat.



875170

0023.875170

Greep gebogen opliggend ø10/160mm. Mat zwart.



Handle bended ø10/160mm. Satin black.

Möbelgriff ø10/160mm. Matt Schwarz.

Poignée de meuble courbe/droite ø10/160mm. Noir mat.



875250

0023.875250

Kongreep 64/97mm. Mat zwart.



Grip 64/97mm. Satin black.

Möbelgriff 64/97mm. Matt Schwarz.

Poignée Coquille 64/97mm. Noir mat.

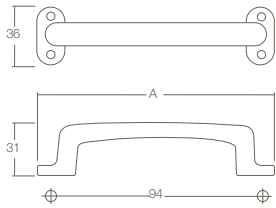

0023.561590

A
110mm

0023.561591

140mm

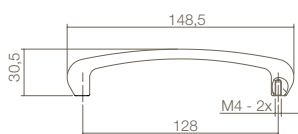
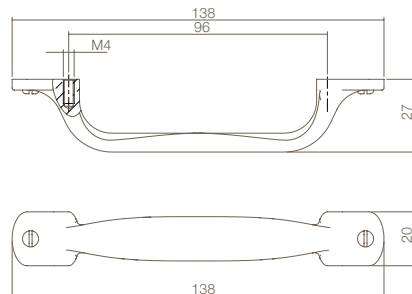
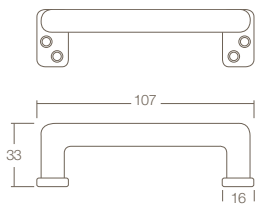

561590

0023.561590

Handgreep 777. Mat Zwart.



Handle 777. Satin black.

Möbelgriff 777. Matt Schwarz.

Poignée 777. Noir mat.



561620

0023.561620

Handgreep recht 107mm. Mat zwart.



Handle straight 107mm. Satin black.

Möbelgriff Recht 107mm. Matt Schwarz.

Poignée modèle droit 107mm. Noir mat.



875280

0023.875280

Handgreep kort 96mm. Mat zwart.



Handle short 96mm. Satin black.

Möbelgriff kurz 96mm. Matt Schwarz.

Poignée de meuble Courte 96mm. Noir mat.



875310

0023.875310

Grep met bolle voet 128mm. Mat zwart.



Grip with convex base 128mm. Satin black.

Möbelgriff mit konvexen Basis 128mm. Matt Schwarz.

Poignée de meuble avec une base convexe 128mm. Noir mat.

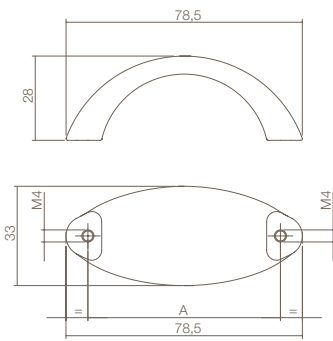

0023.875330

A

64mm

0023.875331

96mm



875330

0023.875330

Greep ellips breed. Mat zwart.



Grip ellipse. Satin black.

Möbelgriff Ellipse. Matt Schwarz.

Poignée de meuble Ellipse. Noir mat.

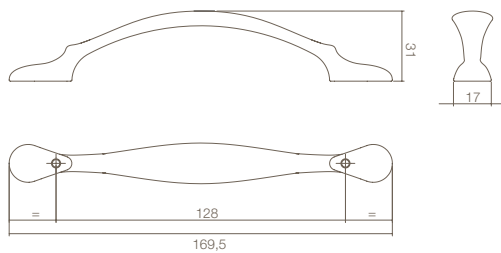

875360

0023.875360

Greep Mats 128mm. Mat zwart.



Grip model Mats 128mm. Satin black.

Möbelgriff Mats 128mm. Matt Schwarz.

Poignée de meuble Mats 128mm. Noir mat.

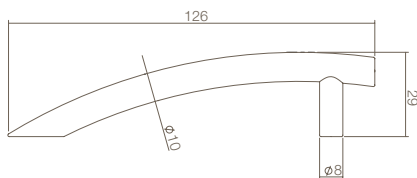

0023.875370

L

130

H.o.H

96mm

H

29

0023.875371

162

128mm

31



875370

0023.875370

Greep half gebogen ø10mm. Mat zwart.



Handle bended ø10mm. Satin black.

Möbelgriff ø10mm. Matt Schwarz.

Poignée de meuble demi courbe ø10mm. Noir mat.

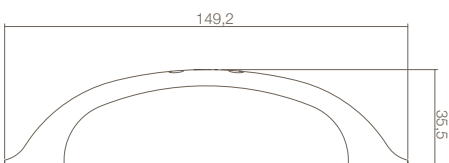
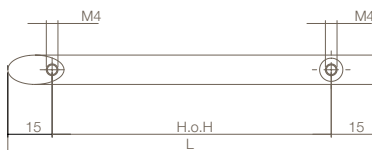

875440

0023.875440

Greep Anna 128mm. Mat zwart.



Grip model Anna 128mm. Satin black.

Möbelgriff Anna 128mm. Matt Schwarz.

Poignée de meuble Anna 128mm. Noir mat.

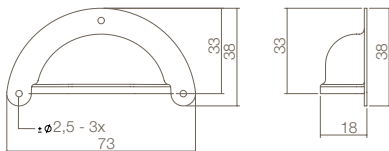
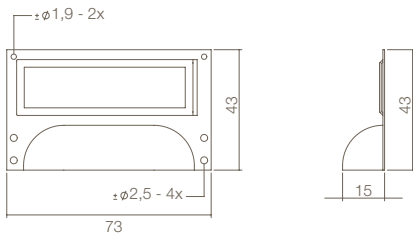
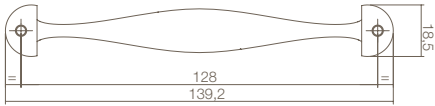

0023.881040	73x33mm
0023.881041	96x43mm

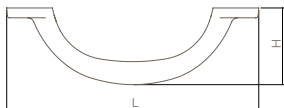

	L	H	B
0023.881100	85mm	28mm	24mm
0023.881101	115mm	35mm	27,5mm
0023.881102	130mm	39mm	31mm
0023.881103	156mm	39mm	35mm



875450

- 0023.875450** Grep Marleen 128mm. Mat zwart.
 Grip model Marleen 128mm. Satin black.
 Möbelgriff Marleen 128mm. Matt Schwarz.
 Poignée de meuble Marleen 128mm. Noir mat.



881000

- 0023.881000** Etiketgrip 73x43mm. Mat zwart.
 Label grip 73x43mm. Satin black.
 Möbelgriff Etikett 73x43mm. Matt Schwarz.
 Poignée Coquille étiquette 73x43mm.
 Noir mat.



881040

- 0023.881040** Schelpgrep. Mat zwart.
 Grip model Shell. Satin black.
 Möbelgriff Schale. Matt Schwarz.
 Poignée Coquille. Noir mat.



881100

- 0023.881100** Grep geperst. Mat zwart.
 Grip pressed. Satin black.
 Möbelgriff gequetscht. Matt Schwarz.
 Poignée de meuble comprimée. Noir mat.



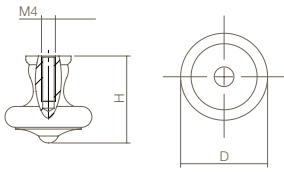

	D	H
0048.855050	20mm	20mm
0048.855051	25mm	25mm
0048.855052	30mm	30mm



855050

0048.855050 Knop punt rond. Smeedijzer. Mat zwart.
 Knob point round. Wrought iron. Satin black.
 Knopf Punkt Rund. Schmiedeeisen. Matt Schwarz.
 Bouton de meuble pointu rond. Fer forgé. Noir mat.

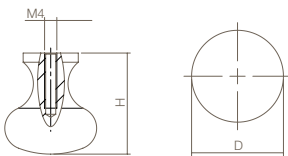

	D	H
0048.855060	25mm	27,5mm
0048.855061	30mm	33mm
0048.855062	35mm	38,5mm



855060

0048.855060 Knop Paddenstoel. Smeedijzer. Mat zwart.
 Knob Mushroom. Wrought iron. Satin black.
 Möbelgriff Pilz. Schmiedeeisen. Matt Schwarz.
 Bouton de meuble Champignon. Fer forgé. Noir mat.

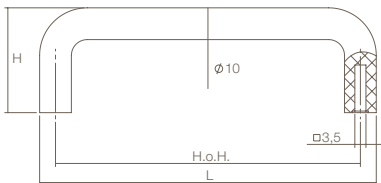

	H.o.H	L	H
0090.903540	64mm	74mm	33
0090.903541	96mm	106mm	33
0090.903542	128mm	138mm	36



903540

0090.903540 Greep nylon zonder bus. Zwart.
 Grip nylon. Black.
 Möbelgriff Nylon. Schwarz.
 Poignée de meuble nylon. Noir.

Mat zwart - Satin black - Matt Schwarz - Noir mat

Toebehoren - Leuninghouders

0023

Accessories - Handrail brackets

Zubehör - Handlaufstützen

Accessoires - Supports de rampe

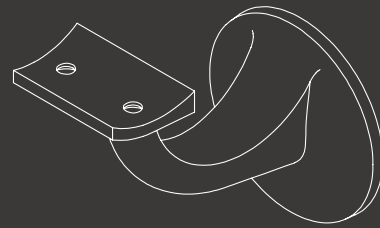

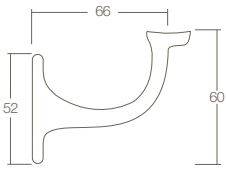

0023.724520

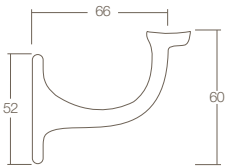

0023.724521

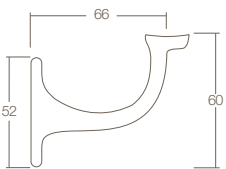

0023.724530



M8

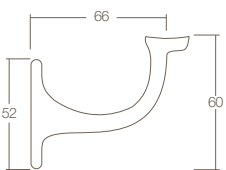

0023.724531



M8



724520

0023.724520

Leuninghouder met schroefgaten. Vlak zadel.
Mat Zwart.



Handrail bracket screw mounting. Flat saddle.
Satin black.

Handlaufstütze schraubbar. Flach Sattel.
Matt Schwarz.

Support de rampe. Plaque avec trous de vis.
Selle plate. Noir mat.



724521

0023.724521

Leuninghouder met schroefgaten. Hol zadel.
Mat Zwart.



Handrail bracket screw mounting. Hollow saddle.
Satin black.

Handlaufstütze, schraubbar. Hohl Sattel.
Matt Schwarz.

Support de rampe. Plaque avec trous de vis.
Selle creuse. Noir mat.



724530

0023.724530

Leuninghouder centraal M8. Vlak zadel.
Blinde montage. Mat zwart.
Incl. bevestigingsmateriaal.



Handrail bracket M8. Flat saddle. Satin black.
Fixing materials included.

Handlaufstütze M8. Flach Sattel. Matt Schwarz.
inkl. Befestigungsmaterial.

Support de rampe avec petite plaque.
Taraudé M8. Selle plate.
Noir mat. Fixations fournies.



724531

0023.724531

Leuninghouder centraal M8. Hol zadel.
Blinde montage. Mat zwart.
Incl. bevestigingsmateriaal.



Handrail bracket M8. Hollow saddle. Satin black.
Fixing materials included.

Handlaufstütze M8. Hohl Sattel. Matt Schwarz.
inkl. Befestigungsmaterial.

Support de rampe avec petite plaque.
Taraudé M8. Selle creuse.
Noir mat. Fixations fournies.

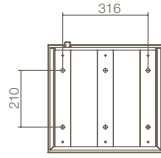
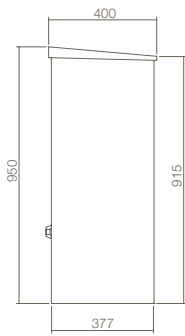
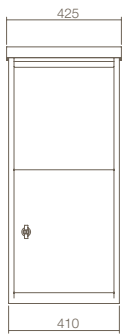

0098.960010

Mat zwart
Satin black
Matt Schwarz
Noire Mat

0098.960011

Donker groen
Dark green
Dunkelgrün
Vert foncé



0098.960010

Pakket Postkast. Geschikt voor twee pakketten.
Automatische vergrendeling, inclusief twee sleutels. Mat zwart.



Parcel Locker. Suitable for two packages.
Auto lock, including two keys. Satin black.

Postkäste Geeignet für zwei Pakete.
Auto-Lock, inkl. zwei Schlüssel Matt Schwarz.

Boîte aux colis extérieur.
Convient pour deux gros colis.
Verrouillage automatique, deux clés fournies.
Noir mat.

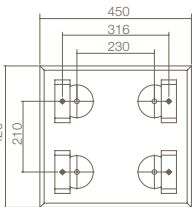
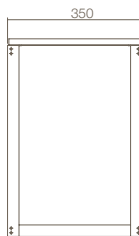
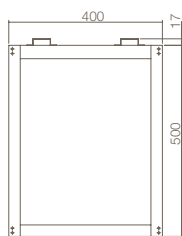
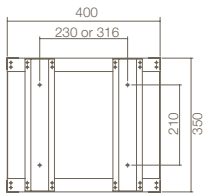

0098.960020

Mat zwart
Satin black
Matt Schwarz
Noire Mat

0098.960021

Donker groen
Dark green
Dunkelgrün
Vert foncé



0098.960025

Grondmontage set voor verankering. RVS.
500mm x 400mm x 350mm (LxBxH).



Ground mounting set for anchoring. Stainless steel. 500mm x 400mm x 350mm (LxWxH).



Befestigungssatz für Verankerung. Edelstahl.
500mm x 400mm x 350mm (LxBxH).

Fondation pour l'ancrage. Inox.
500mm x 400mm x 350mm (LxLxH).



0098.960020

Bodemplaat voor verankering. Mat zwart.



Baseplate for anchoring. Satin black.

Grundplatte für Verankerung. Matt Schwarz.

Plaque de base pour ancrage. Noir mat.

Combinaties

Combinaisons
Kombinationen
Combinaisons

①



②



③



④



Over ons

Bij Intersteel is design meer dan alleen esthetische opsmuk. Het is een kwaliteitskenmerk en staat voor de perfecte synthese van vorm en functie. Het resultaat is het plezier dat je elke keer weer ervaart wanneer je onze producten aanpakt.

Eén van de grootste veranderingen in de afgelopen jaren is toch wel de manier waarop creativiteit niet alleen is ingezet bij de ontwikkeling van producten met een toegevoegde waarde, maar ook heeft bijgedragen aan een verandering van het ontwerpproces. We proberen er voortdurend achter te komen wat de behoeften zijn van onze klanten en we blijven werken aan de ontwikkeling van de juiste oplossing.

About us

At Intersteel, design is more than just esthetic adornment. It's a characteristic of quality and is equal to the perfect synthesis of shape and function. The result is the pleasure you experience every time our products are touched upon.

One of the biggest changes in the past years is the way in which creativity has not only been applied in the development of products with added value, but it has also contributed to a change in the design process. Our team continually attempts to discover the needs of our customer and they remain working on the development towards the exact solution for any one.

Über uns

Bei Intersteel, findet sich Design in den Produkten als ein wichtiges Element wieder. Es ist eine Qualitätsmarke, die für perfekte Synthese aus Form und Funktion steht. Das Resultat ist das Vergnügen, dass Sie immer wieder erwartet, wenn Sie mit unseren Produkten in Kontakt kommen. Eine der größten Veränderungen in den letzten Jahren zeigt uns, dass Kreativität nicht allein in der Entwicklung von Produkten mit Mehrwert liegt, sondern auch zu einer Veränderung im Design-Prozess beigetragen hat. Wir sind ständig bemüht herauszufinden, was die Bedürfnisse unserer Kunden sind, um weiterhin die richtige Lösung für Sie zu entwickeln.

Info

Chez Intersteel, le design est plus qu'un ornement.. C'est un gage de qualité, la synthèse parfaite entre forme et fonction, avec pour résultat le plaisir que vous éprouvez, chaque fois que vous l'utilisez.

Un des plus grands changements de ces dernières années est sans doute la façon dont la créativité a non seulement joué son rôle dans le développement de produits à valeur ajoutée, mais a aussi contribué à la transformation du processus de conception. Nous essayons sans cesse de cerner les besoins de nos clients et de leur offrir la meilleure solution.

Technologie

Intersteel heeft een grote verscheidenheid aan producten en ze gaan lang mee. Dat komt doordat we met behulp van de meest geavanceerde technologieën, prachtige en onderscheidende producten fabriceren.

Technology

The assortment of Intersteel shows great diversity and products are long lasting. This is due to the aid of advanced technologies which enables us to produce distinctive products of great design.

Technik

Intersteel hat eine große Anzahl an verschiedenen Produkten, die fester Bestandteil unseres Sortiments geworden sind. Dies ist das Resultat aus Nutzung neuester Technologien, wodurch viele unterschiedliche und qualitative Produkte entstehen.

Technologie

Intersteel dispose d'une grande variété de produits à grande longévité. En utilisant des technologies de pointe, nous créons des produits de haute qualité.

Kwaliteit

Al onze producten voldoen ruim aan de normen waar het beslag voor de diverse toepassingen aan moet voldoen. Zowel de techniek van het beslag als ook de finishes zijn duurzaam getest.

Quality

All our products meet the standards relevant for the applications of these products. Both the technique and finish of our products are tested for their durability.

Qualität

Alle unsere Produkte, sowohl die Befestigungen als auch die Oberflächen, werden gründlich getestet, um die Standards zu erfüllen.

Qualité

Tous les éléments de nos produits ont été soumis à des tests astreignants, peut-être même les plus rigoureux dans ce domaine.

Historie

Intersteel is van oorsprong een familiebedrijf. Alle generaties terug ligt de oorsprong rond 1900. Sinds de jaren '60, '70 is Van Leeuwen International (toen nog Van Leeuwen Agenturen) gespecialiseerd in exclusief bouw- en interieurbeslag. In de begin periode als agent, maar sinds de laatste decennia verloopt de ontwikkeling van de producten volledig in eigen beheer. Maar ook voor 1900 was er een wens voor exclusief deurbeslag. De jarenlange passie van de familie Van Leeuwen voor bouw- en interieurbeslag is dan ook terug te zien in een omvangrijk assortiment oude sloten, complete slotensets, sleutels en deurkrukken. Pronkstukken vanuit de 15e eeuw tot het einde van de 20e eeuw zijn door u te bezichtigen in het slotenmuseum!

History

Intersteel originally is a family company. All generations back the company originated around 1900. Since the 60's & 70's Van Leeuwen International (formerly Van Leeuwen Agencies) is specialized in exclusive building- and interior hardware. In the beginning period as an agency, but since the last years the development of products is managed by our team. But also before 1900 there was a desire for exclusive door hardware. The years of passion and interest for these products by the Van Leeuwen family is visible in the broad assortment of ancient locks, complete lock sets, keys and door handles. Showpieces from the 15th century until the end of the 20th century can be admired in our gallery of locks.

Geschichte

Intersteel ist ursprünglich ein Familienunternehmen, welches bis in das Jahr 1900 zurück geht. Seit den 60er und 70er Jahren des 20. Jahrhunderts, hat sich Van Leeuwen International (damals noch Van Leeuwen Agentur) ausschließlich auf Bau- und Interieur Beschläge spezialisiert. In der Anfangszeit noch als Händler, doch in den letzten Jahrzehnten durch die Entwicklung neuer Produkte erlangte man auch als Produzent einen Rang. Auch im Jahr 1900 gab es einen Wunsch nach exklusiven Türbeschlägen. Die vielen Jahre Leidenschaft der Familie Van Leeuwen für Bau- und Interieur Beschläge wird auch in einem großen gesammelten Sortiment von alten Schlössern, komplette Schloss-Sets, Schlüssel und Türgriffen gezeigt. Glanzstücke des 15. Jahrhundert bis zum Ende des 20. Jahrhundert lassen sich in dem eigenen Schlossmuseum erkunden.

Histoire

Intersteel est à l'origine une entreprise familiale, créée aux alentours de 1900. Depuis les années 60-70, celle-ci (jusqu' alors appelée Van Leeuwen Agenturen) s'est spécialisée dans les garnitures de portes pour le secteur du BTP. Au début, comme agent mais, depuis les dernières décennies, comme spécialiste autonome du développement de ce type de produits. Avant 1900, il existait déjà une demande de garnitures de porte exclusives. La passion familiale et l'intérêt que Van Leeuwen a toujours porté aux produits utilisés dans la construction, se reflète également dans une vaste gamme de serrures anciennes: des ensembles de verrouillage complets, des clés et des poignées de porte, des pièces datant du 15e siècle jusqu'à la fin du 20e. Toutes sont exposées dans le musée que nous vous invitons à visiter!



Visie en missie

Visie

'Intersteel streeft ernaar om middels het verweven van moderne technologieën en elegant design, de mensen om ons heen een prettige en veilige werk- en woonomgeving te bieden.'

Vision

Intersteel strives to offer a controlled working- and living environment through the interference of multiple technologies and the subsequent safe, functional and elegant designs.

Vision

Intersteel, hat das Bestreben durch die Verflechtung der modernen Technologien und dem eleganten Design, den Menschen um sich herum, ein angenehmes und sicheres Arbeits- und Lebensumfeld zu ermöglichen.

Vision

C'est en combinant différents types de technologies et un design élégant, pratique et sûr que Van Leeuwen International vise à offrir à tout un chacun un cadre de travail et un habitat sécurisé.

Missie

'Onze organisatie richt zich op het succesvol ontwikkelen, produceren en vermarkten van innovatieve hang- en sluitwerkoplossingen voor (professionele en particuliere) eindgebruikers, waarbij wij ons ten alle tijden inzetten ten behoeve van het overtreffen van de verwachtingen van onze interne en externe klanten. Daarbij willen wij voor hen een waardevolle partner zijn en staan wij altijd open voor nieuwe uitdagingen en kansen in de markt.'

Mission

Our organization focuses on successfully developing, producing and marketing our innovative hardware solutions for (professional) end users whereby one always aims to surpass all expectations of our internal and external customers. We wish to be a worthy partner and we are always open to new challenges and chances within our market.

Mission

Unsere Organisation konzentriert sich auf die erfolgreiche Entwicklung, Herstellung und Vermarktung innovativer Lösungen von Schließern und Beschlägen für den gewerblichen und privaten Endverbraucher. Wir fühlen uns verpflichtet, die Erwartungen unserer nationalen und internationalen Kunden zu erfüllen. Ferner möchten wir für Sie ein wichtiger Partner sein, immer offen für neue Herausforderungen und alle Chancen am Markt mit Ihnen gemeinsam umzusetzen und zu nutzen.

Mission

"Notre organisation a pour seul objectif de réussir le développement, la fabrication et la commercialisation de formules innovantes de fermetures et de serrures de portes pour des utilisateurs professionnels et autres. Nous voulons être un partenaire idéal, toujours ouvert à de nouveaux défis et l'opportunités du marché".



Kwaliteit



SKG keurmerk

SKG is het keurmerk dat aangeeft dat een product voldoet aan de eisen die de Stichting Kwaliteit Gevelbouw stelt aan inbraakwerendheid en veiligheid. Dit is een landelijke norm.

SKG control mark

SKG is the control mark which indicates if a product meets the set requirements for the prevention of burglary and safety. This is according to national standards.

SKG Label

SKG ist das Markenzeichen, das darauf hinweist, das ein Produkt den Anforderungen an Einbruch und Sicherheit der Gevelbouw Stiftung entspricht. Dies ist eine nationale Norm, die auch für den deutschen Markt zugelassen ist.

Norme SKG

SKG est la norme nationale qui indique qu'un produit répond aux normes "antivol" prévues par la fondation Stichting Kwaliteit Gevelbouw.

EN 1906

EN1906 is de Europese norm en internationale richtlijn voor deurbeslag. Met deze norm streeft men naar Europese harmonisatie en eenduidigheid voor alle landen binnen de EEG.

EN 1906

EN 1906 is the European norm and international guideline for door hardware. With this standard one strives for European harmonization and clarity for all countries within the EEC.

EN 1906

EN1906 ist der europäische Standard und die internationale Richtlinie für Türbeschläge. Bei diesem Verfahren versucht man die europäische Harmonisierung und Klarheit für alle Länder innerhalb der EU zu erreichen.

EN 1906

EN1906 est la norme Européenne et une directive internationale pour les garnitures de portes. Avec cette méthode, on s'oriente vers une harmonisation Européenne et l'uniformité pour tous les pays de la CEE.



DIN 18273

DIN 18273 FS is een internationale norm voor brandvertragend deurbeslag.

DIN 18273

DIN 18273 FS is an international standard for fire retarding door hardware.

DIN 18273

DIN 18273 FS ist eine internationale Norm für Feuerschutzbeschläge

DIN 18273

DIN 18273 FS est une norme internationale pour les garnitures de portes coupe-feu.



NEN 1770

De NEN 1770 is een standaard norm voor de bedieningshoogte en de breedte van de briefgleuf. Deze norm is van toepassing op al onze briefplaten getoond in dit productoverzicht.

NEN 1770

The NEN 1770 standard refers to the operational height and the width of the mail opening. All these specific products in our product overview meet this standard.

NEN 1770

Die NEN 1770 ist eine Standardnorm für die Höhen und Breiten von Briefeinfwürfen. Dieser Standard gilt für all unsere Briefeinfwürfe, die in diesem Katalog gezeigt werden.

NEN 1770

Le NEN 1770 est une norme standard pour contrôler la hauteur et la largeur de l'ouverture d'une plaque-à-lettres. Cette norme est applicable sur toutes nos plaques-à-lettres présentées dans ce catalogue.



Garantie op functionaliteit

Intersteel onderscheidt zich door het bieden van een optimale service, snelle leveringen en een uitstekende kwaliteit. Om de kwaliteit extra te benadrukken bieden wij onze afnemers op alle producten een functionaliiteitsgarantie van tien jaar. De voorwaarden voor deze garantie kunt u bij ons opvragen.

Warranty on functionality

Intersteel is characterized by its offer of optimal service, quick deliveries and excellent quality. To emphasize our quality we offer our customers a ten years warranty of functionality. The conditions for this warranty are available on request.

Garantie auf die Funktion

Intersteel unterscheidet sich von anderen Anbietern. Wir bieten Ihnen einen optimalen Service, schnelle Lieferzeiten und eine ausgezeichnete Qualität. Um die Qualität sicherzustellen, bieten wir unseren Kunden auf alle Produkte eine Funktionsgarantie von 10 Jahren an.

Garantie de fonctionnalité

Intersteel se distingue en offrant le meilleur service possible, une livraison rapide et une qualité irréprochable. A l'appui de cette qualité, nous offrons sur tous nos produits une garantie de fonctionnalité de dix ans. Les conditions sont obtenues par écrit.



ISO 9001

Sinds 1994 is Intersteel in het bezit van het ISO 9001 certificaat. Deze kwaliteitsstandaard beschrijft het bedrijfsproces en is een garantie voor de constante beheersing van alle facetten van de onderneming. De productie, het assortiment, de service en leveringen voldoen aan hoge en streng gecontroleerde normen.

ISO 9001

Since 2001 Intersteel possesses an ISO 9001 certificate. This standard of quality describes the company process and is a warranty for continuously controlling all aspects of the company. The production, the assortment, the service and deliveries all meet these requirements.

ISO 9001

Seit 1994 ist Intersteel in Besitz des ISO 9001-Zertifikats. Dieser Qualitätsstandard beschreibt die Betriebsprozesse und ist ein Garant für die ständige Kontrolle. Alle Abteilungen des Unternehmens werden nach diesem hohen und strengen Standard geprüft.

ISO 9001

Depuis 1994 Intersteel est titulaire du certificat ISO 9001. Cette norme garantie à ses clients un produit de qualité constante, un degré élevé de fiabilité et un excellent service.

Algemene verkoop- en leveringsvoorwaarden

Algemene verkoop- en leveringsvoorwaarden Van Leeuwen Agenturen B.V., handelend onder Van Leeuwen International. Gedeponeerd bij de Kamer van Koophandel op 20 februari 2015

Artikel 1: Toepasselijkheid

1.1. Tenzij uitdrukkelijk anders is overeen-gekomen, zijn deze voorwaarden van toepassing op alle aanbiedingen, overeenkomsten van koop en verkoop en leveringen van alle goederen en diensten, die door Van Leeuwen International (hierna 'verkoper') in de handel worden gebracht en/of verstrekt. Koper aanvaardt de toepasselijkheid van deze voorwaarden door het enkele feit van zijn opdracht. Algemene of specifieke door de koper gehanteerde Inkoopvoorwaarden worden door de verkoper niet aanvaard en zijn op de door deze voorwaarden beheerste aanbiedingen, overeenkomsten en leveringen niet van toepassing tenzij en nadat de bedoelde Inkoopvoorwaarden uitdrukkelijk schriftelijk door de verkoper (en, indien deze een rechtspersoon is, door een bestuurder daarvan) van toepassing zijn verklaard op enigerlei specifieke transactie.

1.2. Indien schriftelijk uitdrukkelijk anders is overeen-gekomen, gelden Inkoopvoorwaarden van koper slechts voor zover deze niet in strijd zijn met de algemene verkoopvoorwaarden van Van Leeuwen International. In geval van twijfel omtrent de vraag of zodanige strijdigheid aanwezig is, prevaleren de algemene verkoopvoorwaarden van Van Leeuwen International. Aanvaarding op deze wijze van de toepasselijkheid van zodanige Inkoopvoorwaarden zal in geen geval met zich brengen, dat die Inkoopvoorwaarden ook op andere transacties tussen koper en verkoper van toepassing (zullen) zijn. Indien en voor zover een aanbidding en/of overeenkomst tussen koper en verkoper van de door deze voorwaarden beheerste aanbiedingen en/of overeenkomsten afwijkende bepalingen bevat zonder dat de toepasselijkheid van deze voorwaarden uitdrukkelijk is uitgesloten, blijven de overige bepalingen van deze voorwaarden onverminderd van kracht.

1.3. Een ieder die bij Van Leeuwen International goederen bestelt zal gelden als koper, ook indien op verzoek van de koper de factuur van de betreffende levering op naam van een ander wordt gesteld en/of aan deze ander wordt gestuurd en/of de factuur door deze ander wordt betaald. Daarnaast geldt een ieder jegens Van Leeuwen International als koper aan wie levering heeft plaatsgevonden.

Artikel 2: Aanbiedingen, adviezen en bestellingen

2.1. Alle offerten en prijsopgaven zijn vrijblijvend en kunnen door de verkoper herroepen worden, evenwel met dien verstande dat verkoper aan de in schriftelijke prijsopgaven opgegeven netto prijzen is gebonden gedurende een periode van 30 dagen, te rekenen van de verzending van de betreffende prijsopgave. Alle prijzen zijn in netto contant, zonder korting en exclusief ten tijde van de levering verschuldigde belastingen. Wordt een bestelling gedaan zonder dat een prijs uitdrukkelijk overeengekomen is, dan wordt deze ongeacht vroeger gemaakte offerte of vroeger berekende prijs, tegen de ten tijde van de uitvoering der bestelling geldende prijs uitgevoerd.

2.2. Retourzendingen in andere hoeveelheden dan deze verpakkingseenheden worden niet geaccepteerd. Maten en gewichten worden bij benadering en zonder verplichting van Van Leeuwen International opgegeven.

2.3. Verpakking wordt tegen de daarvoor in aanmerking komende kostprijs berekend. Voor geleverde emballage wordt statiegeld in rekening gebracht. Verkoper is indien hij niet aan een ter zake uitgebrachte offerte is gehouden gerechtigd orders niet te accepteren. Hij is in dat geval gehouden koper daarvan bericht te zenden binnen 5 werkdagen, te rekenen van de ontvangst van de order.

2.4. Elke overeenkomst wordt door Van Leeuwen International. aangegaan onder de opschortende voorwaarde, dat de kredietwaardigheid van de koper naar het oordeel van Van Leeuwen International. voldoende blijkt te zijn.

2.5. Een speciale bestelling is een bestelling die buiten het reguliere assortiment van Van Leeuwen International valt. Voor speciale bestellingen gelden afwijkende prijzen en/of levertijden, die schriftelijk per bestelling worden overeengekomen. Afzonderlijk voor een koper door Van Leeuwen International bestelde goederen kunnen niet worden geannuleerd en bij de juiste uitvoering van een speciale bestelling worden deze goederen nimmer door Van Leeuwen International retour genomen. Bij speciale bestellingen onder €150,- netto exclusief BTW, worden kosten in rekening gebracht voor vracht en behandeling.

2.6. Als de aanbidding niet wordt aanvaard, heeft Van Leeuwen

International het recht alle kosten die hij heeft moeten maken om zijn aanbidding te doen bij opdrachtgever in rekening te brengen.

2.7. Opdrachtgever kan geen rechten ontleen aan adviezen en informatie die hij van Van Leeuwen International krijgt als deze geen directe betrekking hebben op de opdracht.

2.8. Opdrachtgever is verantwoordelijk voor de door of namens hem gemaakte tekeningen, berekeningen, ontwerpen en voor de functionele geschiktheid van door of namens hem voorgeschreven materialen.

2.9. Opdrachtgever vrijwaart Van Leeuwen International voor elke aanspraak van derden met betrekking tot het gebruik van door of namens opdrachtgever verstrekte tekeningen, berekeningen, ontwerpen, materialen, monsters, modellen en dergelijke.

2.10. Opdrachtgever mag de materialen die Van Leeuwen International wil gebruiken voordat deze worden verwerkt voor eigen rekening (laten) onderzoeken. Als Van Leeuwen International hierdoor schade lijdt, komt deze voor rekening van opdrachtgever.

Artikel 3: Rechten van intellectueel eigendom

3.1. Tenzij schriftelijk anders is overeengekomen, behoudt Van Leeuwen International de auteursrechten en alle rechten van industrieel eigendom op de door hem gedane aanbiedingen, verstrekte ontwerpen, afbeeldingen, tekeningen, modellen, programmatuur enz.

3.2. De rechten blijven eigendom van Van Leeuwen International ongeacht of aan opdrachtgever voor de vervaardiging ervan kosten in rekening zijn gebracht. Deze gegevens mogen zonder voorafgaande uitdrukkelijke schriftelijke toestemming van Van Leeuwen International niet worden gekopieerd, gebruikt of aan derden getoond. Opdrachtgever is aan Van Leeuwen International per overtreding van deze bepaling een boete verschuldigd van € 25.000. Deze boete kan naast schadevergoeding op grond van de wet worden gevorderd.

3.3. Opdrachtgever moet de aan hem verstrekte gegevens op eerste verzoek binnen de door Van Leeuwen International gestelde termijn retourneren. Bij overtreding van deze bepaling is opdrachtgever aan Van Leeuwen International een boete verschuldigd van € 1.000 per dag. Deze boete kan naast schadevergoeding op grond van de wet worden gevorderd.

Artikel 4: levering

4.1. De levertijd en/of uitvoeringsperiode worden door Van Leeuwen International bij benadering vastgesteld.

4.2. Bij de vaststelling van de levertijd en/of uitvoeringsperiode gaat Van Leeuwen International er van uit dat hij de opdracht kan uitvoeren onder de omstandigheden die hem op dat moment bekend zijn.

4.3. De levertijd en/of uitvoeringsperiode gaat pas in wanneer over alle commerciële en technische details overeenstemming is bereikt, alle noodzakelijke gegevens, definitieve, goedgekeurde tekeningen enz. in het bezit zijn van Van Leeuwen International B.V., de overeengekomen (termijn)betaling is ontvangen én aan de noodzakelijke voorwaarden voor de uitvoering van de opdracht is voldaan.

4.4.1. Als er sprake is van andere omstandigheden dan die welke Van Leeuwen International bekend waren toen hij de levertijd en/of uitvoeringsperiode vaststelde, kan Van Leeuwen International de levertijd en/of uitvoeringsperiode verlengen met de tijd nodig om de opdracht onder deze omstandigheden uit te voeren. Als de werkzaamheden niet in de planning van Van Leeuwen International kunnen worden ingepast, zullen deze worden uitgevoerd zodra zijn planning dit toelaat.

4.4.2. Als er sprake is van meerwerk wordt de levertijd en/of uitvoeringsperiode verlengd met de tijd nodig om de materialen en onderdelen daarvoor te (laten) leveren en om het meerwerk te verrichten. Als het meerwerk niet in de planning van Van Leeuwen International kan worden ingepast, zullen de werkzaamheden worden uitgevoerd zodra de planning dit toelaat.

4.4.3. Als er sprake is van opschorting van verplichtingen door Van Leeuwen International worden de levertijd en/of uitvoeringsperiode verlengd met de duur van de opschorting. Als voortzetting van de werkzaamheden niet in de planning van Van Leeuwen International kan worden ingepast, zullen de werkzaamheden worden uitgevoerd zodra de planning dit toelaat.

4.4.4. Als er sprake is van onwerkbaar weer wordt de levertijd

en/of uitvoeringsperiode verlengd met de daardoor ontstane vertraging.

4.5. Overschrijding van de overeengekomen levertijd en/of uitvoeringsperiode geeft in geen geval recht op schadevergoeding, tenzij dit schriftelijk is overeengekomen.

Artikel 5: Prijswijziging

5.1. Een stijging van kostprijsbepalende factoren ontstaan na het sluiten van de overeenkomst mag door Van Leeuwen International worden doorberekend aan opdrachtgever als de nakoming van de overeenkomst ten tijde van de stijging nog niet is voltooid.

5.2. Opdrachtgever is gehouden de prijsstijging zoals bedoeld in lid 1 te voldoen tegelijk met betaling van de hoofdsom of de eerstvolgende overeengekomen betalingstermijn.

Artikel 6. Leveringsvoorwaarden

6.1. Levering van zaken geschiedt franco vanaf € 150,- ex. btw en ongelost op de door de opdrachtgever aangegeven plaats, met dien verstande dat deze plaats, die in de orderbevestiging schriftelijk moet worden vermeld, zich bevindt op de begane grond (straatniveau). Lossing heeft plaats door en voor rekening van de opdrachtgever, direct na aankomst van de zaken.

6.2. Controle op de kwantiteit en kwaliteit dient door de opdrachtgever onmiddellijk na aankomst van de zaken te geschieden en eventuele klachten uit dien hoofde dienen ogenblikkelijk schriftelijk bij Van Leeuwen International te worden aangemeld. Laat de opdrachtgever dit na, vervalt daarmee het recht uit dien hoofde te reclameren.

Artikel 7. Betalingsvoorwaarden

Alle door ons geleverde zaken blijven, zolang zij niet zijn betaald, ons eigendom totdat het totale orderbedrag door de opdrachtgever is voldaan. Betaling geschiedt binnen 30 dagen netto tenzij schriftelijk anders overeengekomen.

Artikel 8. Aansprakelijkheid

8.1. Van Leeuwen International is niet aansprakelijk voor directe of indirecte schade, door opdrachtgever geleden, ten gevolge van latente gebreken aan geleverde goederen. Van Leeuwen International is ook niet aansprakelijk voor schade ontstaan tijdens transport van de goederen.

8.2. Van Leeuwen International is niet aansprakelijk voor opzichtschaade. Onder opzichtschaade wordt onder andere verstaan, schade die door of tijdens de uitvoering van het werk wordt toegebracht aan zaken waaraan wordt gewerkt of aan zaken die zich bevinden in de nabijheid van de plaats waar wordt gewerkt. Opdrachtgever dient zich desgewenst tegen deze schade te verzekeren.

8.3. Van Leeuwen International is niet aansprakelijk voor bedrijfsschaade, bijvoorbeeld stagnatieschaade en gederfde winst, of voor schade als gevolg van opzet of roekeloosheid van hulppersonen of niet leidinggevende ondergeschikten van Van Leeuwen International.

8.4. Van Leeuwen International is niet aansprakelijk voor schade aan door of namens opdrachtgever aangeleverd materiaal ten gevolge van een niet deugdelijk uitgevoerde bewerking. Op verzoek van opdrachtgever zal Van Leeuwen International de bewerking opnieuw uitvoeren, met door opdrachtgever voor diens rekening aangeleverd nieuw materiaal.

8.5. Opdrachtgever vrijwaart Van Leeuwen International voor alle aanspraken van derden wegens productenaansprakelijkheid als gevolg van een gebrek in een product dat door opdrachtgever aan een derde is geleverd en dat (mede) bestond uit door Van Leeuwen International geleverde producten en/of materialen.

Artikel 9. Garantie

9.1. Van Leeuwen International staat voor een periode van zes maanden na (op)levering of anders overeengekomen voor de goede uitvoering van de overeengekomen prestatie.

9.2. Bestaat de overeengekomen prestatie (mede) uit het bewerken van door opdrachtgever aangeleverd product dan staat Van Leeuwen International voor de in lid 1 genoemde periode in voor de deugdelijkheid van de uitgevoerde bewerking. Als blijkt dat een bewerking niet deugdelijk is uitgevoerd, zal Van Leeuwen International de keuze maken of hij:

- de bewerking opnieuw uitvoert. In dat geval moet opdrachtgever voor eigen rekening nieuw materiaal aanleveren;
- het gebrek herstelt. In dat geval moet opdrachtgever het materiaal franco aan Van Leeuwen International terugzenden;

- opdrachtgever crediteert voor een evenredig deel van de factuur.

9.3. Bestaat de overeengekomen prestatie uit levering van een zaak dan staat Van Leeuwen International gedurende de in lid 1 genoemde periode in voor de deugdelijkheid van de geleverde zaak. Als blijkt dat de levering niet deugdelijk is geweest, dan moet de zaak franco aan Van Leeuwen International worden teruggezonden. Daarna zal Van Leeuwen International de keuze maken of hij:

- de zaak herstelt;
- de zaak vervangt;
- opdrachtgever crediteert voor een evenredig deel van de factuur.

9.4. Bestaat de overeengekomen prestatie (mede) uit de installatie en/of montage van een geleverde zaak dan staat Van Leeuwen International B.V. voor de in lid 1 genoemde periode in voor de deugdelijkheid van de installatie en/of montage. Als blijkt dat de installatie en/of montage niet deugdelijk is uitgevoerd, zal Van Leeuwen International dit herstellen. De eventueel gemaakte reis- en verblijfkosten komen voor rekening van opdrachtgever.

9.5. Voor die onderdelen waarvoor opdrachtgever en Van Leeuwen International dit uitdrukkelijk schriftelijk zijn overeengekomen geldt fabrieksgarantie. Als opdrachtgever gelegenheid heeft gehad kennis te nemen van de inhoud van de fabrieksgarantie zal deze in de plaats treden van garantie op grond van dit artikel.

9.6. Opdrachtgever moet Van Leeuwen International in alle gevallen de gelegenheid bieden een eventueel gebrek te herstellen en/of de bewerking opnieuw uit te voeren.

9.7. Opdrachtgever kan alleen een beroep doen op garantie nadat hij aan al zijn verplichtingen ten opzichte van Van Leeuwen International heeft voldaan.

9.8. Garantie is alleen dan van toepassing wanneer het product in de juiste situatie wordt toegepast, op correcte wijze is gemonteerd, op de juiste wijze wordt gebruikt en onderhouden en wanneer afdoende beschermende maatregelen zijn genomen.

9.9. Geen garantie wordt gegeven zodra gebreken het gevolg zijn van:

- normale slijtage of vervuiling;
- onzorgvuldig handelen of onoordeelkundig gebruik;
- niet of onjuist uitgevoerd onderhoud;
- installatie, montage, wijziging of reparatie door opdrachtgever of door derden.
- defecten aan of onjuiste afstelling van andere producten aan het element of het element zelf.
- gebruik van product in combinatie of samenstelling met producten van derden.

9.10. Geen garantie wordt gegeven op geleverde zaken die niet nieuw waren op het moment van levering of op zaken die door opdrachtgever zijn voorgeschreven of door of namens hem zijn aangeleverd;

9.11. Geen garantie wordt gegeven op het keuren en/of repareren van zaken van opdrachtgever.

Artikel 10: Reclamaties

10.1. Reclames dienen gemotiveerd binnen 5 dagen na de datum van ontvangst van het geleverde product of dienst, schriftelijk ter kennis van de verkoper gebracht te worden. Goederen kunnen slechts door de koper geretourneerd worden na verkregen toestemming van de verkoper. De kosten verbonden aan het retour zenden van de goederen zijn voor rekening van de koper.

10.2. Indien na melding van een reclame uit onderzoek blijkt dat de oorzaak niet aan product van verkoper is te wijten, heeft verkoper het recht om de gemaakte kosten bij de koper in rekening te brengen.

Artikel 11: Niet afgenomen zaken

Wanneer zaken na het verstrijken van de levertijd niet zijn afgenomen, blijven deze ter beschikking staan van opdrachtgever. Niet afgenomen zaken worden voor rekening en risico van opdrachtgever opgeslagen. Van Leeuwen International mag altijd gebruik maken van de bevoegdheid van artikel 6:90 BW.

Artikel 12: Betaling

12.1. Betaling wordt gedaan op de plaats van vestiging van Van Leeuwen International of op een door Van Leeuwen International aangewezen rekening.

12.2. Tenzij anders overeengekomen vindt betaling als volgt plaats:

- a. bij balieoverkoop contant;
- b. in alle overige gevallen binnen dertig dagen na factuurdatum.

12.3. Ongeacht de overeengekomen betalings-condities is opdrachtgever verplicht op verzoek van Van Leeuwen International een naar diens oordeel voldoende zekerheid voor betaling te verstrekken. Als opdrachtgever hier niet binnen de gestelde termijn aan voldoet, raakt hij direct in verzuim. Van Leeuwen International heeft in dat geval het recht de overeenkomst te ontbinden en zijn schade op opdrachtgever te verhalen.

12.4. Het recht van opdrachtgever om zijn vorderingen op Van Leeuwen International te verrekenen is uitgesloten, tenzij er sprake is van faillissement van Van Leeuwen International of de gerechtelijke schuldsanering op Van Leeuwen International van toepassing is.

12.5. De volledige vordering tot betaling is onmiddellijk opeisbaar als:

- a. een betalingstermijn is overschreden;
- b. opdrachtgever failliet is gegaan of surseance van betaling aanvraagt;
- c. beslag op zaken of vorderingen van opdrachtgever wordt gelegd;
- d. opdrachtgever (vennootschap) wordt ontbonden of geliquideerd;
- e. opdrachtgever (natuurlijk persoon) het verzoek doet te worden toegelaten tot de gerechtelijke schuldsanering, onder curatele wordt gesteld of overlijdt.

12.6. Wanneer betaling niet heeft plaatsgevonden binnen de overeengekomen betalingstermijn, is opdrachtgever direct rente aan Van Leeuwen International verschuldigd. De rente bedraagt 12% per jaar, maar is gelijk aan de wettelijke rente als deze hoger is. Bij de renteberekening wordt een gedeelte van de maand gezien als een volle maand.

12.7. Wanneer betaling niet heeft plaatsgevonden binnen de overeengekomen betalingstermijn is opdrachtgever aan Van Leeuwen International alle buitengerechtelijke kosten verschuldigd met een minimum van € 75,-.

De kosten worden berekend op basis van de volgende tabel:

- over de eerste € 3.000,= 15%
- over het meerdere tot € 6.000,= 10%
- over het meerdere tot € 15.000,= 8%
- over het meerdere tot € 60.000,= 5%
- over het meerdere vanaf € 60.000,= 3%

Als de werkelijk gemaakte buitengerechtelijke kosten hoger zijn dan uit bovenstaande berekening volgt, zijn de werkelijk gemaakte kosten verschuldigd.

12.8. Als Van Leeuwen International in een gerechtelijke procedure in het gelijk wordt gesteld, komen alle kosten die hij in verband met deze procedure heeft gemaakt voor rekening van opdrachtgever.

Artikel 13: Eigendomsvoorbehoud en pandrecht

13.1. Na levering blijft Van Leeuwen International eigenaar van geleverde zaken zolang opdrachtgever:

- a. tekortschiet of tekort zal schieten in de nakoming van zijn verplichtingen uit deze overeenkomst of andere gelijksoortige overeenkomsten;
- b. voor verrichte of nog te verrichten werkzaamheden uit zodanige overeenkomsten niet betaalt of zal betalen;
- c. vorderingen die voortvloeien uit het niet nakomen van bovengenoemde overeenkomsten, zoals schade, boete, rente en kosten, niet heeft voldaan.

13.2. Zolang er op geleverde zaken een eigendomsvoorbehoud rust, mag opdrachtgever deze buiten zijn normale bedrijfsuitoefening niet bezwaren.

13.3. Nadat Van Leeuwen International zijn eigendomsvoorbehoud heeft ingeroepen, mag hij de geleverde zaken terug halen. Opdrachtgever staat Van Leeuwen International toe de plaats te betreden waar deze zaken zich bevinden.

13.4. Als Van Leeuwen International geen beroep kan doen op zijn eigendomsvoorbehoud omdat de geleverde zaken zijn vermengd, vervormd of nagetrokken, is opdrachtgever verplicht de nieuw gevormde zaken aan Van Leeuwen International te verpanden.

Artikel 14: Beëindiging

Als opdrachtgever de overeenkomst wil ontbinden zonder dat er sprake is van een tekortkoming van Van Leeuwen International en Van Leeuwen International hiermee instemt, wordt de overeenkomst met wederzijds goedvinden beëindigd. Van Leeuwen International heeft in dat geval recht op vergoeding van alle vermogensschade zoals geleden verlies, gederfde winst en gemaakte kosten.

Artikel 15: Toepasselijk recht en bevoegde rechter

15.1. Het Nederlands recht is van toepassing.

15.2. Het Weens koopverdrag (C.I.S.G.) is niet van toepassing, evenmin als enige andere internationale regeling waarvan uitsluiting is toegestaan.

15.3. Alleen de Nederlandse burgerlijke rechter die bevoegd is in de vestigingsplaats van Van Leeuwen International neemt kennis van geschillen, tenzij dit in strijd is met het dwingend recht. Van Leeuwen International mag van deze bevoegdheidsregel afwijken en de wettelijke bevoegdheidsregels hanteren.

15.4. Partijen kunnen een andere vorm van geschillenbeslechting zoals bijvoorbeeld arbitrage of mediation overeenkomen.

Please contact our export department for our international payment and delivery terms.

Unsere Exportabteilung stellt Ihnen gerne unsere Liefer- und Zahlungsbedingungen zur Verfügung.

S.V.P. contacter notre département Export pour nos conditions de paiement international et nos termes de livraison.

Commerciële medewerkers

Bij Intersteel staat u, onze klant, voorop! Wij vinden het belangrijk u zo goed mogelijk te bedienen en te voldoen aan uw wensen en verwachtingen. Op een klantvriendelijke manier proberen wij u altijd te woord te staan. U kunt ons op werkdagen al vanaf 8:00 uur bereiken tot 17:15 uur. Op vrijdag van 8:00 uur tot 16:00 uur. Onze medewerkers hebben door de jaren heen veel kennis opgebouwd en zullen er alles aan doen om uw vragen te beantwoorden. Tot slot willen we voor u een vertrouwd gezicht creëren, daarom kunt u hieronder de contactgegevens vinden, zowel voor de buitendienst als binnendienst.

Commercial employees

At Intersteel we say, customer first. We find it important to deliver service at the highest level. You can contact us at workdays starting at 8:00 am until 17:15 pm. On Friday at 8:00 am until 16:00 pm. Over the years, our employees built up a lot of knowledge and will do anything to answer your questions. You can find the contact details below.

INTERSTEEL Mitarbeiter

Unser Motto bei Intersteel lautet: Der Kunde ist König. Als unsere Hauptaufgabe verstehen wir es es, Service auf höchstem Niveau zu geben. An Werktagen sind für Sie in der Zeit von 08.00 Uhr bis 17.15 Uhr erreichbar. Am Freitag von 08:00 Uhr bis 16:00 Uhr. Das unten aufgeführte Verkaufsteam von INTERSTEEL freut sich Ihnen durch seine langjährige Berufserfahrung und Kompetenz, mit Ihrem fundiertem Fachwissen gerne weiter zu helfen. Unten finden Sie die Kontaktdaten des Innen und Außendienstes.

Notre équipe commerciaux

Afin de répondre au mieux à votre attente, notre équipe reste à votre service pour toute information. Nous sommes à votre disposition les jours ouvrables entre 8.00 et 17.15 heures. Vendredi jusqu'à 16.00 heures. Vous pouvez trouver les détails pour contact ci-dessous.



Ronald Taling
Commercieel Directeur
Commercial Director
Directeur Commercial
ronald.taling@intersteel.nl
T: +31 (0)6 51 42 58 45



Sebastiaan Klootwijk
Export Manager
bas.klootwijk@intersteel.nl
T: +31 (0)6 21 55 49 50

Accountmanagers



Henk van den Bosch
Accountmanager
henk.vandenbosch@intersteel.nl
T: +31 (0)6 11 38 52 57



Maarten ter Horst
Projectadviseur
Project Advisor
Projektberater
Conseiller de projet
maarten.terhorst@intersteel.nl
T: +31 (0)6 53 99 31 59



George de Beer
Accountmanager
george.debeer@intersteel.nl
T: +31 (0)6 50 24 40 49



Paul Jansen
Accountmanager
paul.jansen@intersteel.nl
T: +31 (0)6 06 50 24 40 46



Marc Pastoors
Accountmanager
marc.pastoors@intersteel.nl
T: +31 (0)6 83 52 83 63

Sales - Verkauf - Vendeur



Henry Gouw
Verkoper Binnendienst
Sales
Verkauf
Vendeur
henry.gouw@intersteel.nl
T: +31 (0)318 47 77 40



Ard van den Bovenkamp
Verkoper Binnendienst
Sales
Verkauf
Vendeur
ard.vandenbovenkamp@intersteel.nl
T: +31 (0)318 47 77 42



Jan Willem Stropkap
Verkoper Binnendienst
Sales
Verkauf
Vendeur
janwillem.stropkap@intersteel.nl
T: +31 (0)318 47 77 41



André Pauw
Medewerker export
Export Sales Professional
Mitarbeiter Export
Employé export
andre.pauw@intersteel.nl
T: +31 (0)318 47 77 50



Neline van den Brink
Ondersteuning Binnendienst
Sales Support
Vertriebsunterstützung
Aide à la vente
neline.vandenbrink@intersteel.nl
T: +31 (0)318 47 77 77



Index

Art.nr.	Pag.	Art.nr.	Pag.	Art.nr.	Pag.	Art.nr.	Pag.	Art.nr.	Pag.	Art.nr.	Pag.	Art.nr.	Pag.
0016.019502	26	0016.038102A	44	0016.168503	34	0016.170202A	37	0016.253511	21	0016.316360	31	0016.393030	50
0016.019502A	26	0016.038102B	44	0016.168505	34	0016.170202B	37	0016.253524	21	0016.316416	29	0016.393031	50
0016.019502B	26	0016.038302	44	0016.168510	34	0016.170402	38	0016.253526	21	0016.316417	29	0016.393033	50
0016.019802	26	0016.038302A	44	0016.168512A	34	0016.170402A	38	0016.253529	21	0016.317116	31	0016.393034	50
0016.019802A	26	0016.038302B	44	0016.168512B	34	0016.170402B	38	0016.253536	21	0016.317117	31	0016.393046	60
0016.019802B	26	0016.038402	44	0016.168602	34	0016.170403	38	0016.253542	21	0016.317160	31	0016.397500	50
0016.019900	13	0016.038402A	44	0016.168602A	34	0016.170511	38	0016.253811	20	0016.317304	14	0016.399010	53
0016.019900A	13	0016.038402B	44	0016.168602B	34	0016.170410	38	0016.253824	20	0016.317316	14	0016.399023	53
0016.019902	26	0016.038800	14	0016.168603	34	0016.170412A	38	0016.253826	20	0016.317317	14	0016.399025	56
0016.019902A	26	0016.038800A	14	0016.168605	34	0016.170412B	38	0016.253828	20	0016.317360	14	0016.399027	53
0016.019902B	26	0016.042000	16	0016.168610	34	0016.170511	47	0016.253829	20	0016.318004	12	0016.399028	56
0016.020002	27	0016.042000A	16	0016.168612A	34	0016.170511A	47	0016.253836	20	0016.318304	15	0016.399029	62
0016.020002A	27	0016.046000	18	0016.168612B	34	0016.170511B	47	0016.253849	20	0016.318316	15	0016.399031	53
0016.020002B	27	0016.046000A	18	0016.168702	34	0016.170526	47	0016.253854	20	0016.318317	15	0016.399032	62
0016.020100	13	0016.046100	18	0016.168702A	34	0016.170526A	47	0016.253862	20	0016.318360	15	0016.399033	62
0016.020100A	13	0016.046100A	18	0016.168702B	34	0016.170536	47	0016.253863	20	0016.318404	17	0016.400001	61
0016.020302	29	0016.168202	33	0016.168703	34	0016.170569	47	0016.253865	20	0016.318416	17	0016.400003	61
0016.020302A	29	0016.168202A	33	0016.168705	34	0016.171202	45	0016.253867	20	0016.318417	17	0016.400004	61
0016.020302B	29	0016.168202B	33	0016.168708	34	0016.171202A	45	0016.256611	22	0016.318460	17	0016.400005	52
0016.020600	12	0016.168203	33	0016.168710	34	0016.171202B	45	0016.256624	22	0016.318504	18	0016.401500	52
0016.020600A	12	0016.168205	33	0016.168712A	34	0016.171203	45	0016.256626	22	0016.318516	18	0016.401503	61
0016.021300	14	0016.168210	33	0016.168712B	34	0016.171205	45	0016.256629	22	0016.318517	18	0016.402020	66
0016.021300A	14	0016.168211	40	0016.168802	35	0016.171208	45	0016.256636	22	0016.318557	18	0016.402021	66
0016.021500	12	0016.168211A	40	0016.168802A	35	0016.171210	45	0016.256662	22	0016.318560	18	0016.402022	66
0016.021500A	12	0016.168211B	40	0016.168802B	35	0016.171212A	45	0016.256663	22	0016.318604	13	0016.402023	66
0016.021600	12	0016.168212A	33	0016.168803	35	0016.171212B	45	0016.256665	22	0016.318616	13	0016.402024	66
0016.021600A	12	0016.168212B	33	0016.168805	35	0016.171302	45	0016.256667	22	0016.318616	26	0016.402025	66
0016.022200	15	0016.168224	40	0016.168810	35	0016.171302A	45	0016.257011	22	0016.318617	27	0016.402026	66
0016.022200A	15	0016.168226	40	0016.168812A	35	0016.171302B	45	0016.257024	22	0016.318657	13	0016.402027	66
0016.022500	14	0016.168229	40	0016.168812B	35	0016.171303	45	0016.257026	22	0016.318660	13	0016.402028	66
0016.022500A	14	0016.168236	40	0016.168902	35	0016.171305	45	0016.257029	22	0016.318904	16	0016.402029	66
0016.023102	27	0016.168265	40	0016.168902A	35	0016.171308	45	0016.257036	22	0016.318916	16	0016.402501	66
0016.023102A	27	0016.168265	40	0016.168902B	35	0016.171310	45	0016.257062	22	0016.318960	16	0016.402502	66
0016.023102B	27	0016.168269	40	0016.168903	35	0016.171602	38	0016.257063	22	0016.322004	14	0016.402503	66
0016.023400	13	0016.168302	33	0016.168905	35	0016.171602A	38	0016.257065	22	0016.347616	33	0016.403500	53
0016.023400A	13	0016.168302A	33	0016.168910	35	0016.171602B	38	0016.257067	22	0016.347617	33	0016.404002	66
0016.023400B	13	0016.168302B	33	0016.168912A	35	0016.171603	38	0016.257111	23	0016.347618	33	0016.405525	56
0016.024300	17	0016.168303	33	0016.168912B	35	0016.171605	38	0016.257124	23	0016.347658	33	0016.405530	112
0016.024300A	17	0016.168303	33	0016.168912B	35	0016.171610	38	0016.257126	23	0016.347659	33	0016.405531	112
0016.024300B	17	0016.168305	33	0016.168920	35	0016.171610	38	0016.257126	23	0016.347659	33	0016.405531	112
0016.025400	12	0016.168310	33	0016.169302A	35	0016.171612A	38	0016.257129	23	0016.347660	33	0016.405532	112
0016.025400A	12	0016.168310	33	0016.169302A	35	0016.171612A	38	0016.257129	23	0016.347660	33	0016.405532	112
0016.025400B	12	0016.168311	41	0016.169302B	35	0016.171612B	38	0016.257136	23	0016.347816	45	0016.426180	92
0016.026302	28	0016.168311A	41	0016.169303	35	0016.171702	46	0016.257136	23	0016.347817	45	0016.426190	92
0016.026302A	28	0016.168311A	41	0016.169303	35	0016.171702A	46	0016.257142	23	0016.347858	45	0016.426191	93
0016.026302B	28	0016.168311B	41	0016.169305	35	0016.171702A	46	0016.257142	23	0016.347858	45	0016.426191	93
0016.028402	27	0016.168312A	33	0016.169310	35	0016.171702B	46	0016.257149	23	0016.347860	45	0016.426192	93
0016.028402A	27	0016.168312A	33	0016.169310	35	0016.171702B	46	0016.257149	23	0016.347860	45	0016.426192	93
0016.028402B	27	0016.168312B	33	0016.169312A	35	0016.171802	46	0016.257163	23	0016.347916	45	0016.426193	93
0016.028402C	27	0016.168324	41	0016.169312B	35	0016.171802A	46	0016.257165	23	0016.370001	15	0016.442000	88
0016.029602	28	0016.168326	41	0016.169402	36	0016.171802B	46	0016.257167	23	0016.370557	13	0016.442010	88
0016.029602A	28	0016.168329	41	0016.169402A	36	0016.171902	36	0016.257711	23	0016.370557	26	0016.442020	88
0016.029602B	28	0016.168336	41	0016.169402B	36	0016.171902A	36	0016.257724	23	0016.370557	44	0016.442040	88
0016.030802	29	0016.168345	41	0016.169403	36	0016.171902B	36	0016.257726	23	0016.370558	13	0016.447600	90
0016.030802A	29	0016.168365	41	0016.169405	36	0016.171903	36	0016.257729	23	0016.370560	13	0016.454400	86
0016.030802B	29	0016.168369	41	0016.169410	36	0016.172502	39	0016.257736	23	0016.370560	44	0016.454001	86
0016.031102	30	0016.168380	41	0016.169412A	36	0016.172502A	39	0016.257749	23	0016.370660	13	0016.561500	76
0016.031102A	30	0016.168383	41	0016.169412B	36	0016.172502B	39	0016.257762	23	0016.370960	12	0016.561510A	76
0016.031102B	30	0016.168390A	41	0016.169702	38	0016.172503	39	0016.257763	23	0016.371059	15	0016.561510B	76
0016.032300	18	0016.168390B	41	0016.169702A	38	0016.172505	39	0016.257765	23	0016.371060	15	0016.561520A	76
0016.032300A	18	0016.168391A	41	0016.169702B	38	0016.172510	39	0016.257767	23	0016.375060	51	0016.561520B	76
0016.032300B	18	0016.168391B	41	0016.169703	38	0016.173502	39	0016.258011	20	0016.375100	51	0016.561530A	76
0016.032400	18	0016.168402	33	0016.169705	38	0016.173502A	39	0016.258024	20	0016.375140	60	0016.561530B	76
0016.032602	31	0016.168402A	33	0016.169710	38	0016.173502B	39	0016.258026	20	0016.381929	55	0016.561540	75
0016.032602A	31	0016.168402B	33	0016.169802	37	0016.173503	39	0016.258029	20	0016.381936	55	0016.561550A	75
0016.032602B	31	0016.168403	33	0016.169802A	37	0016.173505	39	0016.258036	20	0016.381949	55	0016.561550B	75
0016.037100	16	0016.168405	33	0016.169802B	37	0016.173510	39	0016.258063	20	0016.382029	54	0016.561560A	75
0016.037100A	16	0016.168410	33	0016.169803	37	0016.212600	33	0016.258065	20	0016.382036	54	0016.561560B	75
0016.037500	15	0016.168411	41	0016.169805	37	0016.253011	21	0016.258067	20	0016.382049	54	0016.561580	79
0016.037500A	15	0016.168411A	41	0016.169808	37	0016.253024	21	0016.314104	30	0016.382129	55	0016.561581	79
0016.037700	15	0016.168411B	41	0016.169810	37	0016.253026	21	0016.314716	30	0016.382136	55	0016.561589	79
0016.037700A	15	0016.168412A	33	0016.170102	37	0016.253029	21	0016.314717	30	0016.382149	55	0016.561590	97
0016.037800	1												

Art.nr.	Pag.	Art.nr.	Pag.	Art.nr.	Pag.	Art.nr.	Pag.	Art.nr.	Pag.	Art.nr.	Pag.	Art.nr.	Pag.
0016.562007	83	0018.020600A	114	0018.317316	115	0018.881000	149	0019.037800	158	0019.173503	174	0019.314716	170
0016.562020	80	0018.021700	114	0018.317317	115	0018.881040	149	0019.037800A	158	0019.173505	174	0019.314717	170
0016.562025	80	0018.021700A	114	0018.317360	115	0018.881041	149	0019.037802	171	0019.173510	174	0019.314760	170
0016.562030	82	0018.022200	116	0018.318304	116	0018.881100	149	0019.037802A	171	0019.212600	172	0019.315604	154
0016.562040A	81	0018.022200A	116	0018.318316	116	0018.881101	149	0019.038102	181	0019.212602	180	0019.315616	154
0016.562040B	81	0018.022500	115	0018.318317	116	0018.881102	149	0019.038102A	181	0019.212611	161	0019.315617	154
0016.562070A	81	0018.022500A	115	0018.318360	116	0018.881103	149	0019.038102B	181	0019.212624	161	0019.315619	154
0016.562070B	81	0018.031800	114	0018.318416	126	0019.019502	166	0019.038302	181	0019.212636	161	0019.315620	154
0016.605000	74	0018.031800A	114	0018.318417	126	0019.019502A	166	0019.038302A	181	0019.253011	160	0019.315660	154
0016.605011	70	0018.032300	118	0018.318460	126	0019.019502B	166	0019.038302B	181	0019.253024	160	0019.316316	171
0016.605013	70	0018.032300A	118	0018.318504	118	0019.019702	166	0019.038702	171	0019.253026	160	0019.316317	171
0016.605014	70	0018.032400	118	0018.318516	118	0019.019702A	166	0019.038702A	171	0019.253029	160	0019.316360	171
0016.605020	71	0018.032400A	118	0018.318517	118	0019.019702B	166	0019.038702B	171	0019.253036	160	0019.317304	155
0016.605070	71	0018.037100	117	0018.318560	118	0019.019711	176	0019.038800	155	0019.253049	160	0019.317316	155
0016.605090	71	0018.037100A	117	0018.318904	117	0019.019711A	176	0019.038800A	155	0019.253062	160	0019.317317	155
0016.617050	72	0018.037500	116	0018.318916	117	0019.019711B	176	0019.042000	157	0019.253063	160	0019.317360	155
0016.661600	74	0018.037500A	116	0018.318960	117	0019.019724	176	0019.042000A	157	0019.253064	160	0019.318304	156
0016.661620	72	0018.037700	116	0018.322004	117	0019.019726	176	0019.169202	173	0019.253065	160	0019.318316	156
0016.661630	72	0018.037700A	116	0018.370001	116	0019.019729	176	0019.169202A	173	0019.253067	160	0019.318317	156
0016.661645	73	0018.037802	119	0018.370002	116	0019.019736	176	0019.169202B	173	0019.253069	160	0019.318360	156
0016.661646	73	0018.037802A	119	0018.370101	117	0019.019762	176	0019.169211	177	0019.253811	160	0019.318361	181
0016.661650A	77	0018.038202	126	0018.370557	114	0019.019763	176	0019.169211A	177	0019.253826	160	0019.318404	158
0016.661651A	77	0018.038202A	126	0018.370660	114	0019.019765	176	0019.169211B	177	0019.253828	160	0019.318416	181
0016.661651B	77	0018.038202B	126	0018.370960	118	0019.019767	176	0019.169224	177	0019.253829	160	0019.318417	181
0016.661652A	78	0018.038800	115	0018.371059	126	0019.019811	176	0019.169236	177	0019.253836	160	0019.318460	181
0016.661652B	78	0018.038800A	115	0018.371060	126	0019.019811A	176	0019.169265	177	0019.253854	160	0019.318604	154
0016.692600	106	0018.042000	117	0018.397500	128	0019.019811B	176	0019.169502	172	0019.253855	160	0019.318616	154
0016.692611	106	0018.042000A	117	0018.401500	128	0019.019824	176	0019.169502A	172	0019.253862	160	0019.318617	154
0016.692612	106	0018.046000	118	0018.401503	130	0019.019829	176	0019.169502B	172	0019.253863	160	0019.318657	154
0016.692613	106	0018.046000A	118	0018.426192	146	0019.019836	176	0019.169511	177	0019.253865	160	0019.318660	154
0016.692620	106	0018.046100	118	0018.426193	146	0019.019863	176	0019.169511A	177	0019.253867	160	0019.318904	157
0016.724520	110	0018.046100A	118	0018.442000	144	0019.019865	176	0019.169511B	177	0019.256611	162	0019.318916	157
0016.724521	110	0018.253111	122	0018.442040	144	0019.019867	176	0019.169524	177	0019.256624	162	0019.318960	157
0016.724540	110	0018.253124	122	0018.561540	134	0019.019902	167	0019.169526	177	0019.256626	162	0019.322004	157
0016.724541	110	0018.253126	122	0018.561550A	134	0019.019902A	167	0019.169529	177	0019.256629	162	0019.370001	157
0016.752530	101	0018.253129	122	0018.561550B	134	0019.019902B	167	0019.169536	177	0019.256636	162	0019.370002	157
0016.847600	101	0018.253136	122	0018.561560A	134	0019.020002	167	0019.169565	177	0019.256662	162	0019.370003	157
0016.847601	102	0018.257011	123	0018.561560B	134	0019.020002A	167	0019.169569	177	0019.256663	162	0019.370101	157
0016.847661	101	0018.257024	123	0018.561580	137	0019.020002B	167	0019.169602	172	0019.256665	162	0019.370557	154
0016.847662	101	0018.257026	123	0018.561581	137	0019.020100	154	0019.169602A	172	0019.257111	163	0019.370558	154
0016.847663	101	0018.257029	123	0018.561589	137	0019.020100A	154	0019.169602B	172	0019.257124	163	0019.370560	154
0016.847664	101	0018.257036	123	0018.561600	148	0019.022200	156	0019.169902	172	0019.257126	163	0019.370660	154
0016.847700	102	0018.257062	123	0018.561601	148	0019.022200A	156	0019.169902A	172	0019.257129	163	0019.370960	166
0016.847701	102	0018.257063	123	0018.561620	148	0019.022500	155	0019.169902B	172	0019.257136	163	0019.371060	156
0016.847702	102	0018.257065	123	0018.561640	148	0019.022500A	155	0019.170002	173	0019.257149	163	0019.375060	185
0016.847771	102	0018.257067	123	0018.562000	139	0019.023102	167	0019.170002A	173	0019.257162	163	0019.375100	185
0016.847773	102	0018.257111	123	0018.562001	139	0019.023102A	167	0019.170002B	173	0019.257162	163	0019.375130	185
0016.847774	102	0018.257124	123	0018.562002	139	0019.023102B	167	0019.170302	173	0019.257163	163	0019.375140	196
0016.847801	102	0018.257126	123	0018.562004	139	0019.023400	154	0019.170302A	173	0019.257165	163	0019.381929	189
0016.847802	102	0018.257129	123	0018.562007	138	0019.023400A	154	0019.170302B	173	0019.257167	163	0019.381936	189
0016.847803	102	0018.257136	123	0018.562020	138	0019.023702	181	0019.170502	174	0019.257611	162	0019.381949	189
0016.847821	102	0018.257162	123	0018.562030	138	0019.025400	154	0019.170502A	174	0019.257624	162	0019.382036	188
0016.847822	102	0018.257163	123	0018.562035	139	0019.025400A	154	0019.170502B	174	0019.257626	162	0019.382049	188
0016.847823	102	0018.257165	123	0018.562036	140	0019.026302	169	0019.170503	174	0019.257629	162	0019.382129	189
0016.875040	97	0018.257167	123	0018.562060A	141	0019.026302A	169	0019.170505	174	0019.257662	162	0019.382136	189
0016.875041	97	0018.257711	124	0018.562060B	141	0019.026302B	169	0019.170510	174	0019.257663	162	0019.382429	199
0016.875042	97	0018.257724	124	0018.562061A	141	0019.027700	155	0019.170511	178	0019.257665	162	0019.382436	199
0016.875250	97	0018.257726	124	0018.562061B	141	0019.027700A	155	0019.170511A	178	0019.257711	163	0019.382449	199
0016.875270	97	0018.257729	124	0018.605000	133	0019.027700B	155	0019.170511B	178	0019.257724	163	0019.382529	199
0016.875280	98	0018.257736	124	0018.605011	132	0019.029502	168	0019.170526	178	0019.257726	163	0019.382536	199
0016.875290	98	0018.257762	124	0018.605013	132	0019.029502A	168	0019.170536	178	0019.257729	163	0019.384629	188
0016.875310	98	0018.257763	124	0018.605070	132	0019.029502B	168	0019.170569	178	0019.257736	163	0019.384636	188
0016.875330	98	0018.257765	124	0018.605190	133	0019.029602	168	0019.171402	180	0019.257749	163	0019.384649	188
0016.875340	99	0018.257767	124	0018.661640	133	0019.029602A	168	0019.171402A	180	0019.257762	163	0019.393030	184
0016.875360	99	0018.258011	122	0018.661650A	135	0019.029602B	168	0019.171402B	180	0019.257763	163	0019.393031	184
0016.875370	99	0018.258024	122	0018.661650B	135	0019.030202	168	0019.171502	180	0019.257765	163	0019.393033	184
0016.875371	99	0018.258026	122	0018.661651A	135	0019.030202A	168	0019.171502A	180	0019.257767	163	0019.393046	196
0016.875372	99	0018.258029	122	0018.661651B	135	0019.030202B	168	0019.171502B	180	0019.258011	161	0019.397500	184
0016.875390	99	0018.258036	122	0018.661652A	136	0019.031102	170	0019.172502	174	0019.258024	161	0019.399027	187
0016.875400	100	0018.258062	122	0018.661652B	136	0019.031102A	170	0019.172502A	174	0019.258026	161	0019.39902	

Art.nr.	Pag.	Art.nr.	Pag.	Art.nr.	Pag.	Art.nr.	Pag.	Art.nr.	Pag.
0019.401500	186	0019.724520	234	0023.057300A	246	0023.340316	247	0023.875170	276
0019.401503	197	0019.724521	234	0023.057302	238	0023.340317	247	0023.875250	276
0019.402020	192	0019.847600	226	0023.057302A	238	0023.340319	247	0023.875280	277
0019.402021	192	0019.847601	226	0023.057302B	238	0023.340357	247	0023.875310	277
0019.402022	192	0019.847661	226	0023.058300	246	0023.357360	247	0023.875330	278
0019.402023	192	0019.847662	226	0023.058300A	246	0023.341004	247	0023.875331	278
0019.402024	192	0019.847663	226	0023.058302	238	0023.341016	238	0023.875360	278
0019.402025	192	0019.847664	226	0023.058302A	238	0023.341017	238	0023.875370	278
0019.402026	192	0019.847700	226	0023.058302B	238	0023.341019	238	0023.875371	278
0019.402027	192	0019.847701	226	0023.058700	246	0023.341060	238	0023.875440	278
0019.402028	192	0019.847702	226	0023.058700A	246	0023.341926	262	0023.875450	279
0019.402029	192	0019.875040	226	0023.058702	238	0023.370001	249	0023.881000	279
0019.402501	192	0019.875041	226	0023.058702A	238	0023.370101	249	0023.881040	279
0019.402502	192	0019.875042	226	0023.058702B	238	0023.370557	249	0023.881041	279
0019.402503	192	0019.875043	226	0023.171002	242	0023.370560	249	0023.881100	279
0019.403500	187	0019.875045	226	0023.171002A	242	0023.375561	253	0023.881101	279
0019.405525	186	0019.875050	227	0023.171002B	242	0023.375570	261	0023.881102	279
0019.426180	224	0019.875060	227	0023.171102	242	0023.393029	254	0023.881103	279
0019.426190	224	0019.875061	227	0023.171102A	242	0023.393030	254	0035.990242	261
0019.426192	224	0019.875110	227	0023.171102B	242	0023.393047	261	0035.990243	261
0019.426193	224	0019.875130	227	0023.171202	242	0023.393049	261	0035.990260	260
0019.442000	218	0019.875140	228	0023.171202A	242	0023.396029	252	0035.990261	260
0019.442010	218	0019.875170	228	0023.171202B	242	0023.396036	252	0035.990262	260
0019.442020	218	0019.875240	228	0023.171302	242	0023.396049	252	0035.990263	260
0019.447600	222	0019.875250	228	0023.171302A	242	0023.396129	252	0035.990265	260
0019.454000	216	0019.875260	229	0023.171302B	242	0023.396136	252	0035.990270	260
0019.561500	212	0019.875270	229	0023.256811	250	0023.396149	252	0035.990271	261
0019.561510A	212	0019.875280	229	0023.256824	250	0023.396229	260	0035.990280	260
0019.561510B	212	0019.875300	229	0023.256826	250	0023.396236	260	0048.855050	280
0019.561520A	212	0019.875310	229	0023.256829	250	0023.396249	260	0048.855051	280
0019.561520B	212	0019.875330	229	0023.256836	250	0023.396329	260	0048.855052	280
0019.561530A	212	0019.875331	229	0023.256862	250	0023.396336	260	0048.855060	280
0019.561530B	212	0019.875350	229	0023.256863	250	0023.396349	260	0048.855061	280
0019.561540	205	0019.875380	229	0023.256865	250	0023.397500	254	0048.855062	280
0019.561550A	205	0023.019902	239	0023.256867	250	0023.399010	257	0090.903540	280
0019.561550B	205	0023.019902A	239	0023.257711	250	0023.399026	256	0090.903541	280
0019.561560A	205	0023.019902B	239	0023.257724	250	0023.399040	256	0090.903542	280
0019.561560B	205	0023.020002	239	0023.257726	250	0023.400002	262	0098.960010	283
0019.561580	206	0023.020002A	239	0023.257729	250	0023.400011	255	0098.960011	283
0019.561581	206	0023.020002B	239	0023.257736	250	0023.401501	262	0098.960020	283
0019.561589	206	0023.020100	248	0023.257749	250	0023.401502	255	0098.960021	283
0019.561590	231	0023.020100A	248	0023.257762	250	0023.402040	256	0098.960025	283
0019.561591	231	0023.020302	240	0023.257763	250	0023.402041	256	0099.370000	15
0019.561601	231	0023.020302A	240	0023.257765	250	0023.402042	256	0099.975000	189
0019.561620	231	0023.020302B	240	0023.257767	250	0023.402043	256	0099.975001	189
0019.561640	232	0023.022500	248	0023.268811	243	0023.402044	256	0099.975002	189
0019.561600	232	0023.022500A	248	0023.268826	243	0023.402045	256	0099.975183	252
0019.562001	211	0023.023102	239	0023.268829	243	0023.402046	256	0099.975205	252
0019.562002	207	0023.023102A	239	0023.268836	243	0023.402047	256	0099.975343	161
0019.562004	207	0023.023102B	239	0023.268865	243	0023.402048	256	0099.975363	161
0019.562007	207	0023.023400	248	0023.316416	240	0023.402049	256	0099.975364	161
0019.562020	207	0023.023400A	248	0023.316417	240	0023.403500	257	0099.975380	40
0019.562030	207	0023.026302	239	0023.316460	240	0023.442000	266	0099.975387	161
0019.562035	208	0023.026302A	239	0023.317304	248	0023.442020	266	0099.975382	161
0019.562036	209	0023.026302B	239	0023.317316	248	0023.442040	266	0099.975381	161
0019.562060A	210	0023.029200	249	0023.317317	248	0023.447681	268	0099.975440	40
0019.562060B	210	0023.029200A	249	0023.317360	248	0023.450101	268	0099.975460	40
0019.562070A	210	0023.029200B	249	0023.318304	248	0023.454000	267	0099.990120	51
0019.562070B	210	0023.029300	249	0023.318316	248	0023.454001	267	0099.990121	51
0019.605000	204	0023.029300A	249	0023.318317	248	0023.561550A	272	0099.990122	51
0019.605020	202	0023.029300B	249	0023.318360	248	0023.561550B	272	0099.997470	184
0019.605090	202	0023.029700	249	0023.318404	248	0023.561580	272		
0019.605190	202	0023.029700A	249	0023.318416	248	0023.561590	277		
0019.617050	203	0023.029700B	249	0023.318417	248	0023.561591	277		
0019.661645	203	0023.031500	249	0023.318460	248	0023.561620	277		
0019.661646	203	0023.031500A	249	0023.318516	242	0023.605000	273		
0019.661650A	213	0023.037800	248	0023.318517	242	0023.605001	273		
0019.661650B	213	0023.037800A	248	0023.318560	242	0023.666100	273		
0019.661651A	213	0023.037800B	248	0023.318604	249	0023.666200	273		
0019.661651B	213	0023.057000	246	0023.318616	249	0023.724520	282		
0019.661652A	214	0023.057000A	246	0023.318617	249	0023.724521	282		
0019.661652B	214	0023.057002	238	0023.318660	249	0023.724530	282		
0019.692600	220	0023.057002A	238	0023.318904	249	0023.724531	282		
0019.692611	220	0023.057002B	238	0023.318916	249	0023.847890	276		
0019.692612	220	0023.057100	246	0023.318960	249	0023.847891	276		
0019.692613	220	0023.057100A	246	0023.322004	249	0023.847892	276		
0019.692620	220	0023.057300	246	0023.340304	247	0023.847900	276		

Ook van Intersteel



Signature: **Sliced** *Arjan Moors*

Exclusief deurbeslag van Intersteel, ontworpen door product- en interieur ontwerper Arjan Moors. Geïnspireerd op de eenvoud van het alledaagse.

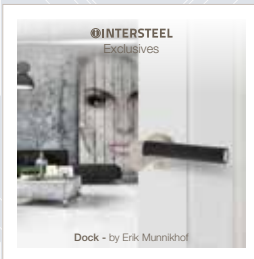

Dock line By Erik Munnikhof

Industrieel ontwerper Erik Munnikhof ontwierp deze exclusieve lijn modulair opgebouwd deurbeslag voor Intersteel.

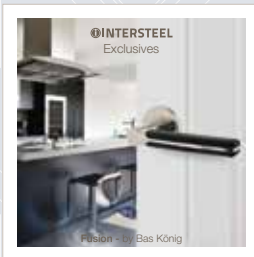

Fusion By Bas König

Geïnspireerd door zijn passie voor fusion koken, ontwierp Intersteel designer Bas König de Fusion lijn deur- en raambeslag. Een unieke combinatie van verschillende materialen, de strakke look van roestvast staal en de prettige feel van zwart rubber.

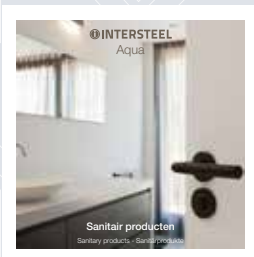

INTERSTEEEL Aqua

Een complete lijn badkamer- en toiletaccessoires van Intersteel. Deze producten zijn vervaardigd uit hoogwaardig roestvrij staal (AISI 316) met oog voor een functioneel en modern design!



INTERSTEEEL Veiligheidsbeslag

Een selectie uit het brede assortiment veiligheidsbeslag van Intersteel. Hoogwaardig roestvast staal met- en zonder kerntrekbeveiliging.



INTERSTEEEL Essentials 2 RVS

Het totale assortiment van ons RVS programma. Hoogwaardig roestvast staal in de kwaliteit die u van Intersteel gewend bent.

Disclaimer

Disclaimer

Voor de in dit productoverzicht opgenomen gegevens aanvaarden wij geen enkele aansprakelijkheid, evenmin als voor eventuele druk- en zetfouten en afwijkingen in de kleurproducties.

Wijzigingen in constructie en uitvoeringen van onze producten worden nadrukkelijk voorbehouden.

Gehele of gedeeltelijke overname van de in deze catalogus gepubliceerde gegevens uitsluitend na schriftelijke toestemming onzerzijds.

INTERSTEEL is een internationaal geregistreerd beeldmerk.

Disclaimer

We do not accept any responsibility for the facts noted in this product summary, nor for any misprints and defects in colour productions.

Alterations in construction and design of our products are emphatically reserved.

Information from this summary, whether complete or partial, can only be used by obtaining our written permission.

INTERSTEEL is an international registered trademark.

Anmerkung

Die in dieser Programmübersicht angegebenen Maße, Abbildungen und Zeichnungen sind unverbindlich. Modell- und Maßänderungen, sowie konstruktive Veränderungen behalten wir uns vor.

Erfahrungsgemas können Druckfarben nicht immer den Farbton originalgetreu wiedergeben. Farbabweichungen sind daher möglich.

Für Druckfehler und Irrtümer die bei der Erstellung dieser Programmübersicht unterlaufen sind, ist jede Haftung ausgeschlossen.

INTERSTEEL ist ein eingetragene internationale Warenzeichen.

Remarques

Nous nous réservons le droit de modifier nos produits, leurs finitions et leurs dimensions ; les dimensions, illustrations et caractéristiques sont mentionnées à titre indicatif. Les photos de ce catalogue ne sont pas contractuelles. Ce catalogue est notre propriété.

Nous en avons les droits pour tous les pays.

Toutes reproductions, même partielles, ne peuvent être faites qu'avec notre accord écrit.

INTERSTEEL est une marque déposée internationale.

Intersteel • Utrechtsestraatweg 220 • 3911 TX Rhenen • Postbus 128 • 3910 AC Rhenen
T +31 (0)318 - 47 77 77 • **F** +31 (0)318 - 47 77 78 • **E** info@intersteel.nl • **W** www.intersteel.nl

